

# HUMALOG- insulin lispro injection, solution

## A-S Medication Solutions

-----

### HIGHLIGHTS OF PRESCRIBING INFORMATION

These highlights do not include all the information needed to use HUMALOG safely and effectively. See full prescribing information for HUMALOG.

**HUMALOG (insulin lispro) injection, for subcutaneous or intravenous use**  
**Initial U.S. Approval: 1996**

### INDICATIONS AND USAGE

HUMALOG is a rapid acting human insulin analog indicated to improve glycemic control in adult and pediatric patients with diabetes mellitus. (1)

### DOSAGE AND ADMINISTRATION

- See Full Prescribing Information for important administration instructions. (2.1, 2.2, 2.3, 2.4)
- Subcutaneous injection (2.2):
  - Administer HUMALOG<sup>®</sup> U-100 or U-200 by subcutaneous injection into the abdominal wall, thigh, upper arm, or buttocks within 15 minutes before a meal or immediately after a meal.
  - Rotate injection sites to reduce risk of lipodystrophy and localized cutaneous amyloidosis.
- Continuous subcutaneous infusion (Insulin Pump) (2.2):
  - Refer to the insulin infusion pump user manual to see if HUMALOG can be used. Use in accordance with the insulin pump instructions for use.
  - Administer HUMALOG U-100 by continuous subcutaneous infusion using an insulin pump in a region recommended in the instructions from the pump manufacturer.
  - Rotate infusion sites to reduce risk of lipodystrophy and localized cutaneous amyloidosis.
  - DO NOT administer HUMALOG U-200 by continuous subcutaneous infusion.
- Intravenous Infusion (2.2):
  - Administer HUMALOG U-100 by intravenous infusion ONLY after dilution and under medical supervision. DO NOT administer HUMALOG U-200 by intravenous infusion.
- The dosage of HUMALOG must be individualized based on the route of administration and the individual's metabolic needs, blood glucose monitoring results and glycemic control goal. (2.3)
- Do not perform dose conversion when using the HUMALOG U-100 or U-200 prefilled pens. The dose window shows the number of insulin units to be delivered and no conversion is needed. (2.1, 2.3)
- Do not mix HUMALOG U-200 with any other insulin. (2.4)

### DOSAGE FORMS AND STRENGTHS

Injection: 100 units/mL (U-100) is available as: (3)

- 10 mL multiple-dose vial
- 3 mL multiple-dose vial
- 3 mL single-patient-use KwikPen<sup>®</sup> prefilled pen
- 3 mL single-patient-use Tempo Pen<sup>™</sup> prefilled pen
- 3 mL single-patient-use Junior KwikPen<sup>®</sup> prefilled pen
- 3 mL single-patient-use cartridges

Injection: 200 units/mL (U-200) is available as: (3)

- 3 mL single-patient-use KwikPen<sup>®</sup> prefilled pen

### CONTRAINDICATIONS

- Do not use during episodes of hypoglycemia. (4)
- Do not use in patients with hypersensitivity to insulin lispro or any of the excipients in HUMALOG. (4)

### WARNINGS AND PRECAUTIONS

- *Never share* a HUMALOG prefilled pen, cartridge, reusable pen compatible with Lilly 3 mL cartridges, or syringe between patients, even if the needle is changed. (5.1)
- *Hyperglycemia or Hypoglycemia with Changes in Insulin Regimen*: Make changes to a patient's insulin regimen (e.g., insulin strength, manufacturer, type, injection site or method of administration) under close medical supervision with increased frequency of blood glucose monitoring. (5.2)
- *Hypoglycemia*: May be life-threatening. Monitor blood glucose and increase monitoring frequency with

changes to insulin dosage, use of glucose lowering medications, meal pattern, physical activity; in patients with renal or hepatic impairment; and in patients with hypoglycemia unawareness. (5.3, 7, 8.6, 8.7)

- *Hypoglycemia Due to Medication Errors*: Accidental mix-ups between insulin products can occur. Instruct patients to check insulin labels before injection. Do not transfer HUMALOG U-200 from the HUMALOG KwikPen to a syringe as overdosage and severe hypoglycemia can result. (5.4)
- *Hypersensitivity Reactions*: May be life-threatening. Discontinue HUMALOG, monitor and treat if indicated. (5.5)
- *Hypokalemia*: May be life-threatening. Monitor potassium levels in patients at risk of hypokalemia and treat if indicated. (5.6)
- *Fluid Retention and Heart Failure with Concomitant Use of Thiazolidinediones (TZDs)*: Observe for signs and symptoms of heart failure; consider dosage reduction or discontinuation if heart failure occurs. (5.7)
- *Hyperglycemia and Ketoacidosis Due to Insulin Pump Device Malfunction*: Monitor glucose and administer HUMALOG U-100 by subcutaneous injection if pump malfunction occurs. (5.8)

---

#### ADVERSE REACTIONS

---

Adverse reactions associated with HUMALOG include hypoglycemia, allergic reactions, injection site reactions, lipodystrophy, pruritus, and rash. (6.1)

**To report SUSPECTED ADVERSE REACTIONS, contact Eli Lilly and Company at 1-800-LillyRx (1-800-545-5979) or FDA at 1-800-FDA-1088 or [www.fda.gov/medwatch](http://www.fda.gov/medwatch).**

---

#### DRUG INTERACTIONS

---

- *Drugs that may increase the risk of hypoglycemia*: antidiabetic agents, ACE inhibitors, angiotensin II receptor blocking agents, disopyramide, fibrates, fluoxetine, monoamine oxidase inhibitors, pentoxifylline, pramlintide, salicylates, somatostatin analog (e.g., octreotide), and sulfonamide antibiotics (7).
- *Drugs that may decrease the blood glucose lowering effect*: atypical antipsychotics, corticosteroids, danazol, diuretics, estrogens, glucagon, isoniazid, niacin, oral contraceptives, phenothiazines, progestogens (e.g., in oral contraceptives), protease inhibitors, somatropin, sympathomimetic agents (e.g., albuterol, epinephrine, terbutaline), and thyroid hormones (7).
- *Drugs that may increase or decrease the blood glucose lowering effect*: alcohol, beta-blockers, clonidine, lithium salts, and pentamidine (7).
- *Drugs that may blunt the signs and symptoms of hypoglycemia*: beta-blockers, clonidine, guanethidine, and reserpine (7).

**See 17 for PATIENT COUNSELING INFORMATION, FDA-approved patient labeling and FDA-approved patient labeling.**

**Revised: 2/2024**

---

## FULL PRESCRIBING INFORMATION: CONTENTS\*

### 1 INDICATIONS AND USAGE

### 2 DOSAGE AND ADMINISTRATION

2.1 Important Administration Instructions

2.2 Administration Instructions for the Approved Routes of Administration

2.3 Dosage Recommendations

2.4 Dosage Modifications for Drug Interactions

2.5 Instructions for Mixing with Other Insulins

### 3 DOSAGE FORMS AND STRENGTHS

### 4 CONTRAINDICATIONS

### 5 WARNINGS AND PRECAUTIONS

5.1 Never Share a HUMALOG Prefilled Pen, Cartridge, Reusable Pen Compatible with Lilly 3 mL Cartridges<sup>1</sup>, or Syringe Between Patients

5.2 Hyperglycemia or Hypoglycemia with Changes in Insulin Regimen

- 5.3 Hypoglycemia
- 5.4 Hypoglycemia Due to Medication Errors
- 5.5 Hypersensitivity Reactions
- 5.6 Hypokalemia
- 5.7 Fluid Retention and Heart Failure with Concomitant Use of PPAR-gamma Agonists
- 5.8 Hyperglycemia and Ketoacidosis Due to Insulin Pump Device Malfunction

## **6 ADVERSE REACTIONS**

- 6.1 Clinical Trials Experience
- 6.2 Postmarketing Experience

## **7 DRUG INTERACTIONS**

## **8 USE IN SPECIFIC POPULATIONS**

- 8.1 Pregnancy
- 8.2 Lactation
- 8.4 Pediatric Use
- 8.5 Geriatric Use
- 8.6 Renal Impairment
- 8.7 Hepatic Impairment

## **10 OVERDOSAGE**

## **11 DESCRIPTION**

## **12 CLINICAL PHARMACOLOGY**

- 12.1 Mechanism of Action
- 12.2 Pharmacodynamics
- 12.3 Pharmacokinetics

## **13 NONCLINICAL TOXICOLOGY**

- 13.1 Carcinogenesis, Mutagenesis, Impairment of Fertility
- 13.2 Animal Toxicology and/or Pharmacology

## **14 CLINICAL STUDIES**

- 14.1 Type 1 Diabetes – Adults and Pediatric Patients Aged 12 years and Older
- 14.2 Type 1 Diabetes – Pediatric Patients
- 14.3 Type 1 Diabetes – Adults Continuous Subcutaneous Insulin Infusion
- 14.4 Type 1 Diabetes – Pediatric Continuous Subcutaneous Insulin Infusion
- 14.5 Type 2 Diabetes – Adults

## **16 HOW SUPPLIED/STORAGE AND HANDLING**

## **17 PATIENT COUNSELING INFORMATION**

\* Sections or subsections omitted from the full prescribing information are not listed.

---

## **FULL PRESCRIBING INFORMATION**

### **1 INDICATIONS AND USAGE**

HUMALOG is indicated to improve glycemic control in adult and pediatric patients with diabetes mellitus.

### **2 DOSAGE AND ADMINISTRATION**

## 2.1 Important Administration Instructions

- Always check insulin labels before administration [*see Warnings and Precautions (5.4)*].
- Inspect HUMALOG visually before use. It should appear clear and colorless. Do not use HUMALOG if particulate matter or coloration is seen.
- Use HUMALOG prefilled pens with caution in patients with visual impairment that may rely on audible clicks to dial their dose.
- Do NOT mix HUMALOG U-100 with other insulins when using a continuous subcutaneous infusion pump.
- Do NOT transfer HUMALOG U-200 from the prefilled pen to a syringe for administration [*see Warnings and Precautions (5.4)*].
- Do NOT perform dose conversion when using any HUMALOG U-100 or U-200 prefilled pens. The dose window shows the number of insulin units to be delivered and no conversion is needed.

## 2.2 Administration Instructions for the Approved Routes of Administration

### Subcutaneous Injection: HUMALOG U-100 or U-200

- Administer the dose of HUMALOG U-100 or HUMALOG U-200 within fifteen minutes before a meal or immediately after a meal by injection into the subcutaneous tissue of the abdominal wall, thigh, upper arm, or buttocks.
- Rotate the injection site within the same region from one injection to the next (abdominal wall, thigh, upper arm, or buttocks) to reduce the risk of lipodystrophy and localized cutaneous amyloidosis. Do not inject into areas of lipodystrophy or localized cutaneous amyloidosis [*see Warnings and Precautions (5.2) and Adverse Reactions (6)*].
- During changes to a patient's insulin regimen, increase the frequency of blood glucose monitoring [*see Warnings and Precautions (5.2)*].
- HUMALOG administered by subcutaneous injection should generally be used in regimens with an intermediate- or long-acting insulin.
- The HUMALOG U-100 KwikPen, HUMALOG U-100 Tempo Pen and HUMALOG U-200 KwikPen each dial in 1 unit increments and delivers a maximum dose of 60 units per injection.
- The HUMALOG U-100 Junior KwikPen dials in 0.5 unit increments and delivers a maximum dose of 30 units per injection.

### Subcutaneous Injection: Diluted HUMALOG U-100

- HUMALOG U-100 may be diluted with Sterile Diluent for HUMALOG for subcutaneous injection ONLY under medical supervision. Dilute one part HUMALOG U-100 to:
  - Nine parts diluent to yield a concentration one-tenth that of HUMALOG U-100 (equivalent to U-10).
  - One part diluent to yield a concentration one-half that of HUMALOG U-100 (equivalent to U-50).
- Diluted HUMALOG for subcutaneous injection may be stored for 28 days when refrigerated at 41°F (5°C) and for 14 days at room temperature up to 80°F (30°C).

### Continuous Subcutaneous Infusion (Insulin Pump): HUMALOG U-100 ONLY

- Do NOT administer HUMALOG U-200 using a continuous subcutaneous infusion pump.
- Refer to the continuous subcutaneous insulin infusion pump user manual to see if

HUMALOG can be used with the insulin pump. Use HUMALOG in accordance with the insulin pump system's instructions for use.

- Administer HUMALOG U-100 by continuous subcutaneous infusion in a region recommended in the instructions from the pump manufacturer. Rotate infusion sites within the same region to reduce the risk of lipodystrophy and localized cutaneous amyloidosis. Do not inject into areas of lipodystrophy or localized cutaneous amyloidosis [see *Warnings and Precautions (5.2) and Adverse Reactions (6)*].
- Train patients using continuous subcutaneous insulin infusion therapy to administer insulin by injection and have alternate insulin therapy available in case of insulin pump failure [see *Warnings and Precautions (5.8)*].
- During changes to a patient's insulin regimen, increase the frequency of blood glucose monitoring [see *Warnings and Precautions (5.2)*].
- Change HUMALOG U-100 in the pump reservoir at least every 7 days or according to the pump user manual, whichever is shorter.
- Change the infusion set and the infusion set insertion site according to the manufacturer's user manual.
- Do NOT dilute or mix HUMALOG U-100 when administering by continuous subcutaneous infusion.
- Do NOT expose HUMALOG U-100 in the pump reservoir to temperatures greater than 98.6°F (37°C).

#### Intravenous Administration: HUMALOG U-100 ONLY

- Do NOT administer HUMALOG U-200 intravenously.
- Administer HUMALOG U-100 intravenously ONLY under medical supervision with close monitoring of blood glucose and potassium levels to avoid hypoglycemia and hypokalemia [see *Warnings and Precautions (5.3, 5.6)*].
- Dilute HUMALOG U-100 to concentrations from 0.1 unit/mL to 1.0 unit/mL using 0.9% Sodium Chloride Injection, USP.
- Infusion bags prepared with HUMALOG U-100 are stable when stored in a refrigerator (2° to 8°C [36° to 46°F]) for 48 hours and then may be used at room temperature for up to an additional 48 hours.

### **2.3 Dosage Recommendations**

- Individualize and adjust the dosage of HUMALOG based on route of administration, the individual's metabolic needs, blood glucose monitoring results and glycemic control goal.
- When switching from another insulin to HUMALOG, a different dosage of HUMALOG may be needed [see *Warnings and Precautions (5.2)*].
- Dosage modifications may be needed with changes in physical activity, changes in meal patterns (i.e., macronutrient content or timing of food intake), changes in renal or hepatic function or during acute illness [see *Warnings and Precautions (5.2, 5.3) and Use in Specific Populations (8.6, 8.7)*].
- Do NOT perform dose conversion when using any HUMALOG U-100 or U-200 prefilled pens. The dose window shows the number of insulin units to be delivered and no conversion is needed.

### **2.4 Dosage Modifications for Drug Interactions**

Dosage modification may be needed when HUMALOG is used concomitantly with certain drugs [see *Drug Interactions (7)*].

## 2.5 Instructions for Mixing with Other Insulins

The table below includes administration instructions regarding mixing HUMALOG U-100 and HUMALOG U-200 with other insulins.

<b>HUMALOG U-100 subcutaneous injection route</b>	<ul style="list-style-type: none"><li>• HUMALOG U-100 may be mixed with NPH insulin preparations <u>ONLY</u>.</li><li>• If HUMALOG U-100 is mixed with NPH insulin, HUMALOG U-100 should be drawn into the syringe first. Injection should occur immediately after mixing.</li></ul>
<b>HUMALOG U-100 continuous subcutaneous infusion route (Insulin Pump)</b>	<u>Do NOT mix</u> HUMALOG U-100 with any other insulin.
<b>HUMALOG U-200 subcutaneous injection route</b>	<u>Do NOT mix</u> with any other insulin.

## 3 DOSAGE FORMS AND STRENGTHS

Injection: 100 units/mL (U-100) clear and colorless solution available as:

- 10 mL multiple-dose vial
- 3 mL multiple-dose vial
- 3 mL single-patient-use KwikPen prefilled pen
- 3 mL single-patient-use Tempo Pen prefilled pen
- 3 mL single-patient-use Junior KwikPen prefilled pen
- 3 mL single-patient-use cartridges

Injection: 200 units/mL (U-200) clear and colorless solution available as:

- 3 mL single-patient-use KwikPen prefilled pen

## 4 CONTRAINDICATIONS

HUMALOG is contraindicated:

- during episodes of hypoglycemia [*see Warnings and Precautions (5.3)*].
- in patients who are hypersensitive to insulin lispro or to any of the excipients in HUMALOG [*see Warnings and Precautions (5.5)*].

## 5 WARNINGS AND PRECAUTIONS

### 5.1 Never Share a HUMALOG Prefilled Pen, Cartridge, Reusable Pen Compatible with Lilly 3 mL Cartridges<sup>1</sup>, or Syringe Between Patients

HUMALOG prefilled pens, cartridges, and reusable pens compatible with Lilly 3 mL cartridges must never be shared between patients, even if the needle is changed. Patients using HUMALOG vials must never share needles or syringes with another person. Sharing poses a risk for transmission of blood-borne pathogens.

## 5.2 Hyperglycemia or Hypoglycemia with Changes in Insulin Regimen

Changes in an insulin regimen (e.g., insulin strength, manufacturer, type, injection site or method of administration) may affect glycemic control and predispose to hypoglycemia [see *Warnings and Precautions (5.3)*] or hyperglycemia. Repeated insulin injections into areas of lipodystrophy or localized cutaneous amyloidosis have been reported to result in hyperglycemia; and a sudden change in the injection site (to an unaffected area) has been reported to result in hypoglycemia [see *Adverse Reactions (6)*].

Make any changes to a patient's insulin regimen under close medical supervision with increased frequency of blood glucose monitoring. Advise patients who have repeatedly injected into areas of lipodystrophy or localized cutaneous amyloidosis to change the injection site to unaffected areas and closely monitor for hypoglycemia. For patients with type 2 diabetes, dosage adjustments of concomitant antidiabetic products may be needed.

## 5.3 Hypoglycemia

Hypoglycemia is the most common adverse reaction associated with insulins, including HUMALOG. Severe hypoglycemia can cause seizures, may be life-threatening, or cause death. Hypoglycemia can impair concentration ability and reaction time; this may place an individual and others at risk in situations where these abilities are important (e.g., driving or operating other machinery).

Hypoglycemia can happen suddenly, and symptoms may differ in each individual and change over time in the same individual. Symptomatic awareness of hypoglycemia may be less pronounced in patients with longstanding diabetes, in patients with diabetic nerve disease, in patients using medications that block the sympathetic nervous system (e.g., beta-blockers) [see *Drug Interactions (7)*], or in patients who experience recurrent hypoglycemia.

### Risk Factors for Hypoglycemia

The risk of hypoglycemia after an injection is related to the duration of action of the insulin and, in general, is highest when the glucose lowering effect of the insulin is maximal. As with all insulins, the glucose lowering effect time course of HUMALOG may vary in different individuals or at different times in the same individual and depends on many conditions, including the area of injection as well as the injection site blood supply and temperature [see *Clinical Pharmacology (12.2)*]. Other factors which may increase the risk of hypoglycemia include changes in meal pattern (e.g., macronutrient content or timing of meals), changes in level of physical activity, or changes to co-administered medication [see *Drug Interactions (7)*]. Patients with renal or hepatic impairment may be at higher risk of hypoglycemia [see *Use in Specific Populations (8.6, 8.7)*].

### Risk Mitigation Strategies for Hypoglycemia

Patients and caregivers must be educated to recognize and manage hypoglycemia. Self-monitoring of blood glucose plays an essential role in the prevention and management of hypoglycemia. In patients at higher risk for hypoglycemia and patients who have reduced symptomatic awareness of hypoglycemia, increased frequency of blood glucose monitoring is recommended.

## 5.4 Hypoglycemia Due to Medication Errors

Accidental mix-ups between insulin products have been reported. To avoid medication errors between HUMALOG and other insulins, instruct patients to always check the insulin label before each injection.

Do not transfer HUMALOG U-200 from the HUMALOG KwikPen to a syringe. The markings on the insulin syringe will not measure the dose correctly and can result in overdosage and severe hypoglycemia [see *Dosage and Administration (2.1)* and *Warnings and Precautions (5.3)*].

## **5.5 Hypersensitivity Reactions**

Severe, life-threatening, generalized allergy, including anaphylaxis, can occur with insulins, including HUMALOG. If hypersensitivity reactions occur, discontinue HUMALOG; treat per standard of care and monitor until symptoms and signs resolve [see *Adverse Reactions (6.1)*]. HUMALOG is contraindicated in patients who have had hypersensitivity reactions to insulin lispro or any of the excipients in HUMALOG [see *Contraindications (4)*].

## **5.6 Hypokalemia**

All insulins, including HUMALOG, cause a shift in potassium from the extracellular to intracellular space, possibly leading to hypokalemia. Untreated hypokalemia may cause respiratory paralysis, ventricular arrhythmia, and death. Monitor potassium levels in patients at risk for hypokalemia if indicated (e.g., patients using potassium-lowering medications, patients taking medications sensitive to serum potassium concentrations).

## **5.7 Fluid Retention and Heart Failure with Concomitant Use of PPAR-gamma Agonists**

Thiazolidinediones (TZDs), which are peroxisome proliferator-activated receptor (PPAR)-gamma agonists, can cause dose-related fluid retention, particularly when used in combination with insulin. Fluid retention may lead to or exacerbate heart failure. Patients treated with insulin, including HUMALOG, and a PPAR-gamma agonist should be observed for signs and symptoms of heart failure. If heart failure develops, it should be managed according to current standards of care, and discontinuation or dose reduction of the PPAR-gamma agonist must be considered.

## **5.8 Hyperglycemia and Ketoacidosis Due to Insulin Pump Device Malfunction**

Malfunction of the insulin pump or insulin infusion set or insulin degradation can rapidly lead to hyperglycemia and ketoacidosis. Prompt identification and correction of the cause of hyperglycemia or ketosis is necessary. Interim subcutaneous injections with HUMALOG may be required. Patients using continuous subcutaneous insulin infusion pump therapy must be trained to administer insulin by injection and have alternate insulin therapy available in case of pump failure [see *How Supplied/Storage and Handling (16.2)* and *Patient Counseling Information (17)*].

## **6 ADVERSE REACTIONS**

The following adverse reactions are discussed elsewhere:

- Hypoglycemia [see *Warnings and Precautions (5.3)*].
- Hypoglycemia Due to Medication Errors [see *Warnings and Precautions (5.4)*].



- Hypersensitivity Reactions [see Warnings and Precautions (5.5)].
- Hypokalemia [see Warnings and Precautions (5.6)].

## 6.1 Clinical Trials Experience

Because clinical trials are conducted under widely varying designs, the adverse reaction rates reported in one clinical trial may not be easily compared with those rates reported in another clinical trial, and may not reflect the rates actually observed in clinical practice.

Common adverse reactions, excluding hypoglycemia, were defined as events that occurred in  $\geq 5\%$  of patients treated with insulin lispro or regular human insulin. The frequencies of adverse reactions during HUMALOG clinical trials in patients with type 1 diabetes mellitus and type 2 diabetes mellitus are listed in the tables below.

**Table 1: Adverse Reactions That Occurred in  $\geq 5\%$  in Patients with Type 1 Diabetes Mellitus**

	<b>HUMALOG (%) (n=81)</b>	<b>Regular human insulin (%) (n=86)</b>
Flu syndrome	34.6	32.6
Pharyngitis	33.3	33.7
Rhinitis	24.7	29.1
Headache	29.6	22.1
Pain	19.8	16.3
Cough increased	17.3	17.4
Infection	13.6	20.9
Nausea	6.2	15.1
Accidental injury	8.6	11.6
Surgical procedure	6.2	14.0
Fever	6.2	11.6
Abdominal pain	7.4	8.1
Asthenia	7.4	8.1
Bronchitis	7.4	7.0
Diarrhea	8.6	5.8
Dysmenorrhea	6.2	7.0
Myalgia	7.4	5.8
Urinary tract infection	6.2	4.7

**Table 2: Adverse Reactions That Occurred in  $\geq 5\%$  in Patients with Type 2 Diabetes Mellitus**

	<b>HUMALOG (%) (n=714)</b>	<b>Regular human insulin (%) (n=709)</b>
Headache	11.6	9.3
Pain	10.8	10.0
Infection	10.1	7.6
Pharyngitis	6.6	8.2
Rhinitis	8.1	6.6

Flu syndrome	6.2	8.2
Surgical procedure	7.4	6.8

### Insulin initiation and intensification of glucose control

Intensification or rapid improvement in glucose control has been associated with a transitory, reversible ophthalmologic refraction disorder, worsening of diabetic retinopathy, and acute painful peripheral neuropathy. However, long-term glycemic control decreases the risk of diabetic retinopathy and neuropathy.

### Hypoglycemia

Hypoglycemia is the most commonly observed adverse reaction in patients using insulin, including HUMALOG.

### Lipodystrophy

Long-term use of insulin, including HUMALOG, can cause lipodystrophy at the site of repeated insulin injections or infusion. Lipodystrophy includes lipohypertrophy (thickening of adipose tissue) and lipoatrophy (thinning of adipose tissue), and may affect insulin absorption [see *Dosage and Administration (2.2)*].

### Weight gain

Weight gain can occur with insulins, including HUMALOG, and has been attributed to the anabolic effects of insulin and the decrease in glucosuria.

### Peripheral Edema

Insulins, including HUMALOG, may cause sodium retention and edema, particularly if previously poor metabolic control is improved by intensified insulin therapy.

### Adverse Reactions with Continuous Subcutaneous Insulin Infusion (CSII) — HUMALOG U-100

In a 12-week, randomized, crossover study in adult patients with type 1 diabetes (n=39), the rates of catheter occlusions and infusion site reactions were similar for HUMALOG U-100 and regular human insulin treated patients (see Table 3).

**Table 3: Catheter Occlusions and Infusion Site Reactions**

	HUMALOG U-100 (n=38)	Regular human insulin (n=39)
Catheter occlusions/month	0.09	0.10
Infusion site reactions	2.6% (1/38)	2.6% (1/39)

In a randomized, 16-week, open-label, parallel design study of pediatric patients with type 1 diabetes, adverse reactions related to infusion-site reactions were similar for insulin lispro and insulin aspart (21% of 100 patients versus 17% of 198 patients, respectively). In both groups, the most frequently reported infusion site reactions were infusion site erythema and infusion site reaction.

### Allergic Reactions

*Local Allergy* — As with any insulin, patients taking HUMALOG may experience redness,

swelling, or itching at the site of the injection. These minor reactions usually resolve in a few days to a few weeks, but in some occasions, may require discontinuation of HUMALOG.

*Systemic Allergy* — Severe, life-threatening, generalized allergy, including anaphylaxis, may occur with any insulin, including HUMALOG. Generalized allergy to insulin may cause whole body rash (including pruritus), dyspnea, wheezing, hypotension, tachycardia, or diaphoresis.

In controlled clinical trials, pruritus (with or without rash) was seen in 17 patients receiving regular human insulin (n=2969) and 30 patients receiving HUMALOG (n=2944).

Localized reactions and generalized myalgias have been reported with injected metacresol, which is an excipient in HUMALOG [see *Contraindications (4)*].

### Antibody Production

In large clinical trials with patients with type 1 (n=509) and type 2 (n=262) diabetes mellitus, anti-insulin antibody (insulin lispro-specific antibodies, insulin-specific antibodies, cross-reactive antibodies) formation was evaluated in patients receiving both regular human insulin and HUMALOG (including patients previously treated with human insulin and naive patients). As expected, the largest increase in the antibody levels occurred in patients new to insulin therapy. The antibody levels peaked by 12 months and declined over the remaining years of the study. These antibodies do not appear to cause deterioration in glycemic control or necessitate an increase in insulin dose. There was no statistically significant relationship between the change in the total daily insulin dose and the change in percent antibody binding for any of the antibody types.

## **6.2 Postmarketing Experience**

The following additional adverse reactions have been identified during post-approval use of HUMALOG. Because these reactions are reported voluntarily from a population of uncertain size, it is not always possible to reliably estimate their frequency or establish a causal relationship to drug exposure.

Medication errors in which other insulins have been accidentally substituted for HUMALOG have been identified during post-approval use.

Localized cutaneous amyloidosis at the injection site has occurred. Hyperglycemia has been reported with repeated insulin injections into areas of localized cutaneous amyloidosis; hypoglycemia has been reported with a sudden change to an unaffected injection site.

## **7 DRUG INTERACTIONS**

The table below includes clinically significant drug interactions with HUMALOG.

<b>Drugs That May Increase the Risk of Hypoglycemia</b>	
<i>Drugs:</i>	Antidiabetic agents, ACE inhibitors, angiotensin II receptor blocking agents, disopyramide, fibrates, fluoxetine, monoamine oxidase inhibitors, pentoxifylline, pramlintide, salicylates, somatostatin analog (e.g., octreotide), and sulfonamide antibiotics.

<i>Intervention:</i>	Dose adjustment and increased frequency of glucose monitoring may be required when HUMALOG is co-administered with these drugs.
<b>Drugs That May Decrease the Blood Glucose Lowering Effect of HUMALOG</b>	
<i>Drugs:</i>	Atypical antipsychotics (e.g., olanzapine and clozapine), corticosteroids, danazol, diuretics, estrogens, glucagon, isoniazid, niacin, oral contraceptives, phenothiazines, progestogens (e.g., in oral contraceptives), protease inhibitors, somatropin, sympathomimetic agents (e.g., albuterol, epinephrine, terbutaline), and thyroid hormones.
<i>Intervention:</i>	Dose adjustment and increased frequency of glucose monitoring may be required when HUMALOG is co-administered with these drugs.
<b>Drugs That May Increase or Decrease the Blood Glucose Lowering Effect of HUMALOG</b>	
<i>Drugs:</i>	Alcohol, beta-blockers, clonidine, and lithium salts. Pentamidine may cause hypoglycemia, which may sometimes be followed by hyperglycemia.
<i>Intervention:</i>	Dose adjustment and increased frequency of glucose monitoring may be required when HUMALOG is co-administered with these drugs.
<b>Drugs That May Blunt Signs and Symptoms of Hypoglycemia</b>	
<i>Drugs:</i>	Beta-blockers, clonidine, guanethidine and reserpine.
<i>Intervention:</i>	Increased frequency of glucose monitoring may be required when HUMALOG is co-administered with these drugs.

## 8 USE IN SPECIFIC POPULATIONS

### 8.1 Pregnancy

#### Risk Summary

Published studies with insulin lispro used during pregnancy have not reported an association between insulin lispro and the induction of major birth defects, miscarriage, or adverse maternal or fetal outcomes (*see Data*). There are risks to the mother and fetus associated with poorly controlled diabetes in pregnancy (*see Clinical Considerations*).

Pregnant rats and rabbits were exposed to insulin lispro in animal reproduction studies during organogenesis. No adverse effects on embryo/fetal viability or morphology were observed in offspring of rats exposed to insulin lispro at a dose approximately 3 times the human subcutaneous dose of 1 unit insulin lispro/kg/day. No adverse effects on embryo/fetal development were observed in offspring of rabbits exposed to insulin lispro at doses up to approximately 0.2 times the human subcutaneous dose of 1 unit/kg/day (*see Data*).

The estimated background risk of major birth defects is 6-10% in women with pre-gestational diabetes with a HbA1c >7 and has been reported to be as high as 20-25% in women with a HbA1c >10. The estimated background risk of miscarriage for the indicated population is unknown. In the U.S. general population, the estimated background risk of major birth defects and miscarriage in clinically recognized pregnancies is 2-4% and 15-20%, respectively.

#### Clinical Considerations

---

### *Disease-associated maternal and/or embryo/fetal risk*

Poorly controlled diabetes in pregnancy increases the maternal risk for diabetic ketoacidosis, pre-eclampsia, spontaneous abortions, preterm delivery, and delivery complications. Poorly controlled diabetes increases the fetal risk for major birth defects, stillbirth, and macrosomia related morbidity.

### Data

#### *Human Data*

Published data from retrospective studies and meta-analyses do not report an association with insulin lispro and major birth defects, miscarriage, or adverse maternal or fetal outcomes when insulin lispro is used during pregnancy. However, these studies cannot definitely establish or exclude the absence of any risk because of methodological limitations including small sample size, selection bias, confounding by unmeasured factors, and some lacking comparator groups.

#### *Animal Data*

In a combined fertility and embryo-fetal development study, female rats were given subcutaneous insulin lispro injections of 1, 5, and 20 units/kg/day (0.2, 0.8, and 3 times the human subcutaneous dose of 1 unit insulin lispro/kg/day, based on units/body surface area, respectively) from 2 weeks prior to cohabitation through Gestation Day 19. There were no adverse effects on female fertility, implantation, or fetal viability and morphology. However, fetal growth retardation was produced at the 20 units/kg/day-dose as indicated by decreased fetal weight and an increased incidence of fetal runts/litter.

In an embryo-fetal development study in pregnant rabbits, insulin lispro doses of 0.1, 0.25, and 0.75 unit/kg/day (0.03, 0.08, and 0.2 times the human subcutaneous dose of 1 unit insulin lispro/kg/day, based on units/body surface area, respectively) were injected subcutaneously on Gestation days 7 through 19. There were no adverse effects on fetal viability, weight, and morphology at any dose.

## **8.2 Lactation**

### Risk Summary

Available data from published literature suggests that exogenous human insulin products, including insulin lispro, are transferred into human milk. There are no adverse reactions reported in breastfed infants in the literature. There are no data on the effects of exogenous human insulin products, including insulin lispro, on milk production. The developmental and health benefits of breastfeeding should be considered along with the mother's clinical need for insulin, any potential adverse effects on the breastfed child from HUMALOG or from the underlying maternal condition.

## **8.4 Pediatric Use**

The safety and effectiveness of HUMALOG to improve glycemic control have been established in pediatric patients with diabetes mellitus. Use of HUMALOG for this indication is supported by evidence from adequate and well-controlled studies in 831 pediatric patients with type 1 diabetes mellitus aged 3 years and older and from studies in adults with diabetes mellitus [*see Adverse Reactions (6.1), Clinical Pharmacology*

(12.3), and Clinical Studies (14)].

## 8.5 Geriatric Use

Of the total number of patients (n=2,834) in eight clinical studies of HUMALOG, twelve percent (n=338) were 65 years of age or over. The majority of these patients had type 2 diabetes. HbA<sub>1c</sub> values and hypoglycemia rates did not differ by age.

Pharmacokinetic/pharmacodynamic studies to assess the effect of age on the onset of HUMALOG action have not been performed.

## 8.6 Renal Impairment

Patients with renal impairment may be at increased risk of hypoglycemia and may require more frequent HUMALOG dose adjustment and more frequent blood glucose monitoring [see Clinical Pharmacology (12.3)].

## 8.7 Hepatic Impairment

Patients with hepatic impairment may be at increased risk of hypoglycemia and may require more frequent HUMALOG dose adjustment and more frequent blood glucose monitoring [see Clinical Pharmacology (12.3)].

## 10 OVERDOSAGE

Excess insulin administration may cause hypoglycemia and hypokalemia. Mild episodes of hypoglycemia usually can be treated with oral glucose. Adjustments in drug dosage, meal patterns, or exercise may be needed. More severe episodes with coma, seizure, or neurologic impairment may be treated with a glucagon product for emergency use or concentrated intravenous glucose. Sustained carbohydrate intake and observation may be necessary because hypoglycemia may recur after apparent clinical recovery. Hypokalemia must be corrected appropriately.

## 11 DESCRIPTION

Insulin lispro is a rapid-acting human insulin analog produced by recombinant DNA technology utilizing a non-pathogenic laboratory strain of *Escherichia coli*. Insulin lispro differs from human insulin in that the amino acid proline at position B28 is replaced by lysine and the lysine in position B29 is replaced by proline. Chemically, it is Lys(B28), Pro(B29) human insulin analog and has the empirical formula C<sub>257</sub>H<sub>383</sub>N<sub>65</sub>O<sub>77</sub>S<sub>6</sub> and a molecular weight of 5.808 kDa, both identical to that of human insulin.

Insulin lispro has the following primary structure:

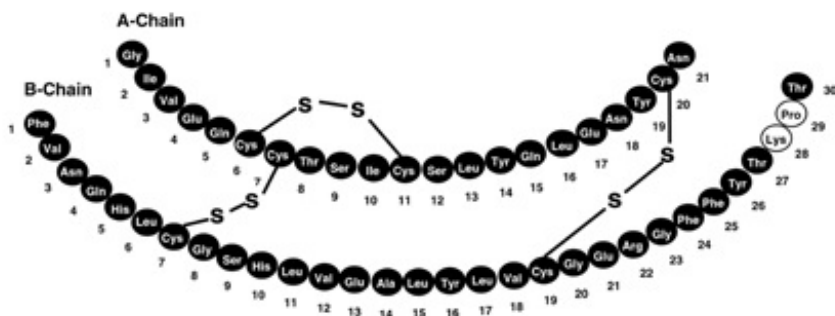

HUMALOG (insulin lispro) injection is a sterile, clear, and colorless solution for subcutaneous or intravenous use.

Each mL of HUMALOG U-100 contains 100 units of insulin lispro, and the inactive ingredients: dibasic sodium phosphate (1.0 mg), glycerin (16 mg), metacresol (3.15 mg), trace amounts of phenol, zinc oxide (content adjusted to provide 0.0197 mg zinc ion), and Water for Injection, USP.

Each mL of HUMALOG U-200 contains 200 units of insulin lispro, and the inactive ingredients: glycerin (16 mg), metacresol (3.15 mg), trace amounts of phenol, tromethamine (5 mg), zinc oxide (content adjusted to provide 0.046 mg zinc ion), and Water for Injection, USP.

HUMALOG has a pH of 7.0 to 7.8.

Hydrochloric acid 10% and/or sodium hydroxide 10% is added to adjust the pH.

## 12 CLINICAL PHARMACOLOGY

### 12.1 Mechanism of Action

Regulation of glucose metabolism is the primary activity of insulins and insulin analogs, including insulin lispro. Insulins lower blood glucose by stimulating peripheral glucose uptake by skeletal muscle and fat, and by inhibiting hepatic glucose production. Insulins inhibit lipolysis and proteolysis, and enhance protein synthesis.

### 12.2 Pharmacodynamics

HUMALOG has been shown to be equipotent to human insulin on a molar basis. One unit of HUMALOG has the same glucose-lowering effect as one unit of regular human insulin. Studies in normal volunteers and patients with diabetes demonstrated that HUMALOG has a more rapid onset of action and a shorter duration of activity than regular human insulin when given subcutaneously.

The time course of action of insulin and insulin analogs, such as HUMALOG, may vary considerably in different individuals or within the same individual. The parameters of HUMALOG activity (time of onset, peak time, and duration) as designated in Figure 1 should be considered only as general guidelines. The rate of insulin absorption, and consequently the onset of activity are known to be affected by the site of injection, exercise, and other variables [see *Warnings and Precautions (5.2)*].

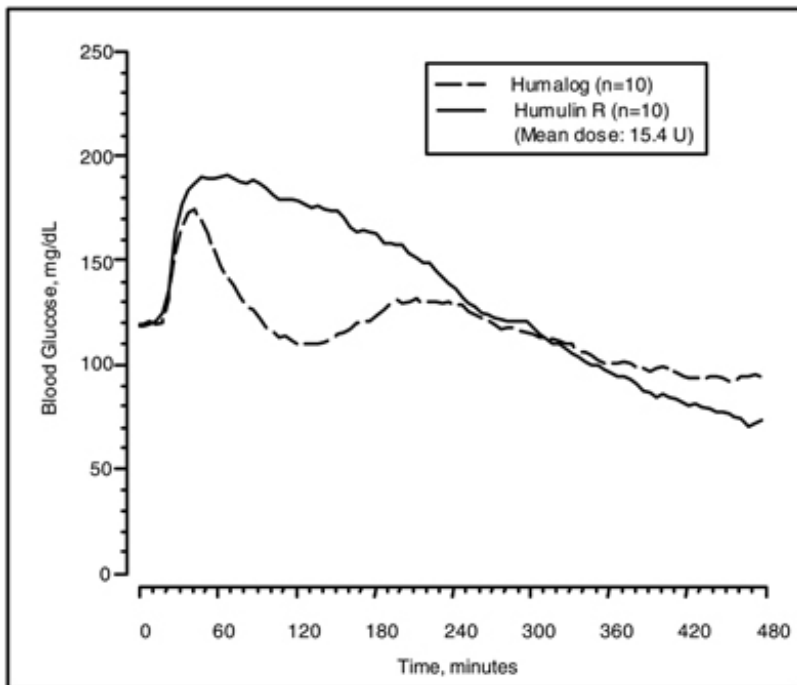

**Figure 1: Blood Glucose Levels After Subcutaneous Injection of Regular Human Insulin or HUMALOG (0.2 unit/kg) Immediately Before a High Carbohydrate Meal in 10 Patients with Type 1 Diabetes<sup>a</sup>.**

<sup>a</sup> Baseline insulin concentration was maintained by infusion of 0.2 mU/min/kg human insulin.

Intravenous Administration of HUMALOG U-100 — The glucose lowering effect of intravenously administered HUMALOG was tested in 21 patients with type 1 diabetes. For the study, the patients' usual doses of insulin were held and blood glucose concentrations were allowed to reach a stable range of 200 to 260 mg/dL during a one to three hours run-in phase. The run-in phase was followed by a 6-hour assessment phase. During the assessment phase, patients received intravenous HUMALOG at an initial infusion rate of 0.5 units/hour. The infusion rate of HUMALOG could be adjusted at regular timed intervals to achieve and maintain blood glucose concentrations between 100 to 160 mg/dL.

The mean blood glucose levels during the assessment phase for patients on HUMALOG therapy are summarized below in Table 4. All patients achieved the targeted glucose range at some point during the 6-hour assessment phase. At the endpoint, blood glucose was within the target range (100 to 160 mg/dL) for 17 of 20 patients treated with HUMALOG. The average time ( $\pm$ SE) required to attain near normoglycemia was  $129 \pm 14$  minutes for HUMALOG.

**Table 4: Mean Blood Glucose Concentrations (mg/dL) During Intravenous Infusions of HUMALOG U-100**

Time from Start of Infusion (minutes)	Mean Blood Glucose (mg/dL) Intravenous <sup>a</sup>
0	224 $\pm$ 16
30	205 $\pm$ 21
60	195 $\pm$ 20
120	165 $\pm$ 26



180	140 ± 26
240	123 ± 20
300	120 ± 27
360	122 ± 25

<sup>a</sup> Results shown as mean ± SD

The pharmacodynamics of a single 20 unit dose of HUMALOG U-200 administered subcutaneously were compared to the pharmacodynamics of a single 20 unit dose of HUMALOG U-100 administered subcutaneously in a euglycemic clamp study enrolling healthy subjects. In this study, the overall, maximum, and time to maximum glucose lowering effect were similar between HUMALOG U-200 and HUMALOG U-100. The mean area under the glucose infusion rate curves (measure of overall pharmacodynamic effect) were 125 g and 126 g for HUMALOG U-200 and HUMALOG U-100, respectively. The maximum glucose infusion rate was 534 mg/min and 559 mg/min and the corresponding median time (min, max) to maximum effect were 2.8 h (0.5 h - 6.3 h) and 2.4 h (0.5 h - 4.7 h) for HUMALOG U-200 and HUMALOG U-100, respectively.

### 12.3 Pharmacokinetics

Absorption and Bioavailability — Studies in healthy volunteers and patients with diabetes demonstrated that HUMALOG is absorbed more quickly than regular human insulin. In healthy volunteers given subcutaneous doses of HUMALOG ranging from 0.1 to 0.4 unit/kg, peak serum levels were seen 30 to 90 minutes after dosing. When healthy volunteers received equivalent doses of regular human insulin, peak insulin levels occurred between 50 to 120 minutes after dosing. Similar results were seen in patients with type 1 diabetes (see Figure 2).

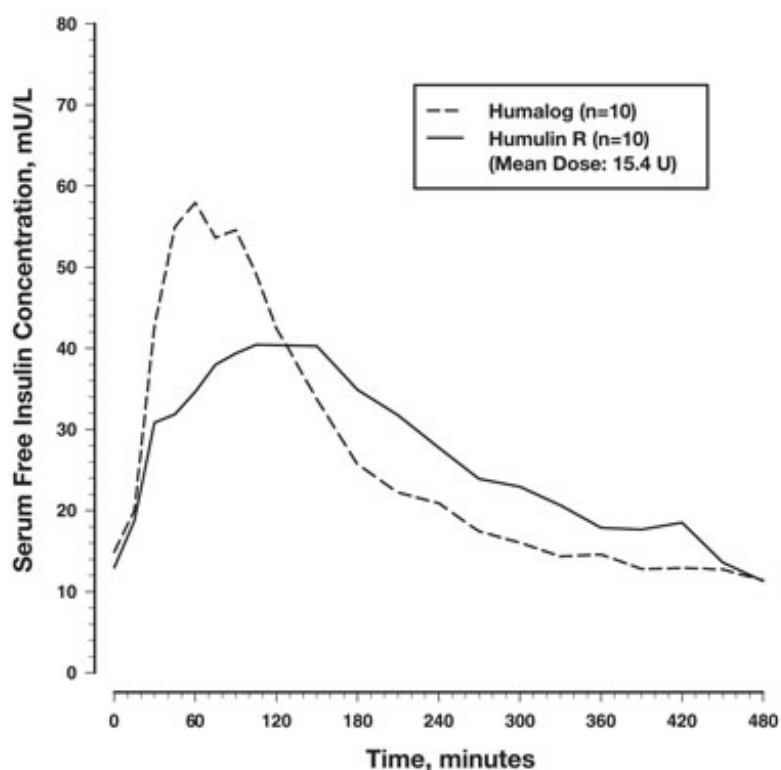

**Figure 2: Serum HUMALOG and Insulin Levels After Subcutaneous Injection of Regular**

## **Human Insulin or HUMALOG (0.2 unit/kg) Immediately Before a High Carbohydrate Meal in 10 Patients with Type 1 Diabetes<sup>a</sup>.**

<sup>a</sup> Baseline insulin concentration was maintained by infusion of 0.2 mU/min/kg human insulin.

HUMALOG U-100 was absorbed at a consistently faster rate than regular human insulin in healthy male volunteers given 0.2 unit/kg at abdominal, deltoid, or femoral subcutaneous sites. After HUMALOG was administered in the abdomen, serum drug levels were higher and the duration of action was slightly shorter than after deltoid or thigh administration. Bioavailability of HUMALOG is similar to that of regular human insulin. The absolute bioavailability after subcutaneous injection ranges from 55% to 77% with doses between 0.1 to 0.2 unit/kg, inclusive.

The results of a study in healthy subjects demonstrated that HUMALOG U-200 is bioequivalent to HUMALOG U-100 following administration of a single 20 unit dose.

The mean observed area under the serum insulin concentration-time curve from time zero to infinity was 2360 pmol hr/L and 2390 pmol hr/L for HUMALOG U-200 and HUMALOG U-100, respectively. The corresponding mean peak serum insulin concentration was 795 pmol/L and 909 pmol/L for HUMALOG U-200 and HUMALOG U-100, respectively. The median time to maximum concentration was 1.0 hour for both formulations.

Distribution — When administered intravenously as bolus injections of 0.1 and 0.2 U/kg dose in two separate groups of healthy subjects, the mean volume of distribution of HUMALOG appeared to decrease with increase in dose (1.55 and 0.72 L/kg, respectively) in contrast to that of regular human insulin for which, the volume of distribution was comparable across the two dose groups (1.37 and 1.12 L/kg for 0.1 and 0.2 U/kg dose, respectively).

Metabolism — Human metabolism studies have not been conducted. However, animal studies indicate that the metabolism of HUMALOG is identical to that of regular human insulin.

Elimination — After subcutaneous administration of HUMALOG, the  $t_{1/2}$  is shorter than that of regular human insulin (1 versus 1.5 hours, respectively). When administered intravenously, HUMALOG and regular human insulin demonstrated similar dose-dependent clearance, with a mean clearance of 21.0 mL/min/kg and 21.4 mL/min/kg, respectively (0.1 unit/kg dose), and 9.6 mL/min/kg and 9.4 mL/min/kg, respectively (0.2 unit/kg dose). Accordingly, HUMALOG demonstrated a mean  $t_{1/2}$  of 0.85 hours (51 minutes) and 0.92 hours (55 minutes), respectively for 0.1 unit/kg and 0.2 unit/kg doses, and regular human insulin mean  $t_{1/2}$  was 0.79 hours (47 minutes) and 1.28 hours (77 minutes), respectively for 0.1 unit/kg and 0.2 unit/kg doses.

### Specific Populations

The effects of age, gender, race, obesity, pregnancy, or smoking on the pharmacokinetics of HUMALOG have not been studied.

*Renal Impairment* — Type 2 diabetic patients with varying degree of renal impairment showed no difference in pharmacokinetics of regular insulin and HUMALOG. However, the sensitivity of the patients to insulin did change, with an increased response to insulin as the renal function declined. Some studies with human insulin have shown increased

circulating levels of insulin in patients with renal impairment [see *Use in Specific Populations* (8.6)].

*Hepatic Impairment* — Type 2 diabetic patients with impaired hepatic function showed no effect on the pharmacokinetics of HUMALOG as compared to patients with no hepatic dysfunction. However, some studies with human insulin have shown increased circulating levels of insulin in patients with liver failure [see *Use in Specific Populations* (8.7)].

## **13 NONCLINICAL TOXICOLOGY**

### **13.1 Carcinogenesis, Mutagenesis, Impairment of Fertility**

Standard 2-year carcinogenicity studies in animals have not been performed. In Fischer 344 rats, a 12-month repeat-dose toxicity study was conducted with insulin lispro at subcutaneous doses of 20 and 200 units/kg/day (approximately 3 and 32 times the human subcutaneous dose of 1 unit/kg/day, based on units/body surface area). Insulin lispro did not produce important target organ toxicity including mammary tumors at any dose.

Insulin lispro was not mutagenic in the following genetic toxicity assays: bacterial mutation, unscheduled DNA synthesis, mouse lymphoma, chromosomal aberration and micronucleus assays.

Male fertility was not compromised when male rats given subcutaneous insulin lispro injections of 5 and 20 units/kg/day (0.8 and 3 times the human subcutaneous dose of 1 unit/kg/day, based on units/body surface area) for 6 months were mated with untreated female rats. In a combined fertility, perinatal, and postnatal study in male and female rats given 1, 5, and 20 units/kg/day subcutaneously (0.2, 0.8, and 3 times the human subcutaneous dose of 1 unit/kg/day, based on units/body surface area), mating and fertility were not adversely affected in either gender at any dose.

### **13.2 Animal Toxicology and/or Pharmacology**

In standard biological assays in fasted rabbits, 0.2 unit/kg of insulin lispro injected subcutaneously had the same glucose-lowering effect and had a more rapid onset of action as 0.2 unit/kg of regular human insulin.

## **14 CLINICAL STUDIES**

The safety and efficacy of HUMALOG U-100 were studied in pediatric and adult patients with type 1 diabetes (n=789) and adult patients with type 2 diabetes (n=722).

### **14.1 Type 1 Diabetes - Adults and Pediatric Patients Aged 12 years and Older**

A 12-month, randomized, parallel, open-label, active-controlled study was conducted in patients with type 1 diabetes to assess the safety and efficacy of HUMALOG (n=81) compared with Humulin<sup>®</sup> R [insulin human injection (100 units/mL)] (n=86). HUMALOG was administered by subcutaneous injection immediately prior to meals and Humulin R was administered 30 to 45 minutes before meals. Humulin<sup>®</sup> U [ULTRALENTE<sup>®</sup> human insulin (rDNA origin) extended zinc suspension] was administered once or twice daily as

the basal insulin. There was a 2- to 4-week run-in period with Humulin R and Humulin U before randomization. Most patients were Caucasian (97%). Forty-seven percent of the patients were male. The mean age was 31 years (range 12 to 70 years). Glycemic control, the total daily doses of HUMALOG and Humulin R, and the incidence of severe hypoglycemia (as determined by the number of events that were not self-treated) were similar in the two treatment groups. There were no episodes of diabetic ketoacidosis in either treatment group.

**Table 5: Type 1 Diabetes Mellitus - Adults and Pediatric Patients Aged 12 years and Older**

Treatment Duration Treatment in Combination with:	12 months Humulin U	
	HUMALOG	Humulin R
N	81	86
Baseline HbA <sub>1c</sub> (%) <sup>a</sup>	8.2 ± 1.4	8.3 ± 1.7
Change from baseline HbA <sub>1c</sub> (%) <sup>a</sup>	-0.1 ± 0.9	0.1 ± 1.1
Treatment Difference in HbA <sub>1c</sub> Mean (95% confidence interval)	0.4 (0.0, 0.8)	
Baseline short-acting insulin dose (units/kg/day)	0.3 ± 0.1	0.3 ± 0.1
End-of-Study short-acting insulin dose (units/kg/day)	0.3 ± 0.1	0.3 ± 0.1
Change from baseline short-acting insulin dose (units/kg/day)	0.0 ± 0.1	0.0 ± 0.1
Baseline Body weight (kg)	72 ± 12.7	71 ± 11.3
Weight change from baseline (kg)	1.4 ± 3.6	1.0 ± 2.6
Patients with severe hypoglycemia (n, %) <sup>b</sup>	14 (17%)	18 (21%)

<sup>a</sup> Values are Mean ± SD

<sup>b</sup> Severe hypoglycemia refers to hypoglycemia for which patients were not able to self-treat.

## 14.2 Type 1 Diabetes - Pediatric Patients

An 8-month, crossover study of pediatric patients with type 1 diabetes (n=463), aged 9 to 19 years, compared two subcutaneous multiple-dose treatment regimens: HUMALOG or Humulin R, both administered with Humulin N (NPH human insulin) as the basal insulin. HUMALOG achieved glycemic control comparable to Humulin R, as measured by HbA<sub>1c</sub> (see Table 6), and both treatment groups had a comparable incidence of hypoglycemia. In a 9-month, crossover study of pediatric patients (n=60) with type 1 diabetes, aged 3 to 11 years, HUMALOG administered immediately before meals, HUMALOG administered immediately after meals and Humulin R administered 30 minutes before meals resulted in similar glycemic control, as measured by HbA<sub>1c</sub>, and incidence of hypoglycemia, regardless of treatment group.

**Table 6: Pediatric Subcutaneous Administration of HUMALOG in Type 1 Diabetes**

	Baseline	End point	
		HUMALOG +	Humulin R +

		NPH	NPH
HbA <sub>1c</sub> (%) <sup>a</sup>	8.6 ± 1.5	8.7 ± 1.5	8.7 ± 1.6
Change from baseline HbA <sub>1c</sub> (%) <sup>a</sup>	—	0.1 ± 1.1	0.1 ± 1.3
Short-acting insulin dose (units/kg/day) <sup>a</sup>	0.5 ± 0.2	0.5 ± 0.2	0.5 ± 0.2
Change from baseline short-acting insulin dose (units/kg/day) <sup>a</sup>	—	0.01 ± 0.1	-0.01 ± 0.1
Body weight (kg) <sup>a</sup>	59.1 ± 13.1	61.1 ± 12.7	61.4 ± 12.9
Weight change from baseline (kg) <sup>a</sup>	—	2.0 ± 3.1	2.3 ± 3.0
Patients with severe hypoglycemia (n, %) <sup>b</sup>	—	5 (1.1%)	5 (1.1%)
Diabetic ketoacidosis (n, %)	—	11 (2.4%)	9 (1.9%)

<sup>a</sup> Values are Mean ± SD

<sup>b</sup> Severe hypoglycemia refers to hypoglycemia that required glucagon or glucose injection or resulted in coma.

### 14.3 Type 1 Diabetes - Adults Continuous Subcutaneous Insulin Infusion

To evaluate the administration of HUMALOG U-100 via external insulin pumps, two open-label, crossover design studies were performed in patients with type 1 diabetes. One study involved 39 patients, ages 19 to 58 years, treated for 24 weeks with HUMALOG or regular human insulin. After 12 weeks of treatment, the mean HbA<sub>1c</sub> values decreased from 7.8% to 7.2% in the HUMALOG-treated patients and from 7.8% to 7.5% in the regular human insulin-treated patients. Another study involved 60 patients (mean age 39, range 15 to 58 years) treated for 24 weeks with either HUMALOG or buffered regular human insulin. After 12 weeks of treatment, the mean HbA<sub>1c</sub> values decreased from 7.7% to 7.4% in the HUMALOG-treated patients and remained unchanged from 7.7% in the buffered regular human insulin-treated patients. Rates of hypoglycemia were comparable between treatment groups in both studies.

### 14.4 Type 1 Diabetes - Pediatric Continuous Subcutaneous Insulin Infusion

A randomized, 16-week, open-label, parallel design, study of pediatric patients with type 1 diabetes (n=298) aged 4 to 18 years compared two subcutaneous infusion regimens administered via an external insulin pump: insulin aspart (n=198) or HUMALOG U-100 (n=100). These two treatments resulted in comparable changes from baseline in HbA<sub>1c</sub> and comparable rates of hypoglycemia after 16 weeks of treatment (see Table 7). Infusion site reactions were similar between groups.

**Table 7: Pediatric Insulin Pump Study in Type 1 Diabetes (16 weeks; n=298)**

	HUMALOG	Aspart
N	100	198
Baseline HbA <sub>1c</sub> (%) <sup>a</sup>	8.2 ± 0.8	8.0 ± 0.9
Change from Baseline HbA <sub>1c</sub> (%)	-0.1 ± 0.7	-0.1 ± 0.8
Treatment Difference in HbA <sub>1c</sub> , Mean (95% confidence interval)	0.1 (-0.3, 0.1)	
Baseline insulin dose (units/kg/24 hours) <sup>a</sup>	0.9 ± 0.3	0.9 ± 0.3
End-of-Study insulin dose (units/kg/24 hours) <sup>a</sup>	0.9 ± 0.2	0.9 ± 0.2
Patients with severe hypoglycemia (n, %) <sup>b</sup>	8 (8%)	19 (10%)

Diabetic ketoacidosis (n, %)	0 (0)	1 (0.5%)
Baseline body weight (kg) <sup>a</sup>	55.5 ± 19.0	54.1 ± 19.7
Weight Change from baseline (kg) <sup>a</sup>	1.6 ± 2.1	1.8 ± 2.1

<sup>a</sup> Values are Mean ± SD

<sup>b</sup> Severe hypoglycemia refers to hypoglycemia associated with central nervous system symptoms and requiring the intervention of another person or hospitalization.

## 14.5 Type 2 Diabetes - Adults

A 6-month randomized, crossover, open-label, active-controlled study was conducted in insulin-treated patients with type 2 diabetes (n=722) to assess the safety and efficacy of HUMALOG for 3 months followed by Humulin R for 3 months or the reverse sequence. HUMALOG was administered by subcutaneous injection immediately before meals and Humulin R was administered 30 to 45 minutes before meals. Humulin® N [NPH human insulin (rDNA origin) isophane suspension] or Humulin U was administered once or twice daily as the basal insulin. All patients participated in a 2- to 4-week run-in period with Humulin R and Humulin N or Humulin U. Most of the patients were Caucasian (88%), and the numbers of men and women in each group were approximately equal. The mean age was 58.6 years (range 23.8 to 85 years). The average body mass index (BMI) was 28.2 kg/m<sup>2</sup>. During the study, the majority of patients used Humulin N (84%) compared with Humulin U (16%) as their basal insulin. The reductions from baseline in HbA<sub>1c</sub> and the incidence of severe hypoglycemia (as determined by the number of events that were not self-treated) were similar between the two treatments from the combined groups (see Table 8).

**Table 8: Type 2 Diabetes Mellitus — Adults**

	Baseline	End point	
		HUMALOG + Basal	Humulin R + Basal
HbA <sub>1c</sub> (%) <sup>a</sup>	8.9 ± 1.7	8.2 ± 1.3	8.2 ± 1.4
Change from baseline HbA <sub>1c</sub> (%) <sup>a</sup>	—	-0.7 ± 1.4	-0.7 ± 1.3
Short-acting insulin dose (units/kg/day) <sup>a</sup>	0.3 ± 0.2	0.3 ± 0.2	0.3 ± 0.2
Change from baseline short-acting insulin dose (units/kg/day) <sup>a</sup>	—	0.0 ± 0.1	0.0 ± 0.1
Body weight (kg) <sup>a</sup>	80 ± 15	81 ± 15	81 ± 15
Weight change from baseline	—	0.8 ± 2.7	0.9 ± 2.6
Patients with severe hypoglycemia (n, %) <sup>b</sup>	—	15 (2%)	16 (2%)

<sup>a</sup> Values are Mean ± SD

<sup>b</sup> Severe hypoglycemia refers to hypoglycemia for which patients were not able to self-treat.

## 16 HOW SUPPLIED/STORAGE AND HANDLING

Product: 50090-4488

NDC: 50090-4488-0 10 mL in a VIAL / 1 in a CARTON

## **17 PATIENT COUNSELING INFORMATION**

Advise the patient to read the FDA-approved patient labeling (Patient Information and Instructions for Use).

### Never Share a HUMALOG Prefilled Pen, Cartridge, Reusable Pen Compatible with Lilly 3 mL Cartridges, or Syringe Between Patients

Advise patients that they must never share a HUMALOG prefilled pen, cartridge, or reusable pen compatible with Lilly 3 mL cartridges with another person, even if the needle is changed. Advise patients using HUMALOG vials not to share needles or syringes with another person. Sharing poses a risk for transmission of blood-borne pathogens [see *Warnings and Precautions (5.1)*].

### Hyperglycemia or Hypoglycemia

Instruct patients on self-management procedures including glucose monitoring, proper injection technique, and management of hypoglycemia and hyperglycemia, especially at initiation of HUMALOG therapy. Instruct patients on handling of special situations such as intercurrent conditions (illness, stress, or emotional disturbances), an inadequate or skipped insulin dose, inadvertent administration of an increased insulin dose, inadequate food intake, and skipped meals. Instruct patients on the management of hypoglycemia.

Inform patients that their ability to concentrate and react may be impaired as a result of hypoglycemia. Advise patients who have frequent hypoglycemia or reduced or absent warning signs of hypoglycemia to use caution when driving or operating machinery [see *Warnings and Precautions (5.3)*].

Advise patients that changes in insulin regimen can predispose to hyperglycemia or hypoglycemia and that changes in insulin regimen should be made under close medical supervision [see *Warnings and Precautions (5.2)*].

### Hypoglycemia due to Medication Errors

Instruct patients to always check the insulin container label before each injection to avoid mix-ups between insulin products [see *Warnings and Precautions (5.4)*].

Inform patients that HUMALOG U-200 contains 2 times as much insulin per mL as HUMALOG U-100. The HUMALOG U-200 KwikPen dose window shows the number of units of HUMALOG U-200 to be injected so no dose conversion is required [see *Dosage and Administration (2.1)*].

Instruct patients to NOT transfer HUMALOG U-200 from the HUMALOG U-200 KwikPen to a syringe. The markings on the syringe will not measure the dose correctly and this can result in overdosage and severe hypoglycemia. [see *Warnings and Precautions (5.4)*].

### Hypersensitivity Reactions

Advise patients that hypersensitivity reactions have occurred with HUMALOG. Inform patients on the symptoms of hypersensitivity reactions [see *Warnings and Precautions (5.5)*].

### Administration Instruction for HUMALOG U-200

Instruct patients to NOT mix HUMALOG U-200 with any other insulin.

## Instructions For Patients Using Continuous Subcutaneous Insulin Pumps

- Do not use HUMALOG U-200 in a subcutaneous insulin pump.
- Train patients in intensive insulin therapy with multiple injections and in the function of their pump and pump accessories.
- Instruct patients to follow healthcare provider recommendations when setting pump basal rates and bolus settings.
- Refer to the continuous subcutaneous infusion pump user manual to see if HUMALOG can be used with the pump. See recommended reservoir and infusion sets in the insulin pump user manual.
- Instruct patients to replace insulin in the reservoir at least every 7 days, or according to the pump user manual, whichever is shorter; infusion sets and infusion set insertion sites should be changed in accordance with the manufacturers' user manual. By following this schedule, patients avoid insulin degradation, infusion set occlusion, and loss of the insulin preservative.
- Instruct patients to discard insulin exposed to temperatures higher than 98.6°F (37°C). The temperature of the insulin may exceed ambient temperature when the pump housing, cover, tubing or sport case is exposed to sunlight or radiant heat.
- Instruct patients to inform healthcare provider and select a new site for infusion if infusion site becomes erythematous, pruritic, or thickened.
- Instruct patients on the risk of rapid hyperglycemia and ketosis due to pump malfunction, infusion set occlusion, leakage, disconnection or kinking, and degraded insulin. Instruct patients on the risk of hypoglycemia from pump malfunction. If these problems cannot be promptly corrected, instruct patients to resume therapy with subcutaneous insulin injection and contact their healthcare provider [*see Warnings and Precautions (5) and How Supplied/Storage and Handling (16.2)*].

Manufactured by:  
Eli Lilly and Company  
Indianapolis, IN 46285, USA  
US License Number 1891

<sup>1</sup> 3 mL cartridge is for use in compatible insulin delivery devices, including HumaPen<sup>®</sup> Luxura<sup>®</sup> HD

Humalog<sup>®</sup>, Humalog KwikPen<sup>®</sup>, Humalog Tempo Penä, Humalog<sup>®</sup> Junior KwikPen<sup>®</sup>, HumaPen<sup>®</sup>, HumaPen<sup>®</sup> Luxura<sup>®</sup> and HumaPen<sup>®</sup> Luxura<sup>®</sup> HD are trademarks of Eli Lilly and Company.

[www.humalog.com](http://www.humalog.com)

Copyright © 1996, 2023, Eli Lilly and Company. All rights reserved.

LOG-0011-USPI-20230802

## **U-100 Patient Package Insert**

**PATIENT INFORMATION**  
**HUMALOG<sup>®</sup> (HU-ma-log)**  
**(insulin lispro)**  
**injection, for subcutaneous or intravenous use**  
**100 units per mL**



**Do not share your Humalog prefilled pens, cartridges, reusable pen compatible with Lilly 3 mL cartridges, needles, or syringes with other people, even if the needle has been changed. You may give other people a serious infection or get a serious infection from them.**

### **What is HUMALOG?**

- HUMALOG is a man-made fast-acting insulin used to control high blood sugar in adults and children with diabetes mellitus.

### **Who should not take HUMALOG?**

#### **Do not take HUMALOG if you:**

- are having an episode of low blood sugar (hypoglycemia).
- have an allergy to HUMALOG or any of the ingredients in HUMALOG. See the end of this Patient Information leaflet for a complete list of ingredients in HUMALOG.

### **What should I tell my healthcare provider before taking HUMALOG?**

#### **Before taking HUMALOG, tell your healthcare provider about all of your medical conditions, including if you:**

- have kidney or liver problems.
- take any other medicines, especially ones called TZDs (thiazolidinediones).
- have heart failure or other heart problems. If you have heart failure, it may get worse while you take TZDs with HUMALOG.
- are pregnant or plan to become pregnant. Talk with your healthcare provider about the best way to control your blood sugar if you plan to become pregnant or while you are pregnant.
- are breastfeeding or plan to breastfeed. Talk with your healthcare provider about the best way to feed your baby while taking HUMALOG.

**Tell your healthcare provider about all the medicines you take,** including prescription and over-the-counter medicines, vitamins, and herbal supplements.

**Before you start taking HUMALOG, talk to your healthcare provider about low blood sugar and how to manage it.**

### **How should I take HUMALOG?**

- Read the **Instructions for Use** that comes with your HUMALOG.
- Take HUMALOG exactly as your healthcare provider tells you to. Your healthcare provider should tell you how much HUMALOG to take and when to take it.
- **HUMALOG starts acting fast. Inject HUMALOG within 15 minutes before or right after you eat a meal.**
- Know the type, strength and amount of insulin you take. **Do not** change the type or amount of insulin you take unless your healthcare provider tells you to. The amount of insulin and the best time for you to take your insulin may need to change if you take different types of insulin.
- Check your insulin label each time you give your injection to make sure you are taking the correct insulin.
- Inject HUMALOG under the skin (subcutaneously) of your stomach area, buttocks, upper legs or upper arms, or by continuous infusion under the skin (subcutaneously) through an insulin pump into an area of your body recommended in the instructions that come with your insulin pump.
- **Change (rotate) your injection sites within the area you choose with each dose** to reduce your risk of getting lipodystrophy (pits in skin or thickened skin) and

localized cutaneous amyloidosis (skin with lumps) at the injection sites.

- **Do not** use the exact same spot for each injection.
- **Do not** inject where the skin has pits, is thickened, or has lumps.
- **Do not** inject where the skin is tender, bruised, scaly or hard, or into scars or damaged skin.
- **Always use a new needle for each injection to help prevent infections and blocked needles. Do not reuse or share your needles with other people. You may give other people a serious infection or get a serious infection from them.**
- **Check your blood sugar levels.** Ask your healthcare provider what your blood sugars should be and when you should check your blood sugar levels.

**Keep HUMALOG and all medicines out of the reach of children.**

**Your dose of HUMALOG may need to change because of a:**

- change in physical activity or exercise, weight gain or loss, increased stress, illness, change in diet, or because of other medicines you take.

**What should I avoid while taking HUMALOG?**

**While taking HUMALOG do not:**

- drive or operate heavy machinery, until you know how HUMALOG affects you.
- drink alcohol or take prescription or over-the-counter medicines that contain alcohol.

**What are the possible side effects of HUMALOG?**

**HUMALOG may cause serious side effects that can lead to death, including:**

- **low blood sugar (hypoglycemia).** Signs and symptoms of low blood sugar may include:
  - dizziness or light-headedness
  - sweating
  - confusion
  - headache
  - blurred vision
  - slurred speech
  - shakiness
  - fast heartbeat
  - anxiety, irritability or mood changes
  - hunger

Your healthcare provider may prescribe a glucagon product for emergency use so that someone else can give you glucagon if your blood sugar becomes too low (severe hypoglycemia) and you are unable to take sugar by mouth.

- **serious allergic reactions (whole body allergic reaction). Get medical help right away, if you have any of these signs or symptoms of a severe allergic reaction:**

- a rash over your whole body
- trouble breathing
- a fast heartbeat
- sweating
- feel faint

- **low potassium in your blood (hypokalemia).**
- **heart failure.** Taking certain diabetes pills called thiazolidinediones or “TZDs” with HUMALOG may cause heart failure in some people. This can happen even if you have never had heart failure or heart problems before. If you already have heart failure it may get worse while you take TZDs with HUMALOG. Your healthcare provider should

monitor you closely while you are taking TZDs with HUMALOG. Tell your healthcare provider if you have any new or worse symptoms of heart failure including:

- shortness of breath
- swelling of your ankles or feet
- sudden weight gain

Treatment with TZDs and HUMALOG may need to be adjusted or stopped by your healthcare provider if you have new or worse heart failure.

**Get emergency medical help if you have:**

- trouble breathing
- shortness of breath
- fast heartbeat
- swelling of your face, tongue, or throat
- sweating
- extreme drowsiness
- dizziness
- confusion

**The most common side effects of HUMALOG include:**

- low blood sugar (hypoglycemia)
- reactions at your injection site
- skin thickening or pits at the injection site (lipodystrophy)
- weight gain
- swelling in your hands or feet
- itching
- rash

**These are not all the possible side effects of HUMALOG.** Call your doctor for medical advice about side effects. You may report side effects to FDA at 1-800-FDA-1088.

**General information about the safe and effective use of HUMALOG.**

Medicines are sometimes prescribed for purposes other than those listed in a Patient Information leaflet. Do not take HUMALOG for a condition for which it was not prescribed. Do not give HUMALOG to other people, even if they have the same symptoms that you have. It may harm them.

This Patient Information leaflet summarizes the most important information about HUMALOG. If you would like more information, talk with your healthcare provider. You can ask your pharmacist or healthcare provider for information about HUMALOG that is written for health professionals.

**What are the ingredients in HUMALOG?**

**Active ingredient:** insulin lispro

**Inactive ingredients:** dibasic sodium phosphate, glycerin, hydrochloric acid, metacresol, trace amounts of phenol, sodium hydroxide, zinc oxide (zinc ion), and Water for Injection, USP.

Humalog® is a registered trademark of Eli Lilly and Company.

Manufactured by: Eli Lilly and Company, Indianapolis, IN 46285, USA, US License Number 1891

Copyright © 1996, 2023, Eli Lilly and Company. All rights reserved.

For more information, go to [www.humalog.com](http://www.humalog.com) or call 1-800-545-5979.

This Patient Information has been approved by the U.S. Food and Drug Administration

Revised: July 2023

LOG-0007-PPI-20230721

**U-100 Vial Instructions for Use**

## INSTRUCTIONS FOR USE

### HUMALOG® (HU-ma-log) (insulin lispro) injection, for subcutaneous use

#### 3 mL or 10 mL multiple-dose vial (100 units per mL, U-100)

Read this Instructions for Use before you start taking HUMALOG and each time you get a new vial. There may be new information. This information does not take the place of talking to your healthcare provider about your medical condition or your treatment.

**Do not share your needles or syringes with other people, even if the needle has been changed. You may give other people a serious infection or get a serious infection from them.**

#### Supplies needed to give your injection

- a multiple-dose HUMALOG vial
- a U-100 insulin syringe and needle
- 2 alcohol swabs
- gauze
- 1 sharps container for throwing away used needles and syringes. See **“Disposing of used needles and syringes”** at the end of these instructions.

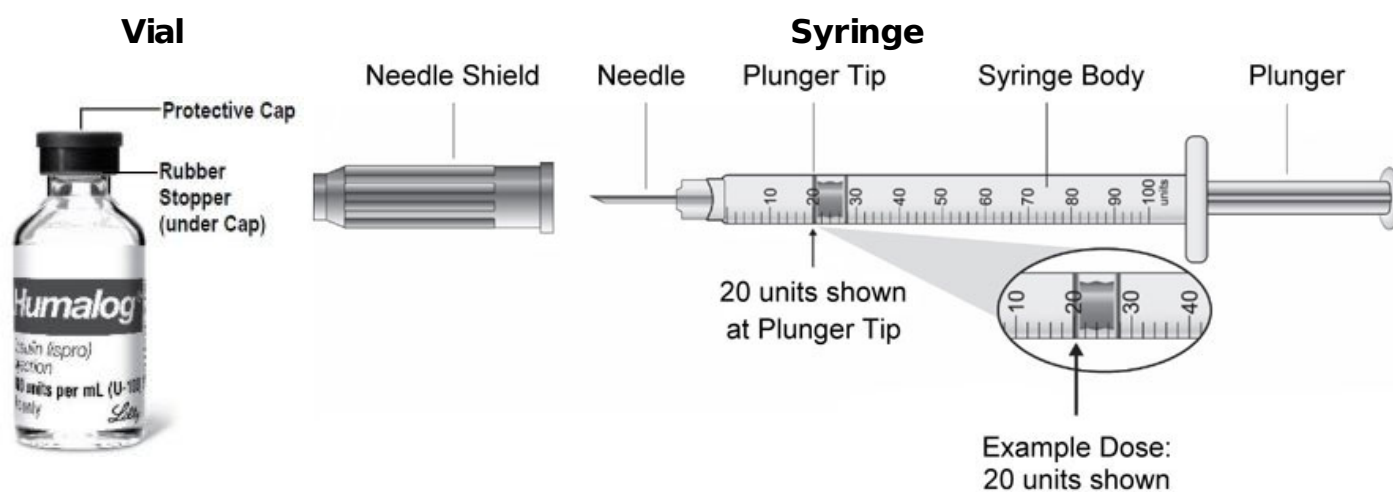

#### Preparing your HUMALOG dose

- Wash your hands with soap and water.
- Check the HUMALOG label to make sure you are taking the right type of insulin. This is especially important if you use more than 1 type of insulin.
- HUMALOG should look clear and colorless. **Do not** use HUMALOG if it is thick, cloudy, or colored, or if you see lumps or particles in it.
- **Do not** use HUMALOG past the expiration date printed on the label or 28 days after you first use it.
- **Always use a new syringe and needle for each injection to prevent infections and blocked needles. Do not reuse or share your syringes or needles with other people. You may give other people a serious infection or get a serious infection from them.**

**Step 1:**

If you are using a new vial, pull off the plastic Protective Cap, but **do not** remove the Rubber Stopper.

**Step 2:**

Wipe the Rubber Stopper with an alcohol swab.

**Step 3:**

Remove the Needle Shield from the syringe by pulling the Needle Shield straight off. Hold the syringe with the needle pointing up. Pull down on the Plunger until the Plunger Tip reaches the line for the number of units for your prescribed dose.

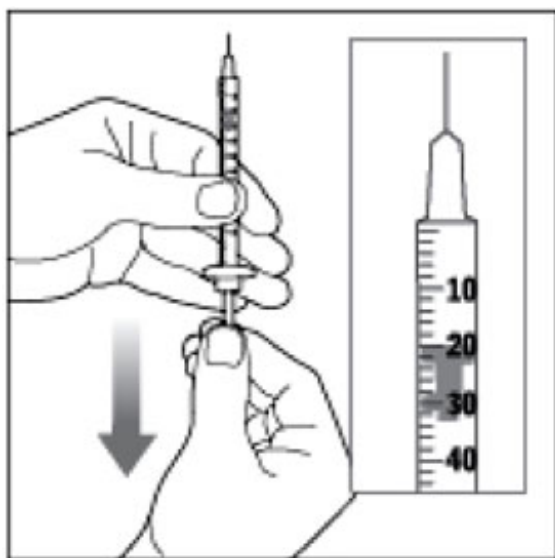

(Example Dose: 20 units shown)

**Step 4:**

Push the needle through the Rubber Stopper of the vial.



**Step 5:**

Push the Plunger all the way in. This puts air into the vial.

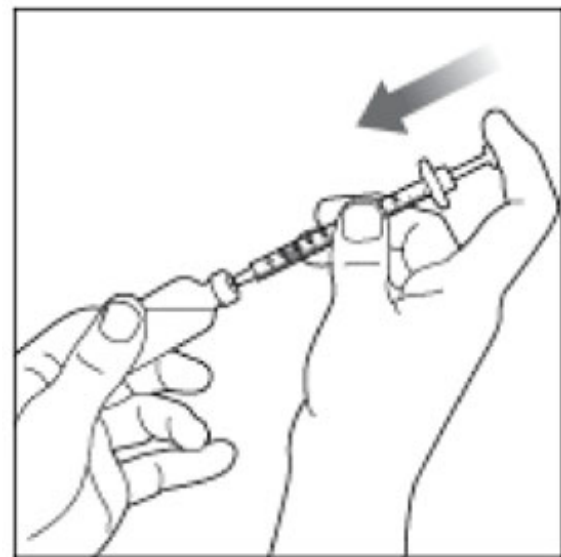

**Step 6:**

Turn the vial and syringe upside down and slowly pull the Plunger down until the Plunger Tip is a few units past the line for your prescribed dose.

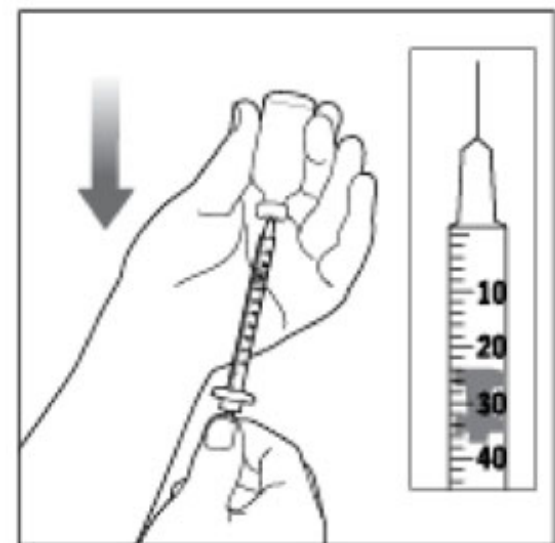

(Example Dose: 20 units  
Plunger is shown at 24 units)

If there are air bubbles, tap the syringe gently

a few times to let any air bubbles rise to the top.



**Step 7:**

Slowly push the Plunger up until the Plunger Tip reaches the line for your prescribed dose. Check the syringe to make sure that you have the right dose.

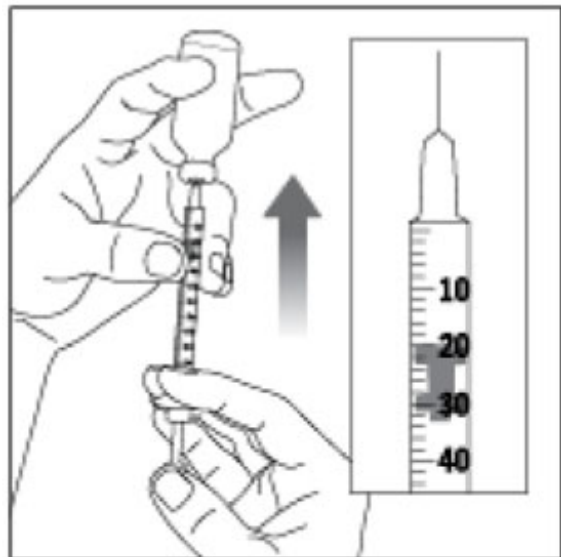

(Example Dose: 20 units shown)

**Step 8:**

Pull the syringe out of the Rubber Stopper of the vial.

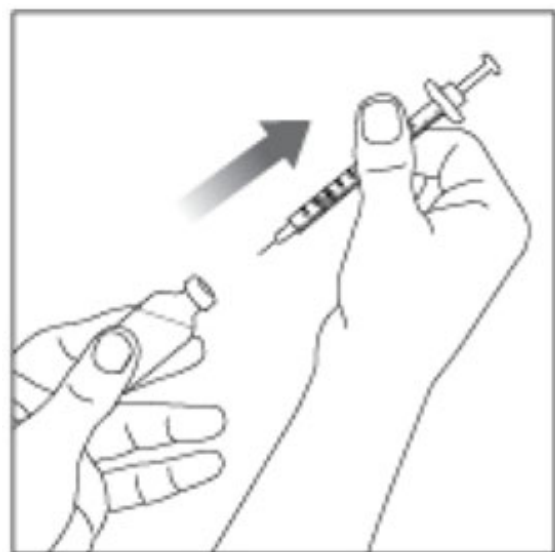

**If you use HUMALOG with NPH insulin:**

- NPH insulin is the **only** type of insulin that can be mixed with HUMALOG. Do not mix HUMALOG with any other type of insulin.

- HUMALOG should be drawn up into the syringe first, before you draw up your NPH insulin. Talk to your healthcare provider if you are not sure about the right way to mix HUMALOG and NPH insulin.
- Give your injection right away.

### Giving your HUMALOG injection with a syringe

- Inject your insulin exactly as your healthcare provider has shown you. Your healthcare provider should tell you if you should pinch the skin before injecting.
- **HUMALOG starts acting fast**, so give your injection within 15 minutes before or right after you eat a meal.
- Change (rotate) your injection sites within the area you choose for each dose to reduce your risk of getting lipodystrophy (pits in skin or thickened skin) and localized cutaneous amyloidosis (skin with lumps) at the injection sites.
- **Do not** inject where the skin has pits, is thickened, or has lumps.
- **Do not** inject where the skin is tender, bruised, scaly or hard, or into scars or damaged skin.

#### Step 9:

Choose your injection site.  
 HUMALOG is injected under the skin (subcutaneously) of your stomach area (abdomen), buttocks, upper legs or upper arms.  
 Wipe the skin with an alcohol swab. Let the injection site dry before you inject your dose.

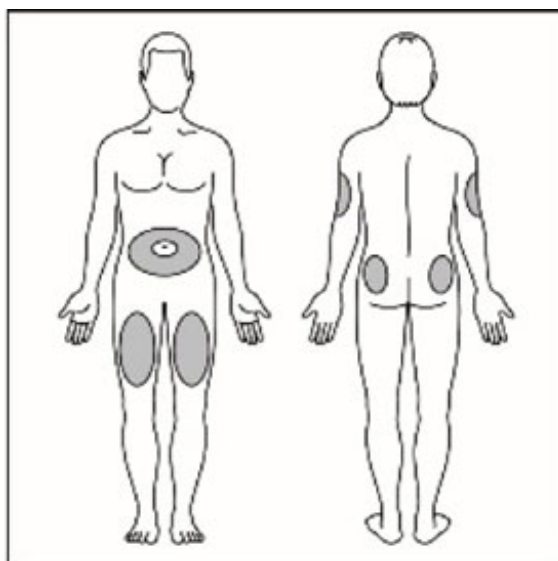

#### Step 10:

Insert the needle into your skin.



#### Step 11:



Push down on the Plunger to inject your dose. The needle should stay in your skin for at least 5 seconds to make sure you have injected all of your insulin dose.

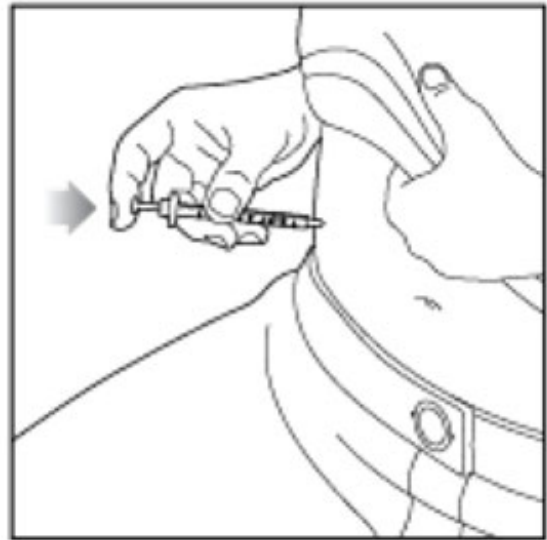

### Step 12:

Pull the needle out of your skin.

- If you see blood after you take the needle out of your skin, press the injection site with a piece of gauze or an alcohol swab. **Do not** rub the area.
- **Do not** recap the needle. Recapping the needle can lead to a needle stick injury.

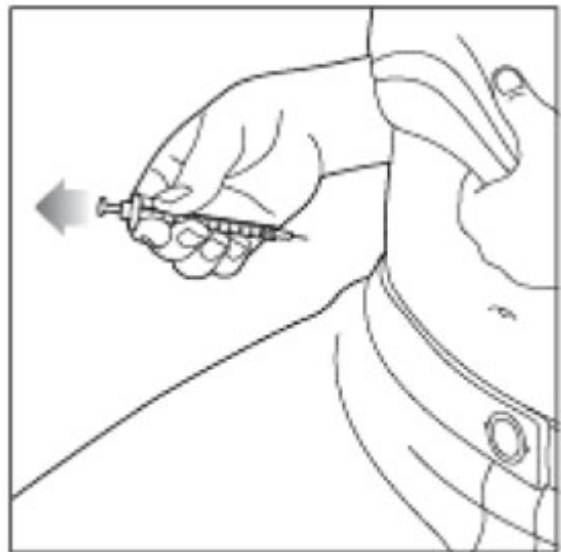

### Giving your HUMALOG using an insulin pump

- HUMALOG should be given into an area of your body recommended in the instructions that come with your insulin pump.
- Change your infusion set and rotate the infusion set insertion site according to the manufacturer's user manual.
- Change (rotate) your insertion sites within the area you choose for each insertion to reduce your risk of getting lipodystrophy (pits in skin or thickened skin) and localized cutaneous amyloidosis (skin with lumps) at the insertion sites. **Do not** insert into the exact same spot for each insertion. **Do not** insert where the skin has pits, is thickened, or has lumps. **Do not** insert where the skin is tender, bruised, scaly or hard, or into scars or damaged skin.
- Change the insulin in the reservoir at least every 7 days or according to the pump user manual, whichever is shorter, even if you have not used all of the insulin.
- **Do not** dilute or mix HUMALOG with any other type of insulin in your insulin pump.
- See your insulin pump manual for instructions or talk to your healthcare provider.

### Disposing of used needles and syringes

- Put your used needles and syringes in a FDA-cleared sharps disposal container right away after use. **Do not** throw away (dispose of) loose needles and syringes in your

household trash.

- If you do not have a FDA-cleared sharps disposal container, you may use a household container that is:
  - made of a heavy-duty plastic,
  - can be closed with a tight-fitting, puncture-resistant lid, without sharps being able to come out,
  - upright and stable during use,
  - leak-resistant, and
  - properly labeled to warn of hazardous waste inside the container.
- When your sharps disposal container is almost full, you will need to follow your community guidelines for the right way to dispose of your sharps disposal container. There may be state or local laws about how you should throw away used needles and syringes. For more information about safe sharps disposal, and for specific information about sharps disposal in the state that you live in, go to the FDA's website at: <http://www.fda.gov/safesharpsdisposal>.
- **Do not** dispose of your used sharps disposal container in your household trash unless your community guidelines permit this. **Do not** recycle your used sharps disposal container.

## **How should I store HUMALOG?**

### **All unopened vials:**

- Store all unopened vials in the refrigerator at 36°F to 46°F (2°C to 8°C).
- **Do not** freeze. **Do not** use if HUMALOG has been frozen.
- Keep away from heat and out of direct light.
- Unopened vials can be used until the expiration date on the carton and label, if they have been stored in the refrigerator.
- Unopened vials should be thrown away after 28 days, if they are stored at room temperature.

### **After vials have been opened:**

- Store opened vials in the refrigerator or at room temperature up to 86°F (30°C) for up to 28 days.
- Keep vials away from heat and out of direct light.
- Throw away all opened vials after 28 days of use, even if there is insulin left in the vial.

### **HUMALOG in an insulin pump:**

- Throw away HUMALOG in the pump reservoir if it has been exposed to temperatures higher than 98.6°F (37°C).

## **Keep HUMALOG vials, syringes, needles and all medicines out of the reach of children.**

If you have any questions or problems with your HUMALOG, contact Lilly at 1-800-Lilly-Rx (1-800-545-5979) or call your healthcare provider for help. For more information on HUMALOG and insulin, go to [www.humalog.com](http://www.humalog.com).

Manufactured by:

Eli Lilly and Company

Indianapolis, IN 46285, USA

US License Number 1891

This Instructions for Use has been approved by the U.S. Food and Drug Administration.

Revised: July 2023



Scan this code to launch the humalog.com website

Humalog® is a registered trademark of Eli Lilly and Company.

Copyright © 1996, 2023, Eli Lilly and Company. All rights reserved.

LOGVL-0009-IFU-20230721

## **KwikPen U-100 Instructions for Use**

### **INSTRUCTIONS FOR USE**

#### **HUMALOG (HU-ma-log) KwikPen®**

**(insulin lispro)**

**injection, for subcutaneous use**

**3 mL single-patient-use pen (100 units per mL)**



Read the Instructions for Use before you start taking HUMALOG® and each time you get another KwikPen®. There may be new information. This information does not take the place of talking to your healthcare provider about your medical condition or your treatment.

**Do not share your HUMALOG KwikPen with other people, even if the needle has been changed. You may give other people a serious infection or get a serious infection from them.**

HUMALOG KwikPen (“Pen”) is a disposable single-patient-use prefilled pen containing 300 units of HUMALOG. You can give yourself more than 1 dose from the Pen. Each turn (click) of the Dose Knob dials 1 unit of insulin. You can give from 1 to 60 units in a single injection. **If your dose is more than 60 units, you will need to give yourself more than 1 injection.** The Plunger only moves a little with each injection, and you may not notice that it moves. The Plunger will only reach the end of the cartridge when you have used all 300 units in the Pen.

**People who are blind or have vision problems should not use the Pen without**

help from a person trained to use the Pen.

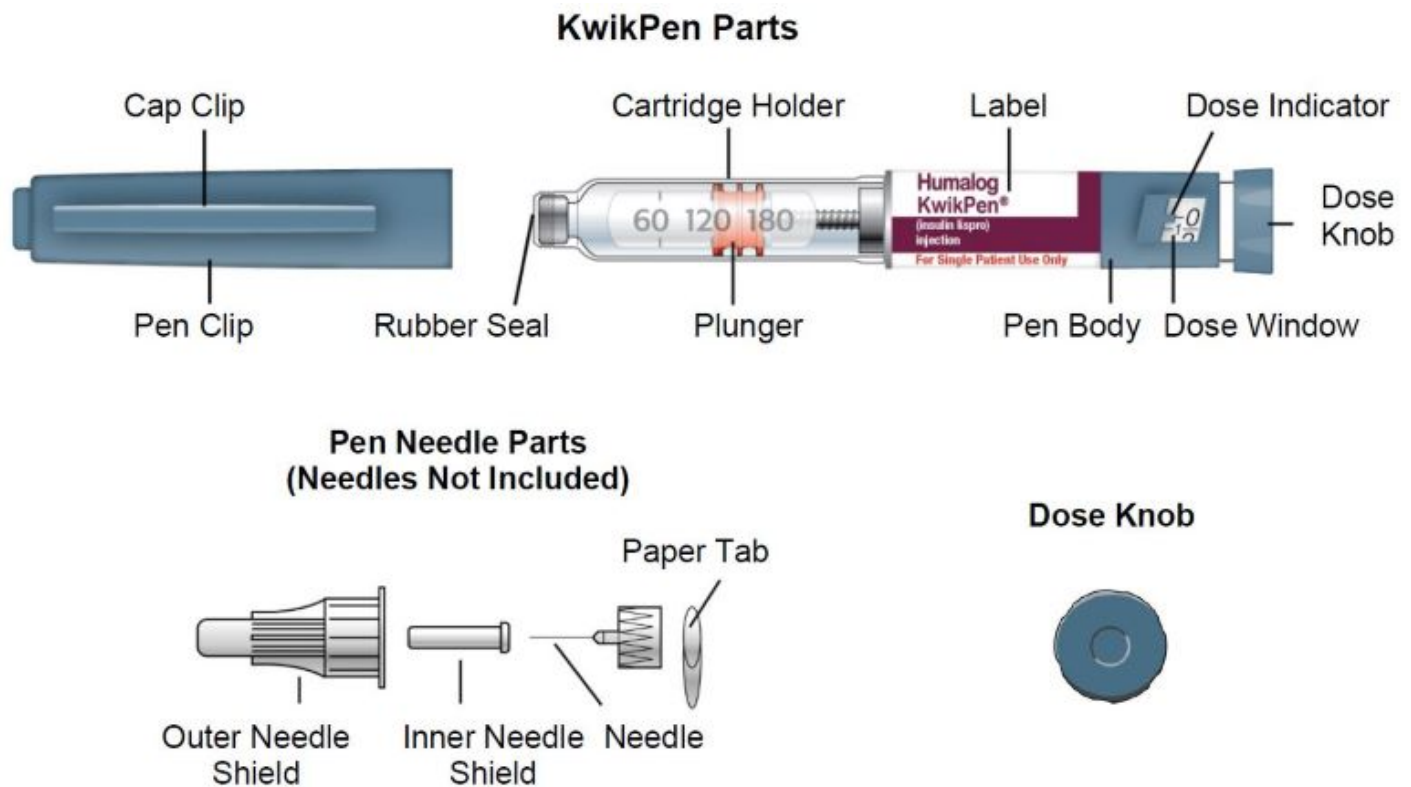

### How to recognize your HUMALOG KwikPen

- Pen color: Dark blue
- Dose Knob: Dark blue
- Labels: White label with burgundy stripe

### Supplies you will need to give your injection

- HUMALOG KwikPen
- KwikPen compatible Needle (Becton, Dickinson and Company Pen Needles recommended)
- Alcohol swab
- Gauze

### Preparing your Pen

- Wash your hands with soap and water.
- Check your Pen to make sure you are taking the right type of insulin. This is especially important if you use more than 1 type of insulin.
- **Do not** use your Pen past the expiration date printed on the Label or for more than 28 days after you first start using the Pen.
- **Always use a new needle for each injection to help prevent infections and blocked needles. Do not reuse or share your needles with other people. You may give other people a serious infection or get a serious infection from them.**

---

### Step 1:

- Pull the Pen Cap straight off.
  - **Do not** remove the Pen Label.
- Wipe the Rubber Seal with an alcohol swab.

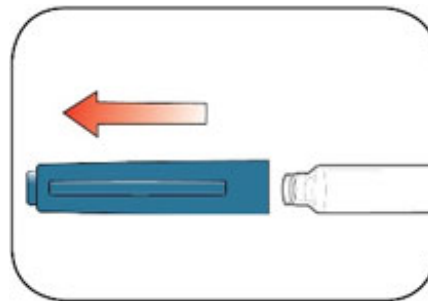

### Step 2:

- **Check the liquid in the Pen.**  
HUMALOG should look clear and colorless. **Do not** use if it is cloudy, colored, or has particles or clumps in it.

---

### Step 3:

- **Select a new Needle.**
- Pull off the Paper Tab from the Outer Needle Shield.



---

### Step 4:

- Push the capped Needle straight onto the Pen and twist the Needle on until it is tight.

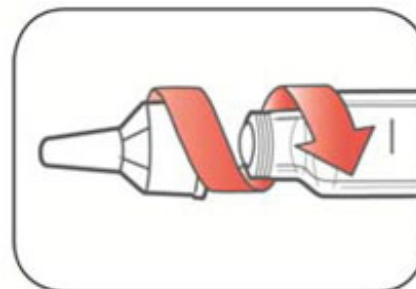

---

### Step 5:

- Pull off the Outer Needle Shield. **Do not** throw it away.
- Pull off the Inner Needle Shield and throw it away.

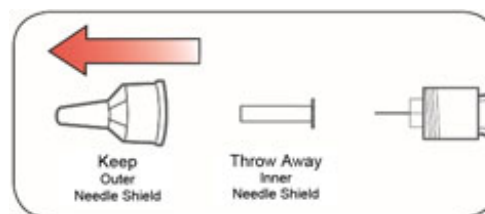

---

## Priming your Pen

### Prime before each injection.

- Priming your Pen means removing the air from the Needle and Cartridge that may collect during normal use and ensures that the Pen is working correctly.
- If you **do not** prime before each injection, you may get too much or too little insulin.

---

### Step 6:

- To prime your Pen, turn the Dose Knob to select 2 units.

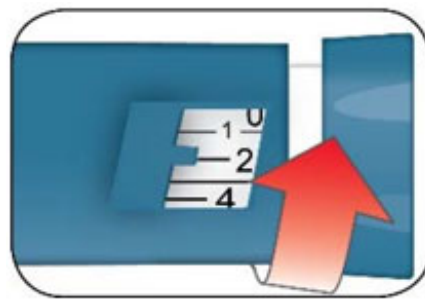

---

### Step 7:

- Hold your Pen with the Needle pointing up. Tap the Cartridge Holder gently to collect air bubbles at the top.



---

### Step 8:

- Continue holding your Pen with Needle pointing up. Push the Dose Knob in until it stops, and “0” is seen in the Dose Window. Hold the Dose Knob in and **count to 5 slowly**.

You should see insulin at the tip of the Needle.

- If you **do not** see insulin, repeat priming steps 6 to 8, no more than 4 times.
- If you **still do not** see insulin, change the Needle and repeat priming steps 6 to 8.

Small air bubbles are normal and will not affect your dose.

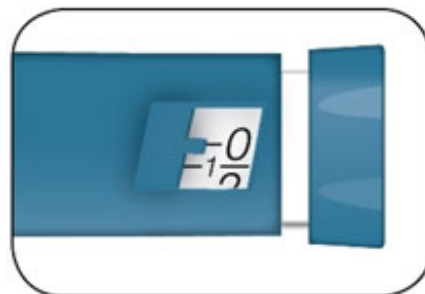
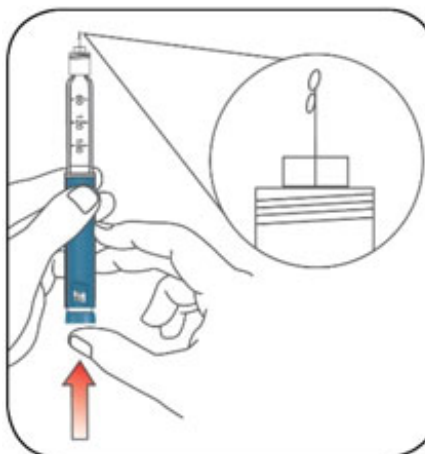

---

### Selecting your dose

- You can give from 1 to 60 units in a single injection.
- If your dose is more than 60 units, you will need to give more than 1 injection.
  - If you need help with dividing up your dose the right way, ask your healthcare provider.
  - Use a new Needle for each injection and repeat the priming step.

---

### Step 9:

- Turn the Dose Knob to select the number of units you need to inject. The Dose Indicator should line up with your dose.
  - The Pen dials 1 unit at a time.
  - The Dose Knob clicks as you turn it.
  - **Do not** dial your dose by counting the clicks. You may dial the wrong dose. This may lead to you getting too much insulin or not enough insulin.
  - The dose can be corrected by turning the Dose Knob in either direction until the correct dose lines up with the Dose Indicator.
  - The **even** numbers (for example, 12) are printed on the dial.
  - The **odd** numbers, (for example, 25) after the number 1, are shown as full lines.

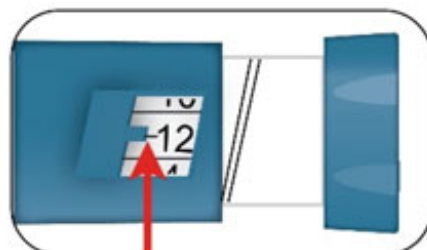
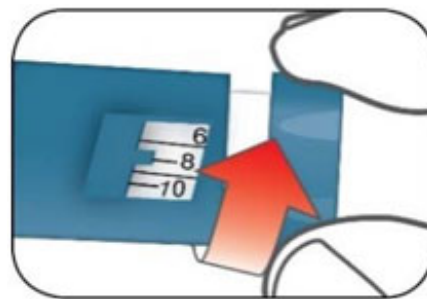

(Example: 12 units shown in the Dose Window)

- **Always check the number in the Dose Window to make sure you have dialed the correct dose.**

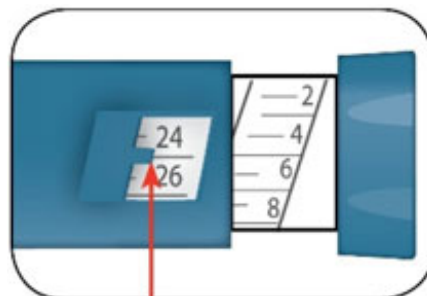

(Example: 25 units shown in the Dose Window)

- The Pen will not let you dial more than the number of units left in the Pen.
- If you need to inject more than the number of units left in the Pen, you may either:
  - inject the amount left in your Pen and then use a new Pen to give the rest of your dose, **or**
  - get a new Pen and inject the full dose.
- It is normal to see a small amount of insulin left in the Pen that you can not inject.

### Giving your injection

- Inject your insulin as your healthcare provider has shown you.
- Change (rotate) your injection sites within the area you choose for each dose to reduce your risk of getting lipodystrophy (pits in skin or thickened skin) and localized cutaneous amyloidosis (skin with lumps) at the injection sites.
- **Do not** inject where the skin has pits, is thickened, or has lumps.
- **Do not** inject where the skin is tender, bruised, scaly or hard, or into scars or

damaged skin.

- **Do not** try to change your dose while injecting.

---

### Step 10:

- Choose your injection site.  
HUMALOG is injected under the skin (subcutaneously) of your stomach area, buttocks, upper legs or upper arms.
- Wipe your skin with an alcohol swab, and let your skin dry before you inject your dose.

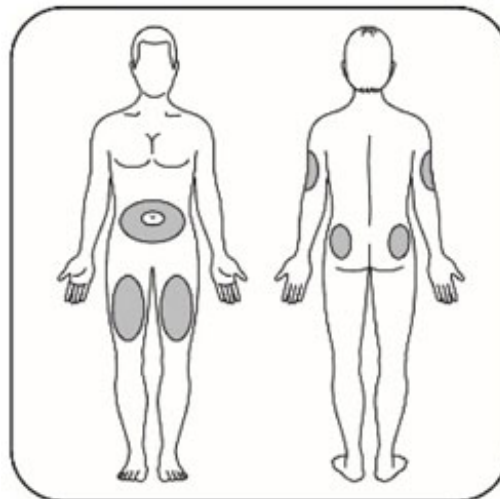

---

### Step 11:

- Insert the Needle into your skin.
- Push the Dose Knob all the way in.
- Continue to hold the Dose Knob in and **slowly count to 5** before removing the Needle.



**Do not** try to inject your insulin by turning the Dose Knob. You will **not** receive your insulin by turning the Dose Knob.

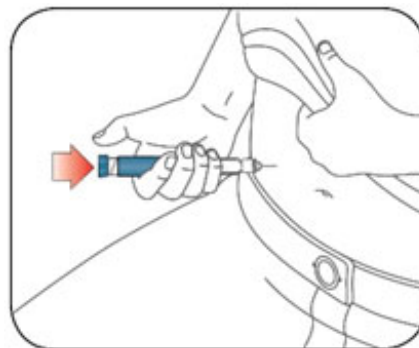

---

### Step 12:

- Pull the Needle out of your skin.  
A drop of insulin at the Needle tip is normal. It will not affect your dose.
- Check the number in the Dose Window.
  - If you see "0" in the Dose Window, you have received the full amount you dialed.
  - If you do not see "0" in the Dose Window, do not redial. Insert the Needle into your skin and finish your injection.
  - If you **still** do not think you received the full amount you dialed for your injection, **do not start over or repeat the injection.** Monitor your

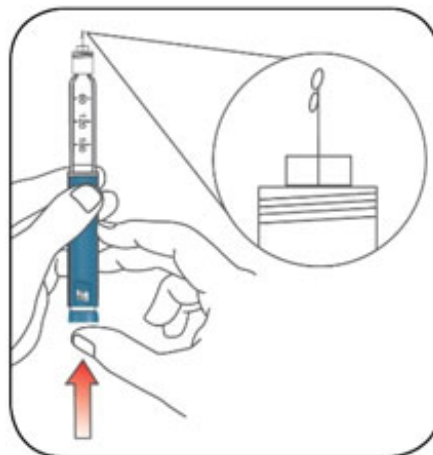



blood glucose as instructed by your healthcare provider.

- If you normally need to give 2 injections for your full dose, be sure to give your second injection.

The Plunger only moves a little with each injection, and you may not notice that it moves.

If you see blood after you take the Needle out of your skin, press the injection site lightly with a piece of gauze or an alcohol swab. **Do not** rub the area.

---

## After your injection

---

### Step 13:

- Carefully replace the Outer Needle Shield.

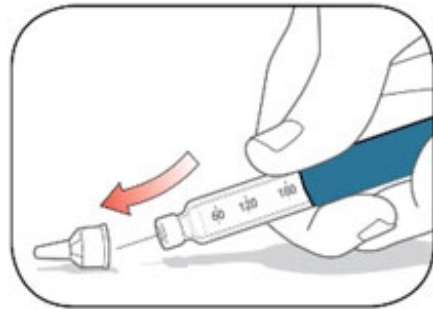

### Step 14:

- Unscrew the capped Needle and throw it away (see **Disposing of Pens and Needles** section).
- **Do not** store the Pen with the Needle attached to prevent leaking, blocking the Needle, and air from entering the Pen.

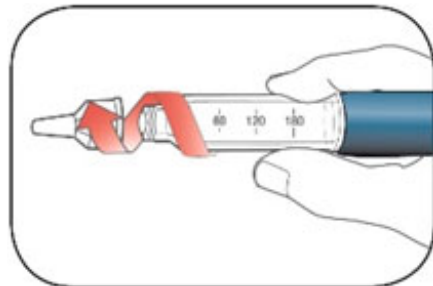

### Step 15:

- Replace the Pen Cap by lining up the Cap Clip with the Dose Indicator and pushing straight on.

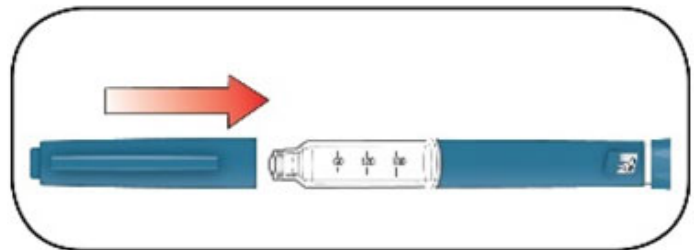

## Disposing of Pens and Needles

- The used Pen may be discarded in your household trash after you have removed the needle.
- Put your used needles in a FDA-cleared sharps disposal container right away after use. Do not throw away (dispose of) loose needles in your household trash.
- If you do not have a FDA-cleared sharps disposal container, you may use a household container that is:

- made of a heavy-duty plastic,
  - can be closed with a tight-fitting, puncture-resistant lid, without sharps being able to come out,
  - upright and stable during use,
  - leak-resistant, and
  - properly labeled to warn of hazardous waste inside the container.
- When your sharps disposal container is almost full, you will need to follow your community guidelines for the right way to dispose of your sharps disposal container. There may be state or local laws about how you should throw away used needles and syringes. For more information about safe sharps disposal, and for specific information about sharps disposal in the state that you live in, go to the FDA's website at: <http://www.fda.gov/safesharpsdisposal>
  - Do not dispose of your used sharps disposal container in your household trash unless your community guidelines permit this. Do not recycle your used sharps disposal container.

## Storing your Pen

### Unused Pens

- Store unused Pens in the refrigerator at 36°F to 46°F (2°C to 8°C).
- **Do not** freeze your insulin. **Do not** use if it has been frozen.
- Unused Pens may be used until the expiration date printed on the Label, if the Pen has been kept in the refrigerator.

### In-use Pen

- Store the Pen you are currently using at room temperature [up to 86°F (30°C)]. Keep away from heat and light.
- Throw away the HUMALOG Pen you are using after 28 days, even if it still has insulin left in it.

## General information about the safe and effective use of your Pen

- **Keep your Pen and needles out of the reach of children.**
- **Do not** use your Pen if any part looks broken or damaged.
- Always carry an extra Pen in case yours is lost or damaged.

## Troubleshooting

- If you can not remove the Pen Cap, gently twist the cap back and forth, and then pull the cap straight off.
- If the Dose Knob is hard to push:
  - Pushing the Dose Knob more slowly will make it easier to inject.
  - Your Needle may be blocked. Put on a new Needle and prime the Pen.
  - You may have dust, food, or liquid inside the Pen. Throw the Pen away and get a new Pen.

If you have any questions or problems with your HUMALOG KwikPen, contact Lilly at 1-800-LillyRx (1-800-545-5979) or call your healthcare provider for help. For more information on HUMALOG KwikPen and insulin, go to [www.humalog.com](http://www.humalog.com).

Manufactured by:

Eli Lilly and Company  
Indianapolis, IN 46285, USA  
US License Number 1891

This Instructions for Use has been approved by the U.S. Food and Drug Administration.

Revised: July 2023



Scan this code to launch ([www.humalog.com](http://www.humalog.com))

HUMALOG® and HUMALOG KwikPen® are registered trademarks of Eli Lilly and Company.

Copyright © 2007, 2023, Eli Lilly and Company. All rights reserved.

**HUMALOG KwikPen** meets the current dose accuracy and functional requirements of ISO 11608-1.

LOGKP-0009-IFU-20230721

## Junior KwikPen U-100 Vial Instructions for Use

### INSTRUCTIONS FOR USE

**HUMALOG® (HU-ma-log) Junior KwikPen®**

**(insulin lispro)**

**injection, for subcutaneous use**

**3 mL single-patient-use pen (100 units per mL)**



Read the Instructions for Use before you start taking HUMALOG and each time you get another HUMALOG® Junior KwikPen®. There may be new information. This information does not take the place of talking to your healthcare provider about your medical condition or your treatment.

**Do not share your HUMALOG Junior KwikPen with other people, even if the needle has been changed. You may give other people a serious infection or get a serious infection from them.**

HUMALOG Junior KwikPen (“Pen”) is a disposable single-patient-use prefilled pen

containing 300 units of HUMALOG.

- You can give yourself more than 1 dose from the Pen.
- Each turn of the Dose Knob dials 0.5 ( $\frac{1}{2}$ ) unit of insulin. You can give from 0.5 ( $\frac{1}{2}$ ) to 30 units in a single injection.
- If your dose is more than 30 units, you will need to give yourself more than 1 injection.
- The Plunger only moves a little with each injection, and you may not notice that it moves. The Plunger will only reach the end of the cartridge when you have used all 300 units in the Pen.

**People who are blind or have vision problems should not use the Pen without help from a person trained to use the Pen.**

### HUMALOG Junior KwikPen Parts

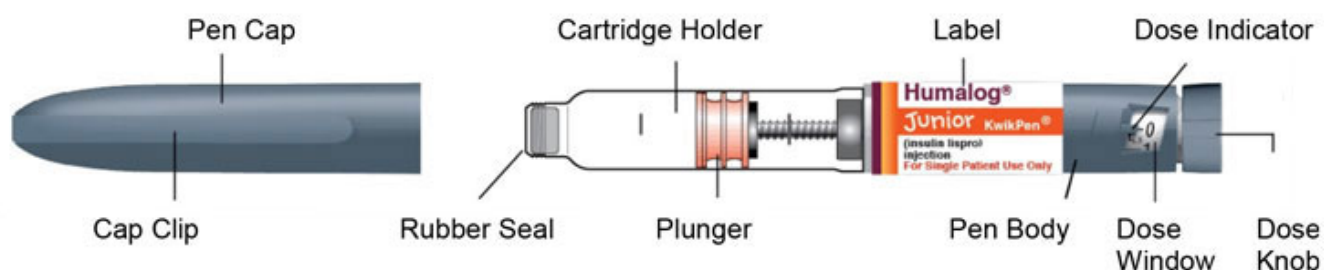

### Pen Needle Parts (Needles Not Included)

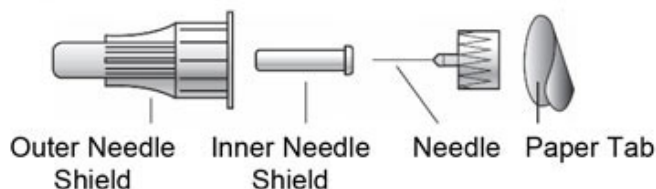

### Dose Knob



### How to recognize your HUMALOG Junior KwikPen:

- Pen color: Blue
- Dose Knob: Blue, with raised ridges on end and side
- Label: White with an orange color bar and orange-to-yellow color band



### Supplies needed to give your injection:

- HUMALOG Junior KwikPen
- KwikPen compatible Needle (BD [Becton, Dickinson and Company] Pen Needles recommended)
- Alcohol swab
- Gauze

### Preparing your Pen

- Wash your hands with soap and water.
- Check the Pen to make sure you are taking the right type of insulin. This is especially important if you use more than 1 type of insulin.

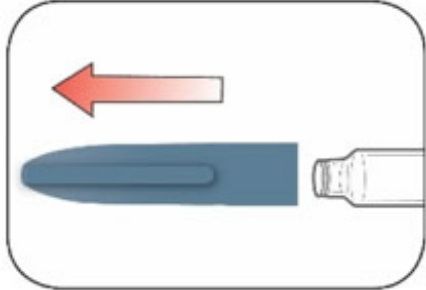
- **Do not** use your Pen past the expiration date printed on the Label or for more than 28 days after you first start using the Pen.
- **Always use a new needle for each injection to help prevent infections and blocked needles. Do not reuse or share your needles with other people. You may give other people a serious infection or get a serious infection from them.**

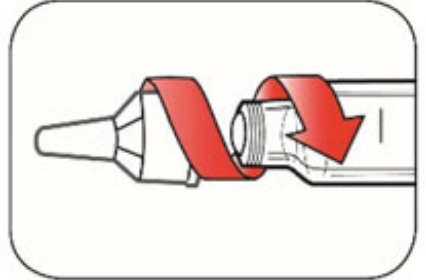
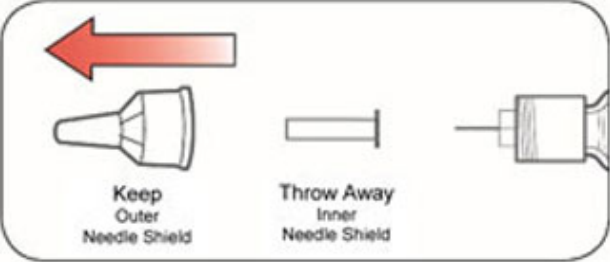
<p><b>Step 1:</b></p> <ul style="list-style-type: none"> <li>• Pull the Pen Cap straight off. <ul style="list-style-type: none"> <li>- <b>Do not</b> remove the Pen Label.</li> </ul> </li> <li>• Wipe the Rubber Seal with an alcohol swab.</li> </ul> <p><b>Step 2:</b></p> <ul style="list-style-type: none"> <li>• Check the liquid in the Pen. HUMALOG should look clear and colorless. <b>Do not</b> use if it is cloudy, colored, or has particles or clumps in it.</li> </ul>	
<p><b>Step 3:</b></p> <ul style="list-style-type: none"> <li>• Select a new Needle.</li> <li>• Pull off the Paper Tab from the Outer Needle Shield.</li> </ul>	
<p><b>Step 4:</b></p> <ul style="list-style-type: none"> <li>• Push the capped Needle straight onto the Pen and twist the Needle on until it is tight.</li> </ul>	
<p><b>Step 5:</b></p> <ul style="list-style-type: none"> <li>• Pull off the Outer Needle Shield. <b>Do not</b> throw it away.</li> <li>• Pull off the Inner Needle Shield and throw it away.</li> </ul>	

## Priming your Pen

### Prime before each injection.

- Priming your Pen means removing the air from the Needle and Cartridge that may

collect during normal use and ensures that the Pen is working correctly.

- If you **do not** prime before each injection, you may get too much or too little insulin.

### Step 6:

- To prime your Pen, turn the Dose Knob to select 2 units.

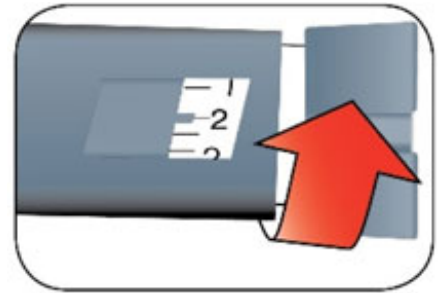

### Step 7:

- Hold your Pen with the Needle pointing up. Tap the Cartridge Holder gently to collect air bubbles at the top.

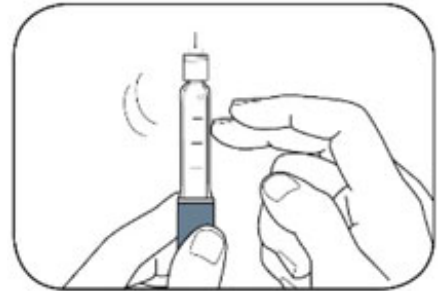

### Step 8:

- Continue holding your Pen with Needle pointing up. Push the Dose Knob in until it stops, and "0" is seen in the Dose Window. Hold the Dose Knob in and **count to 5 slowly**.

You should see insulin at the tip of the Needle.

- If you **do not** see insulin, repeat priming steps 6 to 8, no more than 4 times.
- If you **still do not** see insulin, change the Needle and repeat priming steps 6 to 8.

Small air bubbles are normal and will not affect your dose.

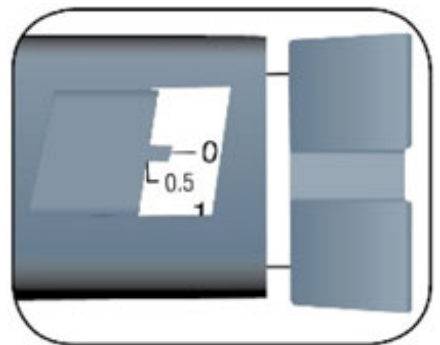
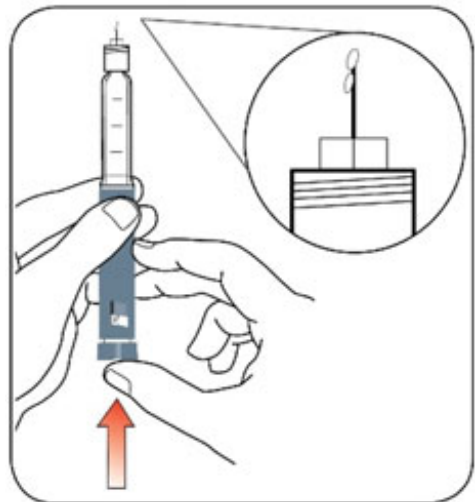

### Selecting your dose

- You can give from 0.5 ( $\frac{1}{2}$ ) to 30 units in a single injection.
- If your dose is more than 30 units, you will need to give more than 1 injection.

- If you need help with dividing up your dose the right way, ask your healthcare provider.
- You must use a new Needle for each injection and repeat the priming step.

### Step 9:

- Turn the Dose Knob to select the number of units you need to inject. The Dose Indicator should line up with your dose.
  - The Pen dials 0.5 ( $\frac{1}{2}$ ) unit at a time.
  - The Dose Knob clicks as you turn it.
  - **Do not** dial your dose by counting the clicks. You may dial the wrong dose. This may lead to you getting too much insulin or not enough insulin.
  - The dose can be corrected by turning the Dose Knob in either direction until the correct dose lines up with the Dose Indicator.
  - The **whole unit** numbers (for example, 4) are printed on the dial.
  - The **half units** are shown as lines between the whole unit numbers.
- **Always check the number in the Dose Window to make sure you have dialed the correct dose.**

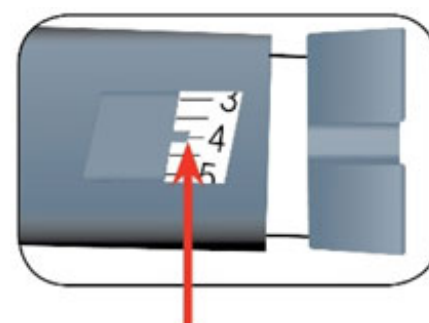
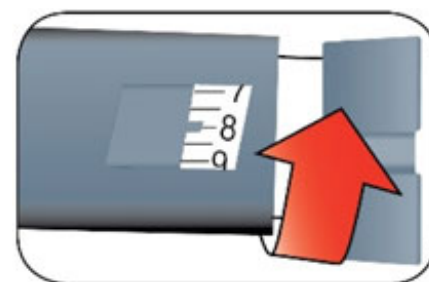

Example: 4 units shown in the Dose Window

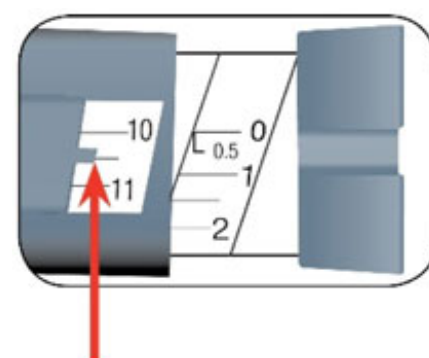

Example: 10.5 (10  $\frac{1}{2}$ ) units shown in the Dose Window

- The Pen will not let you dial more than the number of units left in the Pen.
- If you need to inject more than the number of units left in the Pen, you may either:
  - inject the amount left in your Pen and then use a new Pen to give the rest of your dose, **or**
  - get a new Pen and inject the full dose.
- It is normal to see a small amount of insulin left in the Pen that you can not inject.

## Giving your injection

- Inject your insulin as your healthcare provider has shown you.
- Change (rotate) your injection sites within the area you choose for each dose to reduce your risk of getting lipodystrophy (pits in skin or thickened skin) and localized cutaneous amyloidosis (skin with lumps) at the injection sites.
- **Do not** inject where the skin has pits, is thickened, or has lumps.
- **Do not** inject where the skin is tender, bruised, scaly or hard, or into scars or damaged skin.
- **Do not** try to change your dose while injecting.

### Step 10:

- Choose your injection site.  
HUMALOG is injected under the skin (subcutaneously) of your stomach area, buttocks, upper legs or upper arms.
- Wipe your skin with an alcohol swab, and let your skin dry before you inject your dose.

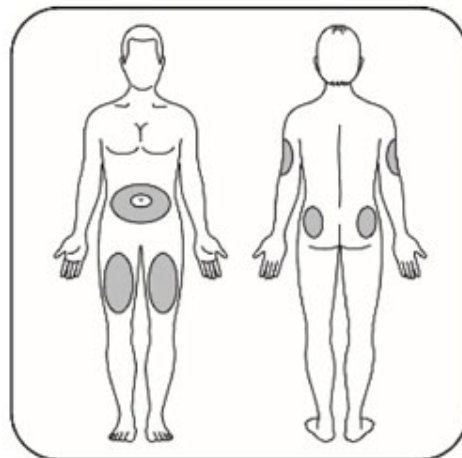

### Step 11:

- Insert the Needle into your skin.
- Push the Dose Knob all the way in.
- Continue to hold the Dose Knob in and **slowly count to 5** before removing the Needle.



**Do not** try to inject your insulin by turning the Dose Knob. You will **not** receive your insulin by turning the Dose Knob.

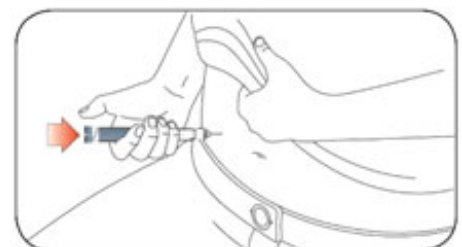

### Step 12:

- Pull the Needle out of your skin.
  - A drop of insulin at the Needle tip is normal. It will not affect your dose.
- Check the number in the Dose Window
  - If you see “0” in the Dose window, you have received the full amount you dialed.
  - If you do not see “0” in the Dose window, **do not** redial. Insert the Needle into your skin and finish your injection.
  - If you **still** do not think you received the full amount you dialed for your injection,

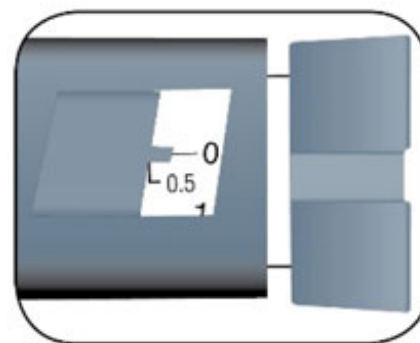



**do not start over or repeat that**

**injection.** Monitor your blood glucose as instructed by your healthcare provider.

- If you normally need to give 2 injections for your full dose, be sure to give your second injection.

The Plunger only moves a little with each injection and you may not notice that it moves.

If you see blood after you take the Needle out of your skin, press the injection site lightly with a piece of gauze or an alcohol swab. **Do not** rub the area.

## After your injection

### Step 13:

- Carefully replace the Outer Needle Shield.

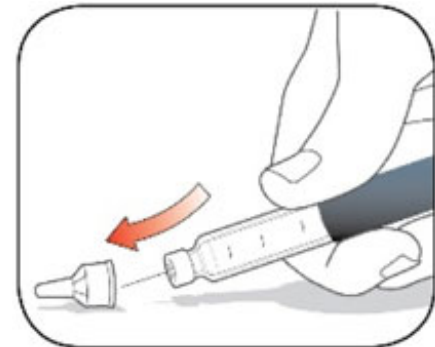

### Step 14:

- Unscrew the capped Needle and throw it away (see **Disposing of Pens and Needles** section).
- Do not store the Pen with the Needle attached to prevent leaking, blocking the Needle, and air from entering the Pen.

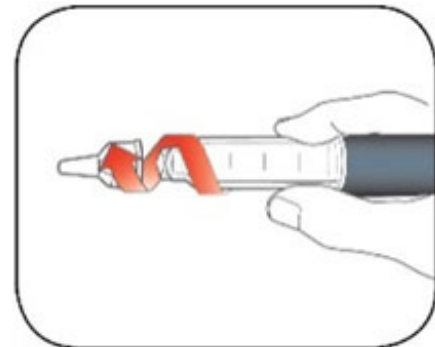

### Step 15:

- Replace the Pen Cap by lining up the Cap Clip with the Dose Indicator and pushing straight on.

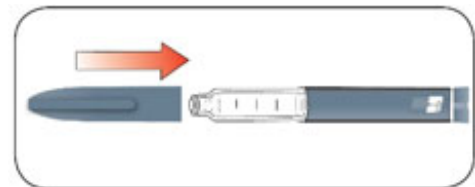

## Disposing of Pens and Needles

- The used Pen may be discarded in your household trash after you have removed the needle.
- Put your used Needles in a FDA-cleared sharps disposal container right away after use. **Do not** throw away (dispose of) loose needles in your household trash.

- If you do not have a FDA-cleared sharps disposal container, you may use a household container that is:
  - made of a heavy-duty plastic,
  - can be closed with a tight-fitting, puncture-resistant lid, without sharps being able to come out,
  - upright and stable during use,
  - leak-resistant, and
  - properly labeled to warn of hazardous waste inside the container.
- When your sharps disposal container is almost full, you will need to follow your community guidelines for the right way to dispose of your sharps disposal container. There may be state or local laws about how you should throw away used needles. For more information about safe sharps disposal, and for specific information about sharps disposal in the state that you live in, go to the FDA's website at: <http://www.fda.gov/safesharpsdisposal>
- Do not dispose of your used sharps disposal container in your household trash unless your community guidelines permit this. Do not recycle the container.

## Storing your Pen

### Unused Pens

- Store unused Pens in the refrigerator at 36°F to 46°F (2°C to 8°C).
- **Do not** freeze your insulin. **Do not** use if it has been frozen.
- Unused Pens may be used until the expiration date printed on the Label, if the Pen has been kept in the refrigerator.

### In-use Pen

- Store the Pen you are currently using at room temperature [up to 86°F (30°C)]. Keep away from heat and light.
- Throw away the HUMALOG Pen you are using after 28 days, even if it still has insulin left in it.

## General information about the safe and effective use of your Pen

- **Keep your Pen and Needles out of the sight and reach of children.**
- **Do not** use your Pen if any part looks broken or damaged.
- Always carry an extra Pen in case yours is lost or damaged.

## Troubleshooting

- If you can not remove the Pen Cap, gently twist the cap back and forth, and then pull the cap straight off.
- If the Dose Knob is hard to push:
  - Pushing the Dose Knob more slowly will make it easier to inject.
  - Your Needle may be blocked. Put on a new Needle and prime the Pen.
  - You may have dust, food, or liquid inside the Pen. Throw the Pen away and get a new Pen.

If you have any questions or problems with your HUMALOG Junior KwikPen, contact Lilly at 1-800-LillyRx (1-800-545-5979) or call your healthcare provider for help. For more information on HUMALOG Junior KwikPen and insulin, go to [www.humalog.com](http://www.humalog.com).

Manufactured by:  
Eli Lilly and Company  
Indianapolis, IN 46285, USA  
US License Number 1891

*This Instructions for Use has been approved by the U.S. Food and Drug Administration.*

Revised: July 2023

Scan this code to launch ([www.humalog.com](http://www.humalog.com))



HUMALOG® and HUMALOG® Junior KwikPen® are trademarks of Eli Lilly and Company.  
Copyright © 2017, 2023, Eli Lilly and Company. All rights reserved.

**HUMALOG Junior KwikPen** meets the current dose accuracy and functional requirements of ISO 11608-1.

LOGJRP-0004-IFU-20230721

## **Tempo Pen U-100 Instructions for Use**

### **INSTRUCTIONS FOR USE**

**HUMALOG® (HU-ma-log) Tempo Pen™**

**(insulin lispro)**

**injection, for subcutaneous use**

**3 mL single-patient-use pen, (100 units per mL)**



Read the Instructions for Use before you start taking HUMALOG and each time you get another HUMALOG Tempo Pen. There may be new information. This information does not take the place of talking to your healthcare provider about your medical condition or your treatment.

**Do not share your HUMALOG Tempo Pen with other people, even if the needle has been changed. You may give other people a serious infection or get a serious infection from them.**

HUMALOG Tempo Pen (“Pen”) is a disposable single-patient-use prefilled pen containing

300 units of HUMALOG. You can give yourself more than 1 dose from the Pen. Each turn (click) of the Dose Knob dials 1 unit of insulin. You can give from 1 to 60 units in a single injection. **If your dose is more than 60 units, you will need to give yourself more than 1 injection.** The Plunger only moves a little with each injection, and you may not notice that it moves. The Plunger will only reach the end of the cartridge when you have used all 300 units in the Pen.

**People who are blind or have vision problems should not use the Pen without help from a person trained to use the Pen.**

This HUMALOG Tempo Pen contains a component that allows for data connectivity when used with a compatible transmitter.

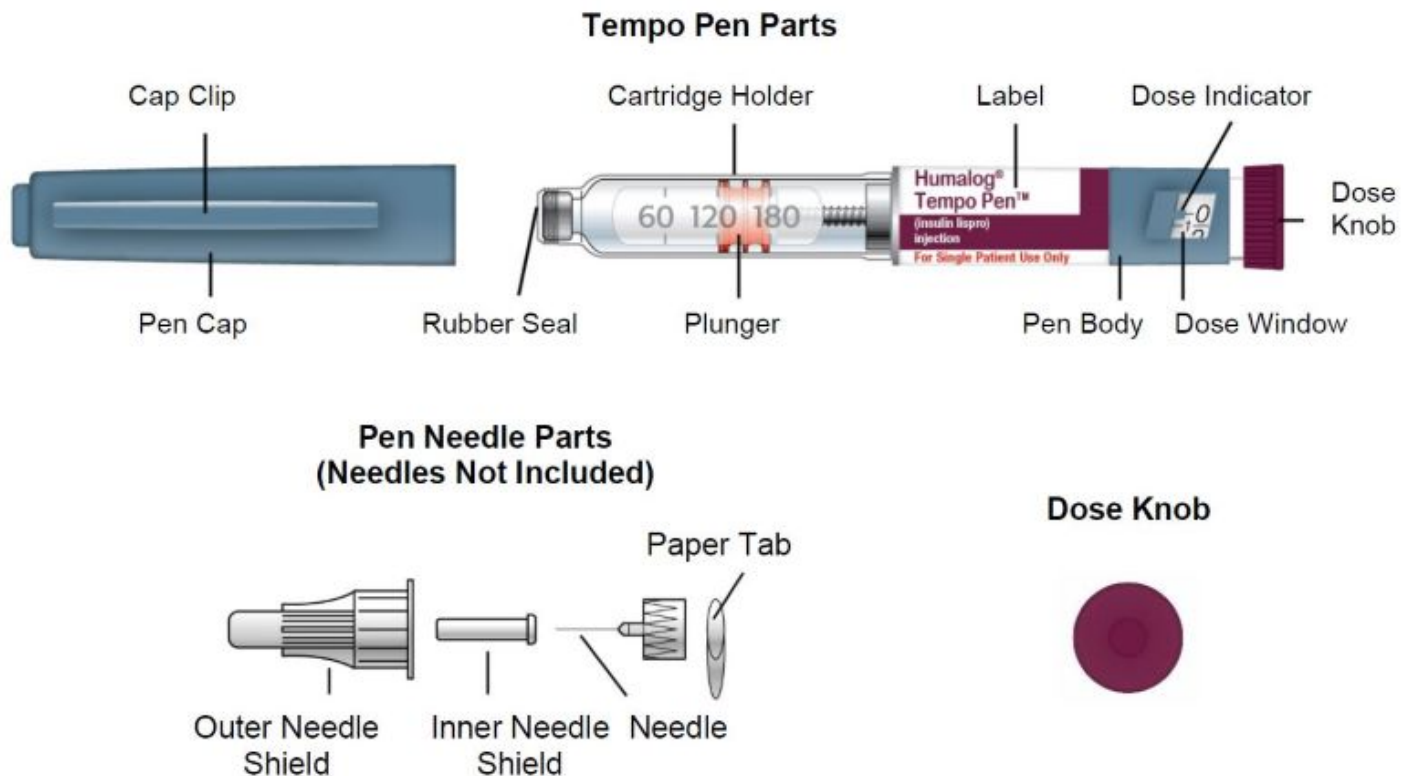

### How to recognize your HUMALOG Tempo Pen

- Pen color: Dark blue
- Dose Knob: Burgundy
- Labels: White label with burgundy stripe

### Supplies you will need to give your injection

- HUMALOG Tempo Pen
- Tempo Pen compatible Needle (Becton, Dickinson and Company Pen Needles recommended)
- Alcohol swab
- Gauze

### Preparing your Pen

- Wash your hands with soap and water.
- Check your Pen to make sure you are taking the right type of insulin. This is especially

important if you use more than 1 type of insulin.

- **Do not** use your Pen past the expiration date printed on the Label or for more than 28 days after you first start using the Pen.
- **Always use a new needle for each injection to help prevent infections and blocked needles. Do not reuse or share your needles with other people. You may give other people a serious infection or get a serious infection from them.**

---

### Step 1:

- Pull the Pen Cap straight off.
  - **Do not** remove the Pen Label.
- Wipe the Rubber Seal with an alcohol swab.

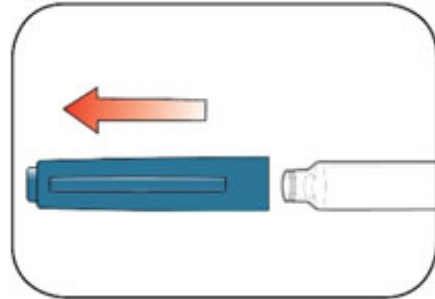

### Step 2:

- **Check the liquid in the Pen.** HUMALOG should look clear and colorless. **Do not** use if it is cloudy, colored, or has particles or clumps in it.

---

### Step 3:

- **Select a new Needle.**
- Pull off the Paper Tab from the Outer Needle Shield.



---

### Step 4:

- Push the capped Needle straight onto the Pen and twist the Needle on until it is tight.

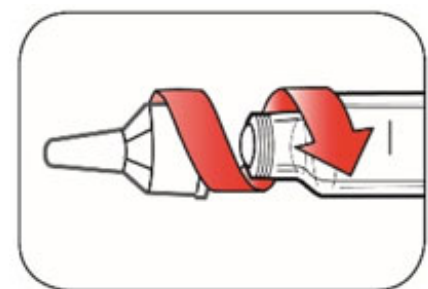

---

### Step 5:

- Pull off the Outer Needle Shield. **Do not** throw it away.
- Pull off the Inner Needle Shield and throw it away.

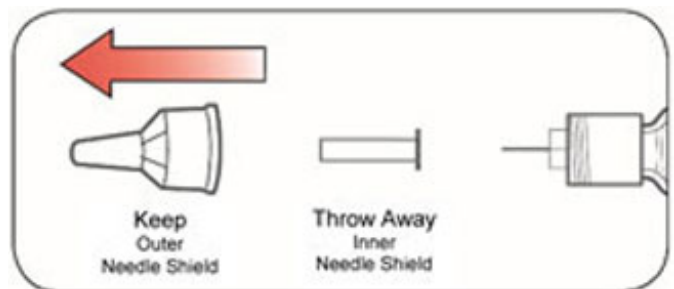

## Priming your Pen

### Prime before each injection.

- Priming your Pen means removing the air from the Needle and Cartridge that may collect during normal use and ensures that the Pen is working correctly.
- If you **do not** prime before each injection, you may get too much or too little insulin.

---

#### Step 6:

- To prime your Pen, turn the Dose Knob to **select 2 units**.



---

#### Step 7:

- Hold your Pen with the Needle pointing up. Tap the Cartridge Holder gently to collect air bubbles at the top.



---

#### Step 8:

- Continue holding your Pen with the Needle pointing up. Push the Dose Knob in until it stops, and "0" is seen in the Dose Window. Hold the Dose Knob in and **count to 5 slowly**.

You should see insulin at the tip of the Needle.

- If you **do not** see insulin, repeat priming steps 6 to 8, but no more than 4 times.
- If you **still do not** see insulin, change the Needle and repeat priming steps 6 to 8.

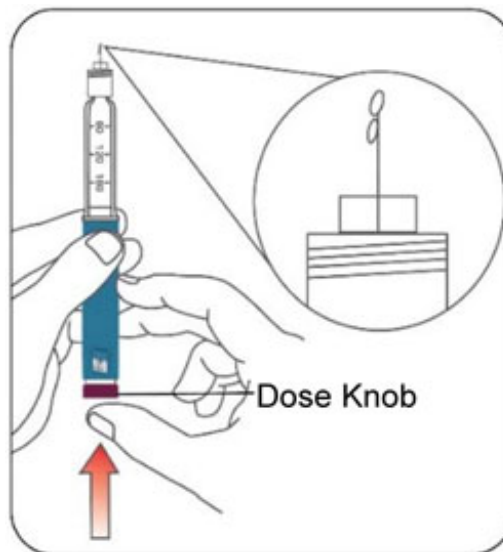

Small air bubbles are normal and will not affect your dose.



## Selecting your dose

- You can give from 1 to 60 units in a single injection.
- If your dose is more than 60 units, you will need to give more than 1 injection.
  - If you need help with dividing up your dose the right way, ask your healthcare provider.
  - Use a new Needle for each injection and repeat the priming step.

---

### Step 9:

- Turn the Dose Knob to select the number of units you need to inject. The Dose Indicator should line up with your dose.
  - The Pen dials 1 unit at a time.
  - The Dose Knob clicks as you turn it.
  - **Do not** dial your dose by counting the clicks. You may dial the wrong dose. This may lead to you getting too much insulin or not enough insulin.
  - The dose can be corrected by turning the Dose Knob in either direction until the correct dose lines up with the Dose Indicator.
  - The **even** numbers (for example, 12) are printed on the dial.
  - The **odd** numbers, (for example, 25) after the number 1, are shown as full lines.

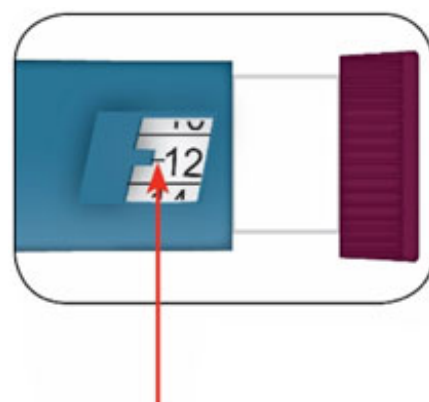
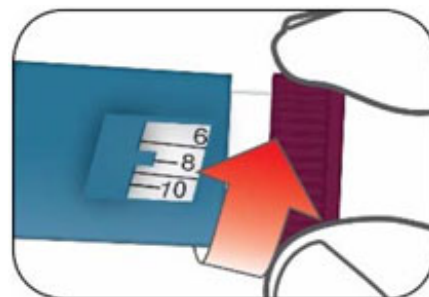

(Example: 12 units shown in the Dose Window)

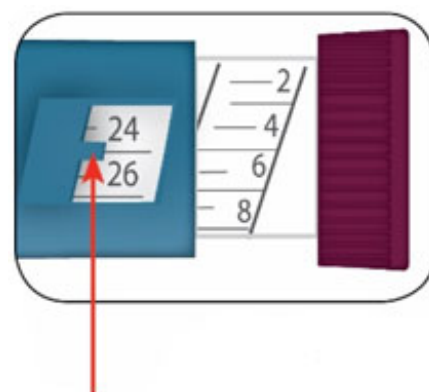

(Example: 25 units shown in the Dose Window)

- 
- The Pen will not let you dial more than the number of units left in the Pen.
  - If you need to inject more than the number of units left in the Pen, you may either:
    - inject the amount left in your Pen and then use a new Pen to give the rest of your dose, **or**

- get a new Pen and inject the full dose.

- It is normal to see a small amount of insulin left in the Pen that you cannot inject.

### Giving your injection

- Inject your insulin as your healthcare provider has shown you.
- Change (rotate) your injection sites within the area you choose for each dose to reduce your risk of getting lipodystrophy (pits in skin or thickened skin) and localized cutaneous amyloidosis (skin with lumps) at the injection sites.
- **Do not** inject where the skin has pits, is thickened, or has lumps.
- **Do not** inject where the skin is tender, bruised, scaly or hard, or into scars or damaged skin.
- **Do not** try to change your dose while injecting.

---

#### Step 10:

- Choose your injection site.  
HUMALOG is injected under the skin (subcutaneously) of your stomach area, buttocks, upper legs or upper arms.
- Wipe your skin with an alcohol swab, and let your skin dry before you inject your dose.

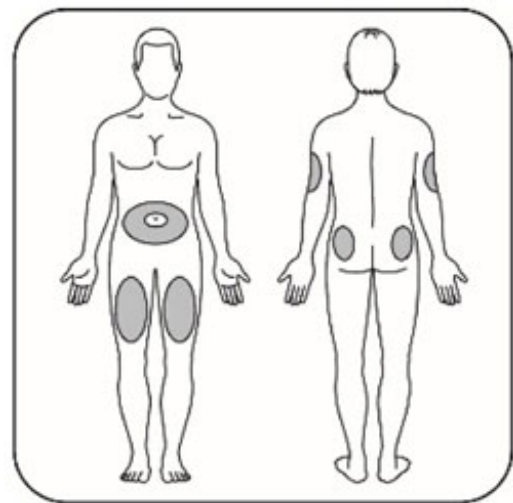

---

#### Step 11:

Insert the Needle into your skin.  
Push the Dose Knob all the way in.  
Continue to hold the Dose Knob in and **slowly count to 5** before removing the Needle.



**Do not** try to inject your insulin by turning the Dose Knob. You will **not** receive your insulin by turning the Dose Knob.

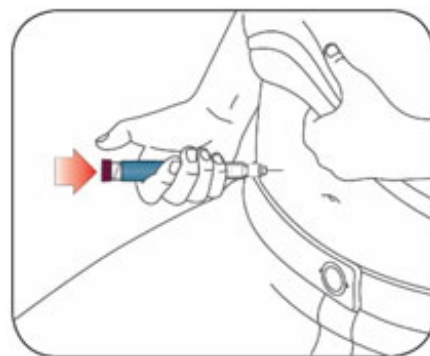

---

#### Step 12:



- Pull the Needle out of your skin.  
A drop of insulin at the Needle tip is normal. It will not affect your dose.
- Check the number in the Dose Window.
  - If you see “0” in the Dose Window, you have received the full amount you dialed.
  - If you do not see “0” in the Dose Window, do not redial. Insert the Needle into your skin and finish your injection.
  - If you **still** do not think you received the full amount you dialed for your injection, **do not start over or repeat the injection.** Monitor your blood sugar (glucose) as instructed by your healthcare provider.
  - If you normally need to give 2 injections for your full dose, be sure to give your second injection.

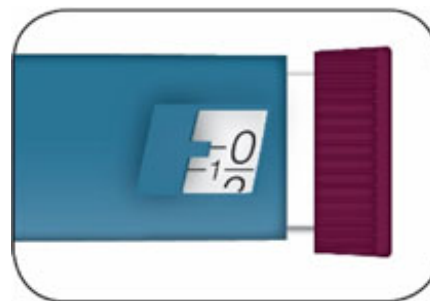

The Plunger only moves a little with each injection, and you may not notice that it moves.

If you see blood after you take the Needle out of your skin, press the injection site lightly with a piece of gauze or an alcohol swab. **Do not** rub the area.

## After your injection

### Step 13:

- Carefully replace the Outer Needle Shield.

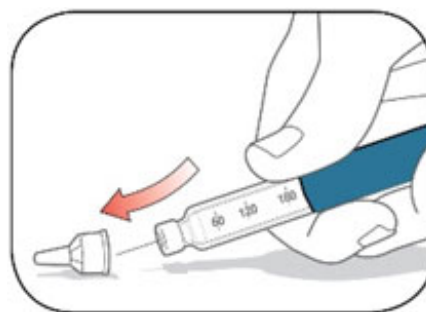

### Step 14:

- Unscrew the capped Needle and throw it away (see **Disposing of Pens and Needles** section).
- **Do not** store the Pen with the Needle attached to prevent leaking, blocking the Needle, and air from entering the Pen.

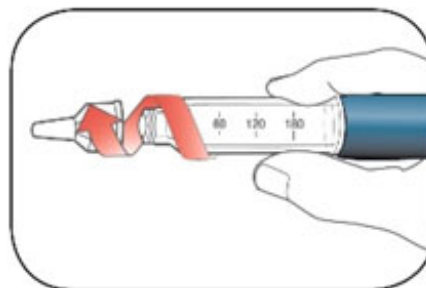

### Step 15:

- Replace the Pen Cap by lining up the Cap Clip with the Dose Indicator and pushing straight on.

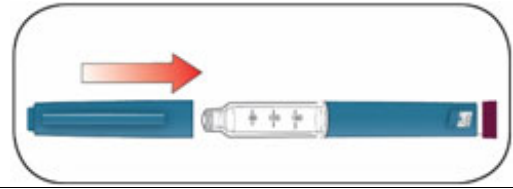

### Disposing of Pens and Needles

- The used Pen may be discarded in your household trash after you have removed the needle.
- Put your used needles in a FDA-cleared sharps disposal container right away after use. Do not throw away (dispose of) loose needles in your household trash.
- If you do not have a FDA-cleared sharps disposal container, you may use a household container that is:
  - made of a heavy-duty plastic,
  - can be closed with a tight-fitting, puncture-resistant lid, without sharps being able to come out,
  - upright and stable during use,
  - leak-resistant, and
  - properly labeled to warn of hazardous waste inside the container.
- When your sharps disposal container is almost full, you will need to follow your community guidelines for the right way to dispose of your sharps disposal container. There may be state or local laws about how you should throw away used needles and syringes. For more information about safe sharps disposal, and for specific information about sharps disposal in the state that you live in, go to the FDA's website at: <http://www.fda.gov/safesharpsdisposal>
- Do not dispose of your used sharps disposal container in your household trash unless your community guidelines permit this. Do not recycle your used sharps disposal container.

### Storing your Pen

#### Unopened Pens

- Store unopened Pens in the refrigerator at 36°F to 46°F (2°C to 8°C).
- **Do not** freeze your insulin. **Do not** use if it has been frozen.
- Unopened Pens may be used until the expiration date printed on the Label, if the Pen has been kept in the refrigerator.

#### In-use Pen

- Store the Pen you are currently using at room temperature [up to 86°F (30°C)]. Keep away from heat and light.
- Throw away the HUMALOG Tempo Pen you are using after 28 days, even if it still has insulin left in it.

### General information about the safe and effective use of your Pen

- **Keep your Pen and needles out of the reach of children.**
- **Do not** use your Pen if any part looks broken or damaged.
- Always carry an extra Pen in case yours is lost or damaged.

## Troubleshooting

- If you cannot remove the Pen Cap, gently twist the cap back and forth, and then pull the cap straight off.
- If the Dose Knob is hard to push:
  - Pushing the Dose Knob more slowly will make it easier to inject.
  - Your Needle may be blocked. Put on a new Needle and prime the Pen.
  - You may have dust, food, or liquid inside the Pen. Throw the Pen away and get a new Pen.

If you have any questions or problems with your HUMALOG Tempo Pen, contact Lilly at 1-800-LillyRx (1-800-545-5979) or call your healthcare provider for help. For more information on HUMALOG Tempo Pen and insulin, go to [www.humalog.com](http://www.humalog.com).

Manufactured by:  
Eli Lilly and Company  
Indianapolis, IN 46285, USA  
US License Number 1891

This Instructions for Use has been approved by the U.S. Food and Drug Administration.

Revised: July 2023

Scan this code to launch ([www.humalog.com](http://www.humalog.com))



HUMALOG<sup>®</sup> is a registered trademark and TEMPO PEN<sup>™</sup> is a trademark of Eli Lilly and Company.

Copyright © 2019, 2023, Eli Lilly and Company. All rights reserved.

**HUMALOG Tempo Pen** meets the current dose accuracy and functional requirements of ISO 11608-1.

LOGTP-0002-IFU-20230721

## U-200 Patient Package Insert

**PATIENT INFORMATION**  
**HUMALOG<sup>®</sup> (HU-ma-log) KwikPen<sup>®</sup>**  
**(insulin lispro)**  
**injection, for subcutaneous use**  
**200 units per mL**

**Do not share your HUMALOG KwikPen or needles with other people, even if the needle has been changed. You may give other people a serious infection, or get a serious infection from them.**

**What is HUMALOG?**

- HUMALOG is a rapid-acting man-made insulin used to control high blood sugar in adults and children with diabetes mellitus.
- This single-patient-use HUMALOG U-200 KwikPen (“Pen”) contains **2** times as much insulin (200 units per mL) in 1 mL as HUMALOG U-100 KwikPen (100 units per mL).

### **Who should not take HUMALOG?**

#### **Do not take HUMALOG if you:**

- are having an episode of low blood sugar (hypoglycemia).
- have an allergy to insulin lispro or any of the ingredients in HUMALOG. See the end of this Patient Information leaflet for a complete list of ingredients in HUMALOG.

### **What should I tell my healthcare provider before taking HUMALOG?**

#### **Before taking HUMALOG, tell your healthcare provider about all your medical conditions, including if you:**

- have liver or kidney problems.
- take any other medicines, especially ones called TZDs (thiazolidinediones).
- have heart failure or other heart problems. If you have heart failure, it may get worse while you take TZDs with HUMALOG.
- are pregnant or plan to become pregnant. Talk to your healthcare provider about the best way to control your blood sugar if you plan to become pregnant or while you are pregnant.
- are breastfeeding or plan to breastfeed. Talk with your healthcare provider about the best way to feed your baby while taking HUMALOG.

**Tell your healthcare provider about all the medicines you take**, including prescription and over-the-counter medicines, vitamins, and herbal supplements.

**Before you start taking HUMALOG, talk to your healthcare provider about low blood sugar and how to manage it.**

### **How should I use HUMALOG KwikPen?**

- Read the detailed **Instructions for Use** that comes with your HUMALOG KwikPen.
- Use HUMALOG KwikPen exactly as your healthcare provider tells you to. Your healthcare provider should tell you how much HUMALOG to take and when to take it.
- Know the type, strength and amount of insulin you take. **Do not** change the type or amount of insulin you take unless your healthcare provider tells you to. The amount of insulin and the best time for you to take your insulin may need to change if you take different types of insulin.
- Check your insulin label each time you give your injection to make sure you are taking the correct insulin.
- HUMALOG comes in a KwikPen which is a disposable single-patient-use prefilled pen that you must use to give your HUMALOG. The dose window on your pen shows your dose of HUMALOG. **Do not** make any dose changes unless your healthcare provider tells you to.
- **Do not** use a syringe to remove HUMALOG from your KwikPen disposable prefilled pen.
- **Do not** re-use needles. Always use a new needle for each injection. Re-use of needles increases your risk of having blocked needles, which may cause you to get the wrong dose of HUMALOG. Using a new needle for each injection also lowers your risk of getting an infection. If your needle is blocked, follow the instructions in the **“General information about the safe and effective use of your Pen”**

section of the Instructions for Use.

- **HUMALOG is a rapid-acting insulin. Inject HUMALOG within 15 minutes before or right after eating a meal.**
- Inject HUMALOG under the skin (subcutaneously) of your stomach area, buttocks, upper legs or upper arms. **Do not** use HUMALOG KwikPen (“Pen”) in an insulin pump or inject HUMALOG KwikPen into your vein (intravenously).
- **Change (rotate) your injection sites within the area you choose with each dose** to reduce your risk of getting lipodystrophy (pits in skin or thickened skin) and localized cutaneous amyloidosis (skin with lumps) at the injection sites.
  - **Do not** use the exact same spot for each injection.
  - **Do not** inject where the skin has pits, is thickened, or has lumps.
  - **Do not** inject where the skin is tender, bruised, scaly or hard, or into scars or damaged skin.
- **Do not** mix the HUMALOG in the HUMALOG KwikPen with any other type of insulin or liquid medicine.
- **Check your blood sugar levels.** Ask your healthcare provider what your blood sugar should be and when you should check your blood sugar levels.

**Keep HUMALOG KwikPen and all medicines out of reach of children.**

**Your dose of HUMALOG may need to change because of a:**

- change in physical activity or exercise, weight gain or loss, increased stress, illness, change in diet, or because of other medicines you take.

**What should I avoid while using HUMALOG KwikPen?**

**While using HUMALOG KwikPen do not:**

- drive or operate heavy machinery, until you know how HUMALOG KwikPen affects you
- drink alcohol or take prescription or over-the-counter medicines that contain alcohol

**What are the possible side effects of HUMALOG?**

**HUMALOG may cause serious side effects that can lead to death, including:**

- **low blood sugar (hypoglycemia).** Signs and symptoms of low blood sugar may include:
  - dizziness or light-headedness
  - sweating
  - confusion
  - headache
  - blurred vision
  - slurred speech
  - shakiness
  - fast heartbeat
  - anxiety, irritability or mood changes
  - hunger

Your healthcare provider may prescribe a glucagon product for emergency use so that someone else can give you glucagon if your blood sugar becomes too low (severe hypoglycemia) and you are unable to take sugar by mouth.

- **severe allergic reaction (whole body reaction). Get medical help right away, if you have any of these signs or symptoms of a severe allergic reaction:**

- a rash over your whole body
- a fast heartbeat
- trouble breathing
- sweating

- **low potassium in your blood (hypokalemia).**
- **heart failure.** Taking certain diabetes pills called thiazolidinediones or “TZDs” with HUMALOG may cause heart failure in some people. This can happen even if you have never had heart failure or heart problems before. If you already have heart failure it may get worse while you take TZDs with HUMALOG. Your healthcare provider should monitor you closely while you are taking TZDs with HUMALOG. Tell your healthcare provider if you have any new or worse symptoms of heart failure including:
  - shortness of breath
  - swelling of your ankles or feet
  - sudden weight gain

Treatment with TZDs and HUMALOG may need to be adjusted or stopped by your healthcare provider if you have new or worse heart failure.

**Get emergency medical help if you have:**

- trouble breathing
- shortness of breath
- fast heartbeat
- swelling of your face, tongue, or throat
- sweating
- extreme drowsiness
- dizziness
- confusion

**The most common side effects of HUMALOG include:**

- low blood sugar (hypoglycemia)
- reactions at your injection site
- skin thickening or pits at the injection site (lipodystrophy)
- weight gain
- swelling in your hands or feet
- itching
- rash

**These are not all of the possible side effects of HUMALOG.** Call your doctor for medical advice about side effects. You may report side effects to FDA at 1-800-FDA-1088.

**General Information about the safe and effective use of HUMALOG KwikPen.**

Medicines are sometimes prescribed for purposes other than those listed in a Patient Information leaflet. Do not take HUMALOG for a condition for which it was not prescribed. Do not give HUMALOG to other people, even if they have the same symptoms that you have. It may harm them.

This Patient Information leaflet summarizes the most important information about HUMALOG KwikPen. If you would like more information, talk with your healthcare provider. You can ask your pharmacist or healthcare provider for information about HUMALOG that is written for healthcare professionals.

**What are the ingredients in HUMALOG U-200?**

**Active ingredient:** insulin lispro.

**Inactive ingredient:** glycerin, metacresol, trace amounts of phenol, tromethamine, zinc oxide (zinc ion), and Water for Injection, USP.

Humalog® and Humalog KwikPen® are registered trademarks of Eli Lilly and Company. Manufactured by: Eli Lilly and Company, Indianapolis, IN 46285, USA, US License Number 1891

Copyright © 2015, 2023, Eli Lilly and Company. All rights reserved.

For more information, go to [www.humalog.com](http://www.humalog.com) or call 1-800-545-5979.

## **KwikPen U-200 Instructions for Use**

### **INSTRUCTIONS FOR USE**

#### **HUMALOG (HU-ma-log) KwikPen®**

**(insulin lispro)**

**injection, for subcutaneous use**

**3 mL single-patient-use pen (200 units per mL)**



**DO NOT TRANSFER TO A SYRINGE  
SEVERE OVERDOSE CAN RESULT**

Read the Instructions for Use before you start taking HUMALOG® and each time you get another KwikPen®. There may be new information. This information does not take the place of talking to your healthcare provider about your medical condition or your treatment.

**Do not share your HUMALOG KwikPen with other people, even if the needle has been changed. You may give other people a serious infection or get a serious infection from them.**

HUMALOG KwikPen 200 units/mL ("Pen") is a disposable single-patient-use prefilled pen containing 600 units of HUMALOG. You can give yourself more than 1 dose from the Pen. Each turn (click) of the Dose Knob dials 1 unit of insulin. You can give from 1 to 60 units in a single injection. **If your dose is more than 60 units, you will need to give yourself more than 1 injection.** The Plunger only moves a little with each injection, and you may not notice that it moves. The Plunger will only reach the end of the cartridge when you have used all 600 units in the Pen.

**Inject HUMALOG 200 units/mL only with your Pen. Do not transfer insulin from your Pen to a syringe. Syringes will not measure 200 units/mL insulin correctly. A severe overdose can result, causing very low blood sugar which may put your life in danger.**

**People who are blind or have vision problems should not use the Pen without help from a person trained to use the Pen.**

## KwikPen Parts

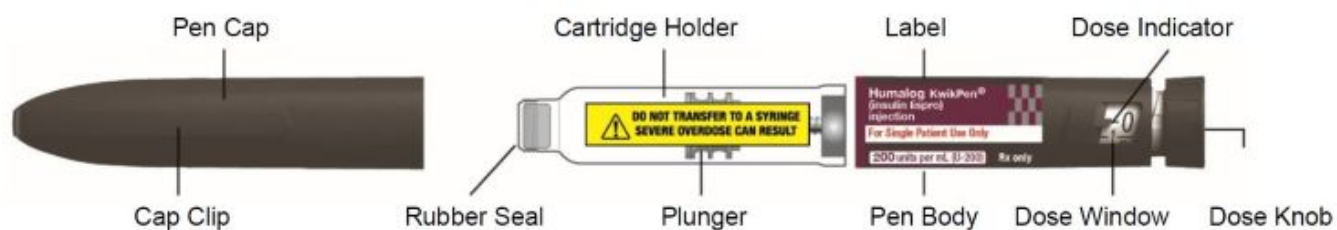

## Pen Needle Parts (Needles Not Included)

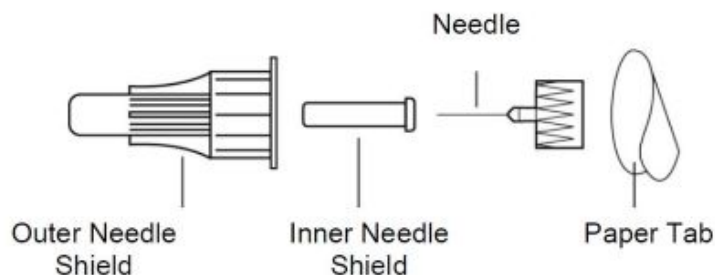

## Dose Knob



## How to recognize your HUMALOG 200 units/mL KwikPen

- Pen color: Dark grey
- Dose Knob: Dark grey with burgundy ring on the end
- Label: Burgundy label with "200 units per mL (U-200)" in white stripe and a grey and burgundy checker board design.

## Supplies needed to give your injection

- HUMALOG KwikPen
- KwikPen compatible Needle (Becton, Dickinson and Company Pen Needles recommended)
- Alcohol swab
- Gauze

## Preparing your Pen

- Wash your hands with soap and water.
- Check your Pen to make sure you are taking the right type of insulin. This is especially important if you use more than 1 type of insulin.
- **Do not** use your Pen past the expiration date printed on the Label or for more than 28 days after you first start using the Pen.
- **Always use a new needle for each injection to help prevent infections and blocked needles. Do not reuse or share your needles with other people. You may give other people a serious infection or get a serious infection from them.**

---

## Step 1:



- Pull the Pen Cap straight off.
  - **Do not** remove the Pen Label.
- Wipe the Rubber Seal with an alcohol swab.

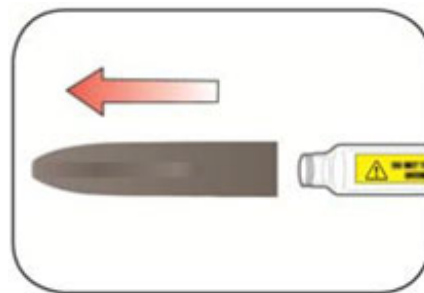

### Step 2:

- **Check the liquid in the Pen.**  
HUMALOG should look clear and colorless. **Do not** use if it is cloudy, colored, or has particles or clumps in it.

---

### Step 3:

- Select a new Needle.
- Pull off the Paper Tab from the Outer Needle Shield.

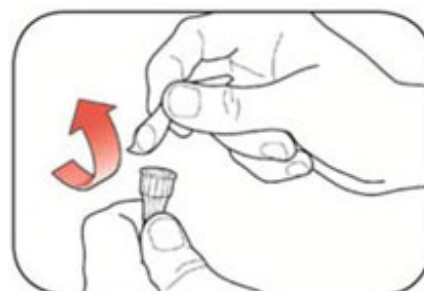

---

### Step 4:

- Push the capped Needle straight onto the Pen and twist the Needle on until it is tight.

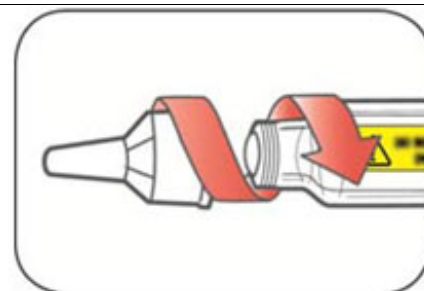

---

### Step 5:

- Pull off the Outer Needle Shield. **Do not** throw it away.
- Pull off the Inner Needle Shield and throw it away.

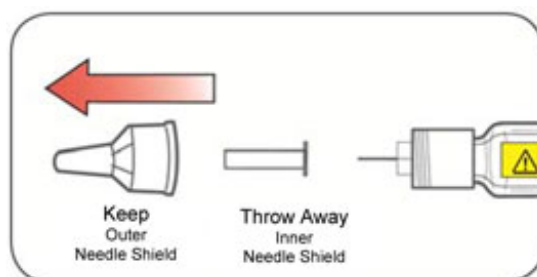

---

## Priming your Pen

### Prime before each injection.

- Priming your Pen means removing the air from the Needle and Cartridge that may collect during normal use and ensures that the Pen is working correctly.
- If you **do not** prime before each injection, you may get too much or too little insulin.

---

### Step 6:

- To prime your Pen, turn the Dose Knob to **select 2 units**.

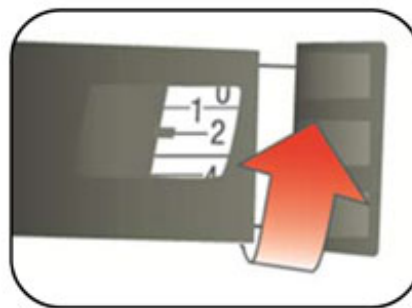

---

### Step 7:

- Hold your Pen with the Needle pointing up. Tap the Cartridge Holder gently to collect air bubbles at the top.



---

### Step 8:

- Continue holding your Pen with Needle pointing up. Push the Dose Knob in until it stops, and “0” is seen in the Dose Window. Hold the Dose Knob in and **count to 5 slowly**.

You should see insulin at the tip of the Needle.

- If you **do not** see insulin, repeat priming steps 6 to 8, no more than 8 times.
- If you **still do not** see insulin, change the Needle and repeat priming steps 6 to 8.

Small air bubbles are normal and will not affect your dose.

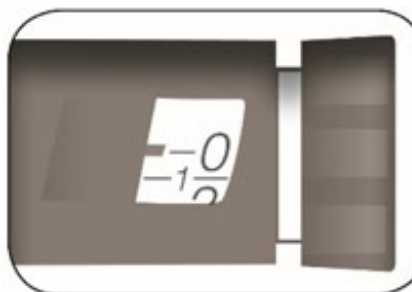
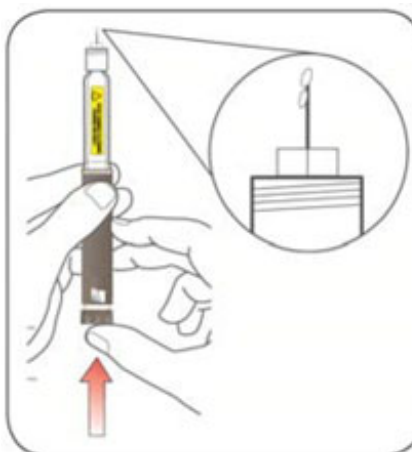

---

## Selecting your dose

**This Pen has been made to deliver the dose that is shown in the Dose Window. Dial your usual dose as instructed by your healthcare provider.**

- You can give from 1 to 60 units in a single injection.
- If your dose is more than 60 units, you will need to give more than 1 injection.
  - If you need help with dividing up your dose the right way, ask your healthcare provider.
  - Use a new Needle for each injection and repeat the priming step.

---

## Step 9:

- Turn the Dose Knob to select the number of units you need to inject. The Dose Indicator should line up with your dose.
  - The Pen dials 1 unit at a time.
  - The Dose Knob clicks as you turn it.
  - **Do not** dial your dose by counting the clicks. You may dial the wrong dose. This may lead to you getting too much insulin or not enough insulin.
  - The dose can be corrected by turning the Dose Knob in either direction until the correct dose lines up with the Dose Indicator.
  - The **even** numbers (for example, 12) are printed on the dial.
  - The **odd** numbers, (for example, 25) after the number 1, are shown as full lines.

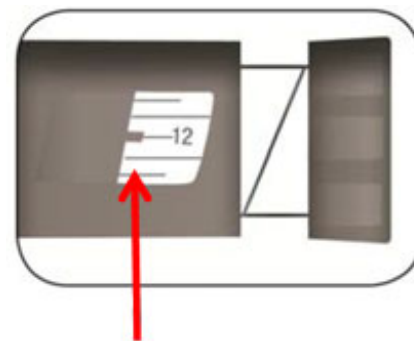
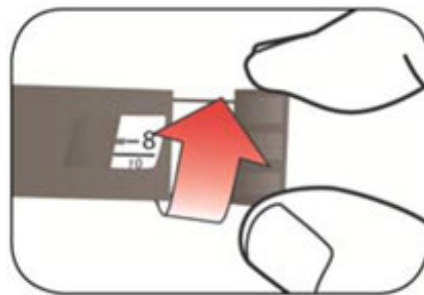

(Example: 12 units shown in the Dose Window)

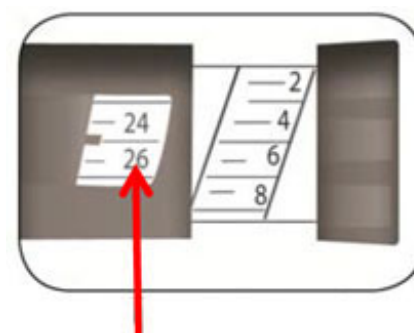

(Example: 25 units shown in the Dose Window)

- 
- The Pen will not let you dial more than the number of units left in the Pen.
  - If you need to inject more than the number of units left in the Pen, you may either:
    - inject the amount left in your Pen and then use a new Pen to give the rest of your dose,  
**or**
    - get a new Pen and inject the full dose.
  - It is normal to see a small amount of insulin left in the Pen that you can not inject. **Do not transfer this to a syringe. Severe overdose can result.**

## Giving your injection

- Inject your insulin as your healthcare provider has shown you.
- Change (rotate) your injection sites within the area you choose for each dose to reduce your risk of getting lipodystrophy (pits in skin or thickened skin) and localized cutaneous amyloidosis (skin with lumps) at the injection sites.

- **Do not** use the exact same spot for each injection.
- **Do not** inject where the skin has pits, is thickened, or has lumps.
- **Do not** inject where the skin is tender, bruised, scaly or hard, or into scars or damaged skin.
- **Do not** try to change your dose while injecting.

### Step 10:

- Choose your injection site.  
HUMALOG is injected under the skin (subcutaneously) of your stomach area, buttocks, upper legs or upper arms.
- Wipe your skin with an alcohol swab, and let your skin dry before you inject your dose.

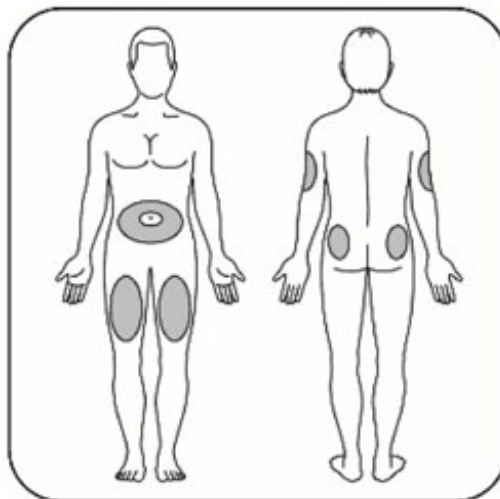

### Step 11:

- Insert the Needle into your skin.
- Push the Dose Knob all the way in.
- Continue to hold the Dose Knob in and **slowly count to 5** before removing the Needle.

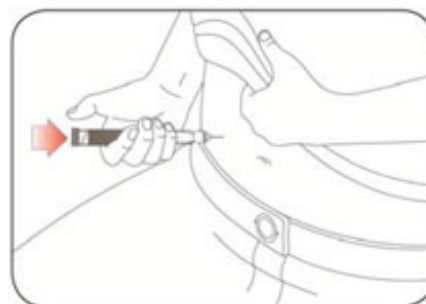

**Do not** try to inject your insulin by turning the Dose Knob. You will **not** receive your insulin by turning the Dose Knob.

### Step 12:

- Pull the Needle out of your skin.
  - A drop of insulin at the Needle tip is normal. It will not affect your dose.
- Check the number in the Dose Window
  - If you see "0" in the Dose Window, you have received the full amount you dialed.
  - If you do not see "0" in the Dose Window, **do not** redial. Insert the Needle into your skin and finish your injection.
  - If you **still** do not think you received the full amount you dialed

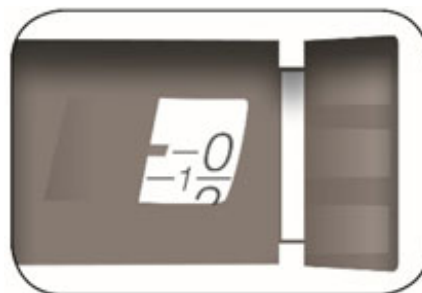

for your injection, **do not start over or repeat the injection.**

Monitor your blood glucose as instructed by your healthcare provider.

- If you normally need to give 2 injections for your full dose, be sure to give your second injection.

The Plunger only moves a little with each injection, and you may not notice that it moves.

If you see blood after you take the Needle out of your skin, press the injection site lightly with a piece of gauze or an alcohol swab. **Do not** rub the area.

---

## After your injection

---

### Step 13:

- Carefully replace the Outer Needle Shield.



### Step 14:

- Unscrew the capped Needle and throw it away (see **Disposing of Pens and Needles** section).
- **Do not** store the Pen with the Needle attached to prevent leaking, blocking the Needle, and air from entering the Pen.

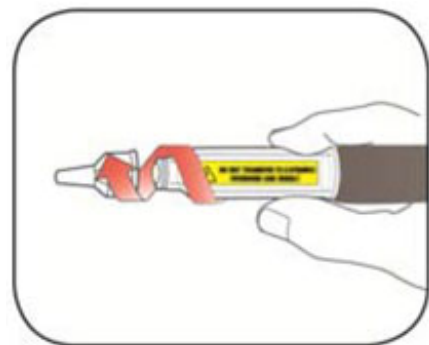

### Step 15:

- Replace the Pen Cap by lining up the Cap Clip with the Dose Indicator and pushing straight on.

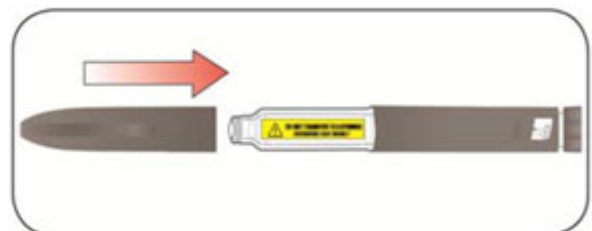

## Disposing of Pens and Needles

- The used Pen may be discarded in your household trash after you have removed the needle.
- Put your used needles in a FDA-cleared sharps disposal container right away after use. **Do not** throw away (dispose of) loose needles in your household trash.
- If you do not have a FDA-cleared sharps disposal container, you may use a household container that is:
  - made of a heavy-duty plastic,
  - can be closed with a tight-fitting, puncture-resistant lid, without sharps being able to come out,
  - upright and stable during use,
  - leak-resistant, and
  - properly labeled to warn of hazardous waste inside the container.
- When your sharps disposal container is almost full, you will need to follow your community guidelines for the right way to dispose of your sharps disposal container. There may be state or local laws about how you should throw away used needles and syringes. For more information about safe sharps disposal, and for specific information about sharps disposal in the state that you live in, go to the FDA's website at: <http://www.fda.gov/safesharpsdisposal>
- Do not dispose of your used sharps disposal container in your household trash unless your community guidelines permit this. Do not recycle your used sharps disposal container.

## Storing your Pen

### Unused Pens

- Store unused Pens in the refrigerator at 36°F to 46°F (2°C to 8°C).
- **Do not** freeze your insulin. **Do not** use if it has been frozen.
- Unused Pens may be used until the expiration date printed on the Label, if the Pen has been kept in the refrigerator.

### In-use Pen

- Store the Pen you are currently using at room temperature [up to 86°F (30°C)]. Keep away from heat and light.
- Throw away the HUMALOG Pen you are using after 28 days, even if it still has insulin left in it.

## General information about the safe and effective use of your Pen

- **Keep your Pen and needles out of the sight and reach of children.**
- **Do not** use your Pen if any part looks broken or damaged.
- Always carry an extra Pen in case yours is lost or damaged.

## Troubleshooting

- If you can not remove the Pen Cap, gently twist the cap back and forth, and then pull the cap straight off.
- If the Dose Knob is hard to push:
  - Pushing the Dose Knob more slowly will make it easier to inject.
  - Your Needle may be blocked. Put on a new Needle and prime the Pen.
  - You may have dust, food, or liquid inside the Pen. Throw the Pen away and get a

new Pen.

If you have any questions or problems with your HUMALOG KwikPen, contact Lilly at 1-800-LillyRx (1-800-545-5979) or call your healthcare provider for help. For more information on HUMALOG KwikPen and insulin, go to [www.humalog.com](http://www.humalog.com).

Manufactured by:  
Eli Lilly and Company  
Indianapolis, IN 46285, USA  
US License Number 1891

*This Instructions for Use has been approved by the U.S. Food and Drug Administration.*

Revised: July 2023



Scan this code to launch ([www.humalog.com](http://www.humalog.com))

HUMALOG® and HUMALOG KwikPen® are trademarks of Eli Lilly and Company.

Copyright © 2015, 2023, Eli Lilly and Company. All rights reserved.

**HUMALOG KwikPen** meets the current dose accuracy and functional requirements of ISO 11608-1.

LOGKP200-0005-IFU-20230721

## Insulin lispro



## HUMALOG

insulin lispro injection, solution

Product Information				
<b>Product Type</b>	HUMAN PRESCRIPTION DRUG	<b>Item Code (Source)</b>	NDC:50090-4488(NDC:0002-7510)	
<b>Route of Administration</b>	INTRAVENOUS, SUBCUTANEOUS			
Active Ingredient/Active Moiety				
Ingredient Name		Basis of Strength	Strength	
INSULIN LISPRO (UNII: GFX7QIS1II) (INSULIN LISPRO - UNII:GFX7QIS1II)		INSULIN LISPRO	100 [iU] in 1 mL	
Inactive Ingredients				
Ingredient Name			Strength	
Glycerin (UNII: PDC6A3C00X)			16 mg in 1 mL	
Sodium Phosphate, Dibasic, Unspecified Form (UNII: GR686LBA74)			1.88 mg in 1 mL	
Metacresol (UNII: GGO4Y809LO)			3.15 mg in 1 mL	
Zinc (UNII: J41CSQ7QDS)			.0197 mg in 1 mL	
Phenol (UNII: 339NCG44TV)				
Water (UNII: 059QF0KO0R)				
Hydrochloric acid (UNII: QTT17582CB)				
Sodium hydroxide (UNII: 55X04QC32I)				
Packaging				
#	Item Code	Package Description	Marketing Start Date	Marketing End Date
1	NDC:50090-4488-0	1 in 1 CARTON	08/29/2019	
1		10 mL in 1 VIAL; Type 0: Not a Combination Product		
Marketing Information				
Marketing Category	Application Number or Monograph Citation	Marketing Start Date	Marketing End Date	
BLA	BLA020563	06/14/1996		

**Labeler** - A-S Medication Solutions (830016429)

## Establishment

Name	Address	ID/FEI	Business Operations
A-S Medication Solutions		830016429	RELABEL(50090-4488)