

SHIERJIE DISINFECTING SOFT WIPES ANTIBACTERIAL- shierjie disinfecting soft wipes antibacterial cloth

Shenzhen Shierjie Biological Engineering Co., LTD

Disclaimer: Most OTC drugs are not reviewed and approved by FDA, however they may be marketed if they comply with applicable regulations and policies. FDA has not evaluated whether this product complies.

43116-026

SHIERJIE DISINFECTING SOFT WIPES Antibacterial

Active Ingredient

Benzalkonium Chloride 0.09%

Dodecyl Dimethyl Ammonium Chloride 0.04 %

Purpose

Antimicrobial

Decreases bacteria on skin

Warnings

For external use only.Keep away from heat or flame.

If you are allergic to any of the ingredients.If children less than 2 months of age.

When using this produc, do not get into eyes.If contact occurs, rinse thoroughly with water.

Stop use and ask a doctor if iri tation or rash develops and continues for more than 72 hours.

If swallowed,get medical help or contact a Poison Control Center right away.

Directions

Adults and children 2 years and over

Apply to hands

Allow to dry without wiping

Children under 2 years

Ask a doctor before use

Other information

/

Inactive ingredients

Aloe Barbadensis Extract , Glycerin , Aqua , Non-woven

Package Label - Principal Display Panel

43116-004-01 1P

CMYK

专色PANTONE号

CMYK



PANTONE



PANTONE
21-1-7 C



PANTONE
68-1-7 C



PANTONE
103-1-1 C

抑菌1片装

125mm

11

34

68

34

1

<p>Hygienic License Number: Yue Wei Xiao Zheng Zi(2019)-02-No.9202 Hygienic Standard: GB15979 Executive Standard: GB/T 27728 Validity date: 2 years Production Date: Show in the page Production location: Shenzhen, Guangdong Production company: Shenzhen Shierjie Biological Engineering Co., LTD Address: 5-1, Tuyang Second Industrial Area, Kuyong Street, Dapeng New District, Shenzhen, China Tel: +86 755 82024582 Postcode: 518000 Web: www.szshierjie.com</p>	   <p>Made in China</p> <p>NDC: 43116-004-01</p>  <p>6 924053 766307</p>
--	--

SHIERJIE[®]
DISINFECTING
SOFT WIPES
Antibacterial
KILLS 99.9% OF GERMS

1 pcs
15cmx18cm
Non-woven Towel

Drug Facts		Keep out of reach of children: If swallowed, get medical help or contact a Poison Control Center right away.	
Active ingredient	Purpose		
Benzalkonium Chloride 0.09%.....	Antiseptic		
Dodecyl Dimethyl Ammonium Chloride 0.04%.....	Antiseptic		
USE Decreases bacteria on skin		Directions	
Warning: For external use only. Keep away from heat or flame.		Adults and children 2 years and over	<input type="checkbox"/> Apply to hands <input type="checkbox"/> Allow to dry without wiping
Do not use: If you are allergic to any of the ingredients. If children less than 2 months of age.		Children under 2 years	Ask a doctor before use
WHEN USING SECTION: When using this product, do not get into eyes. If contact occurs, rinse thoroughly with water.		Inactive ingredients	
STOP USE SECTION: Stop use and ask a doctor if irritation or rash develops and continues for more than 72 hours.		Aloe Barbardensis Extract, Glycerin, Aqua, Non-Woven	

43116-004-02 10P

10片抽抑菌湿巾

135

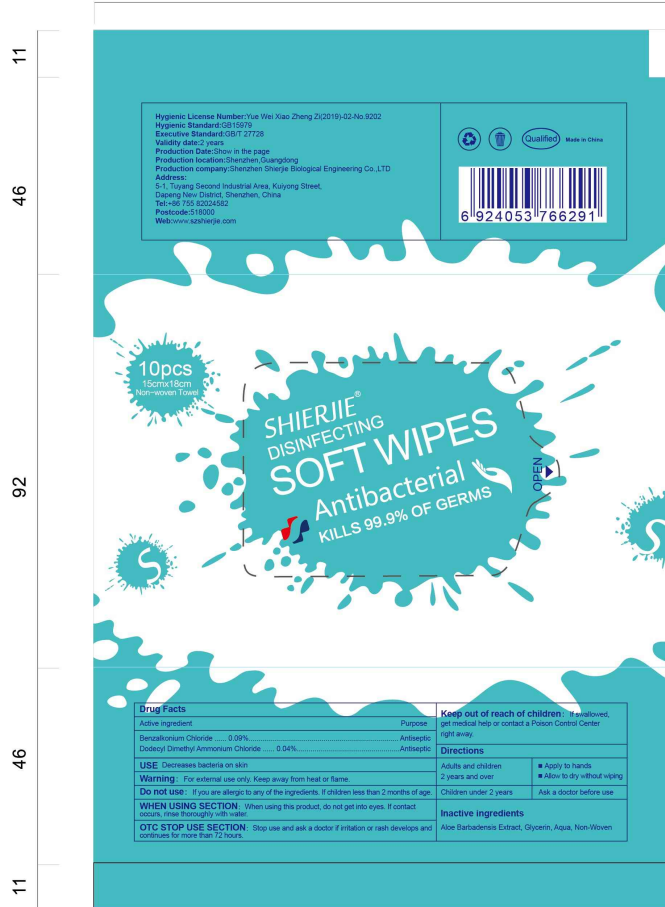

CMYK



专色PANTONE号



PANTONE 21-1-7 C



PANTONE 68-1-7 C



PANTONE 103-1-1 C

10片装透明拉贴

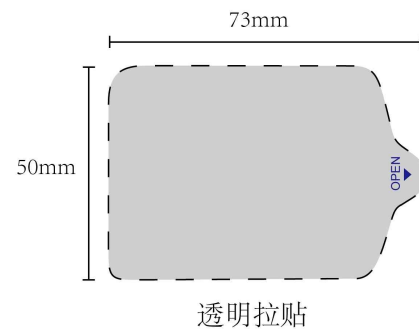

43116-004-03 40P

40片抽抑菌湿巾

135

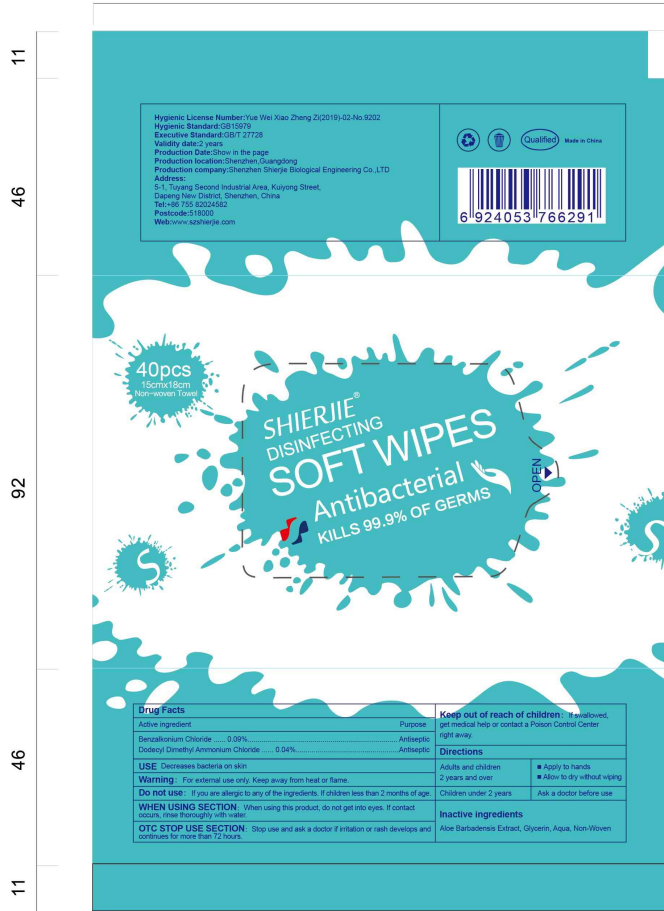

CMYK



专色PANTONE号



40片抽抑菌湿巾

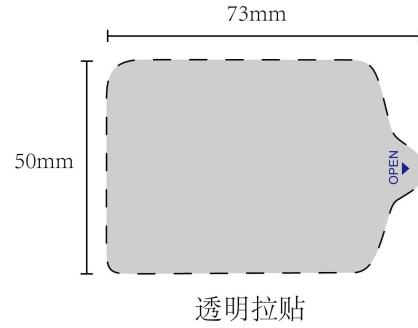

43116-004-04 50P

50片抽抑菌湿巾

135

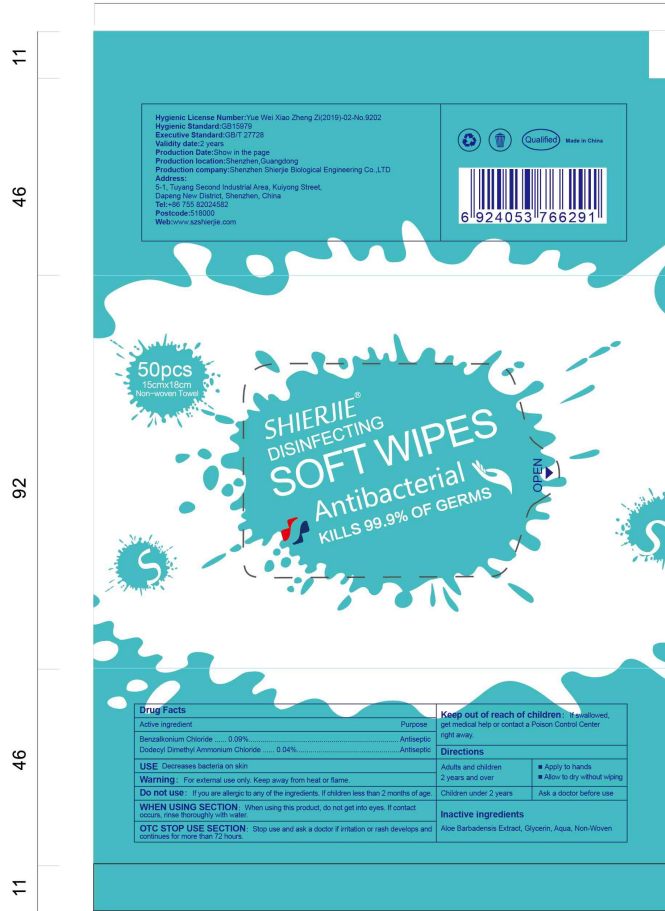

CMYK



专色PANTONE号



50片抽抑菌湿巾

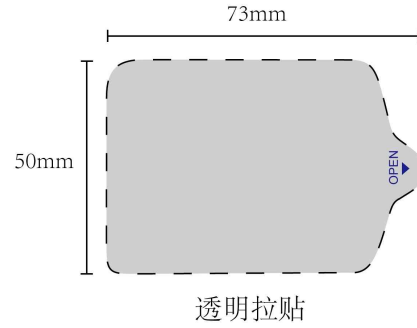

43116-004-05 60P

60片抽抑菌湿巾

135

11

46

92

46

11



CMYK



专色PANTONE号



PANTONE 21-1-7 C



PANTONE 68-1-7 C



PANTONE 103-1-1 C

60片抽抑菌湿巾

73mm

50mm

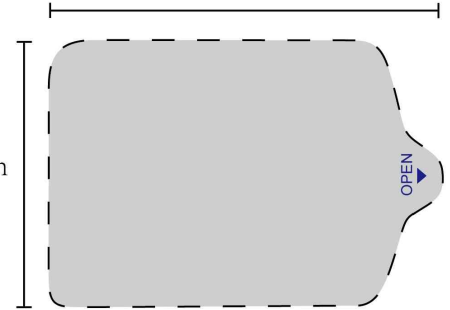

透明拉贴

43116-004-06 80P

80片抑菌湿巾尺寸

80pcs 15cmx20cm

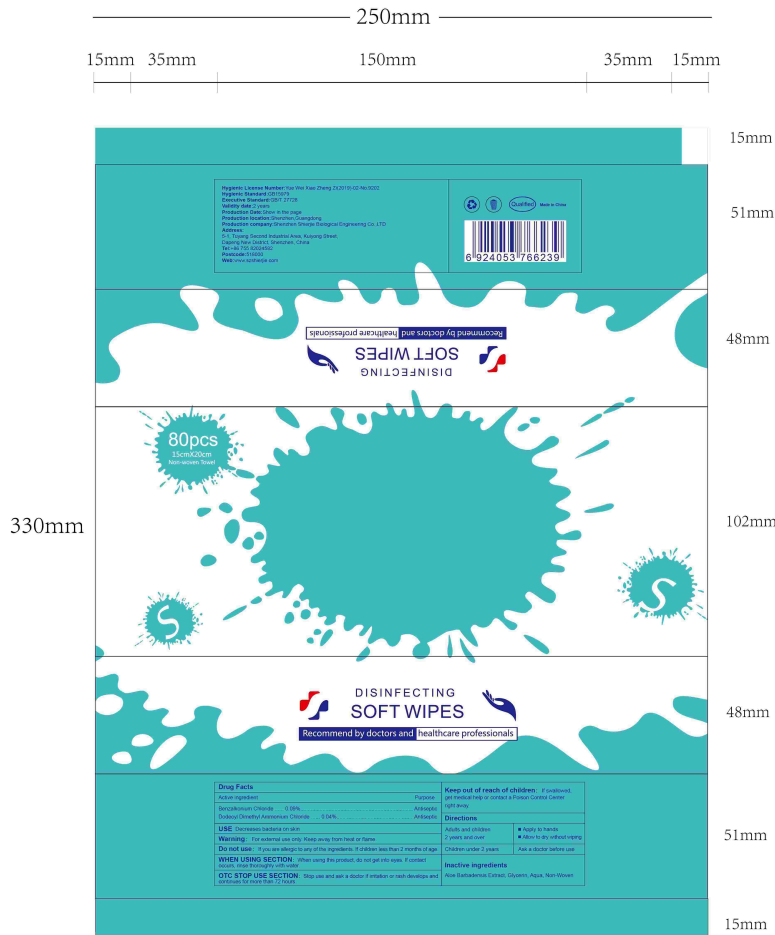

上盖:

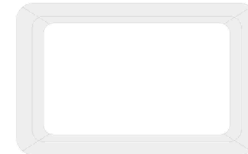

内贴:

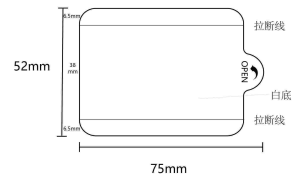

盖贴纸:

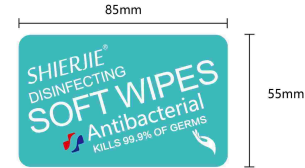

43116-004-07 90P

90片抑菌湿巾尺寸

90pcs 15cmx20cm

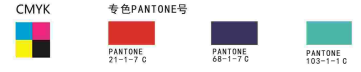
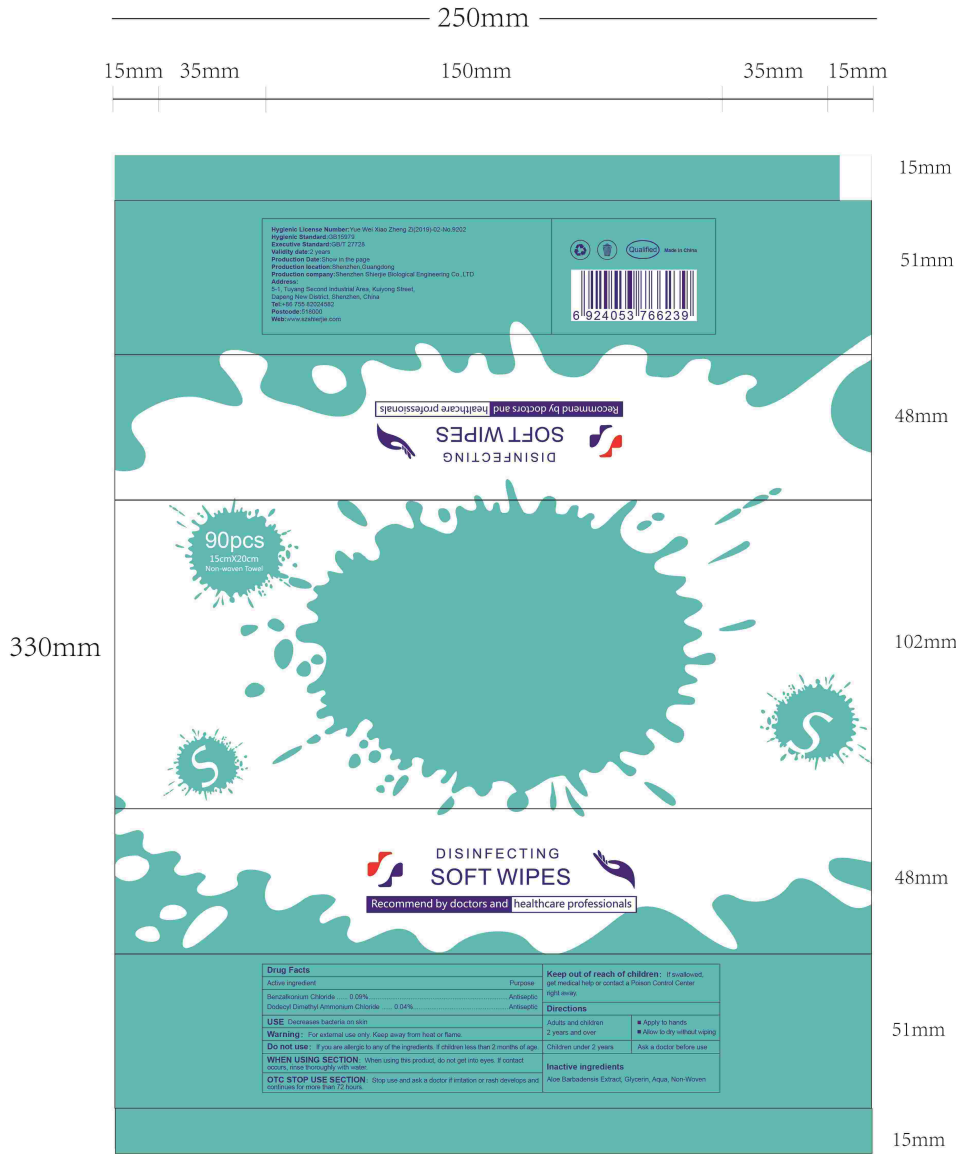

上盖:



内贴:

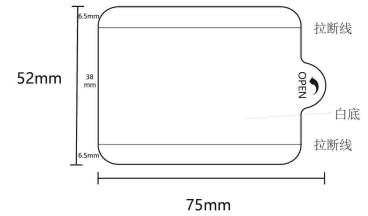

盖贴纸:

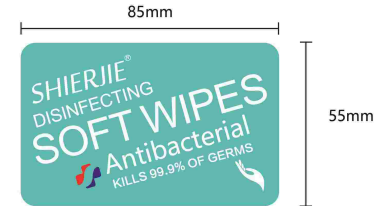

43116-004-08 100P

100片抑菌湿巾尺寸

100pcs 15cmx20cm



上盖:

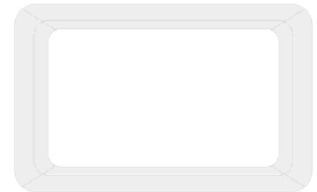

内贴:

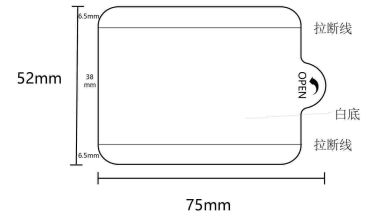

盖贴纸:

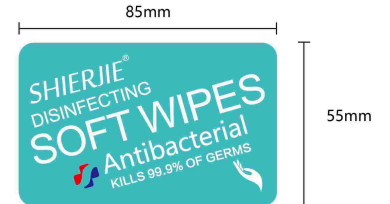

43116-004-09 120P

120片抑菌湿巾尺寸

120pcs 15cmx20cm

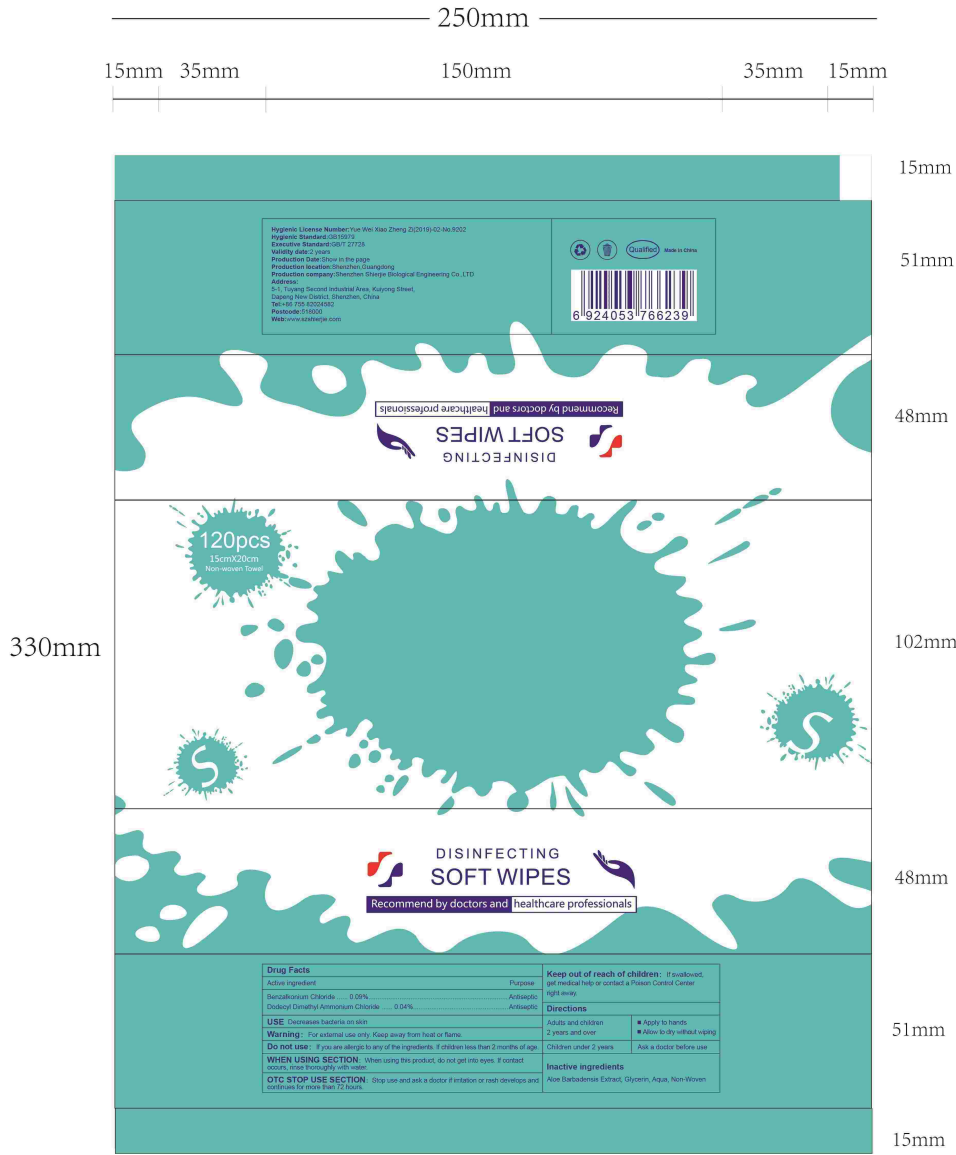

上盖:



内贴:

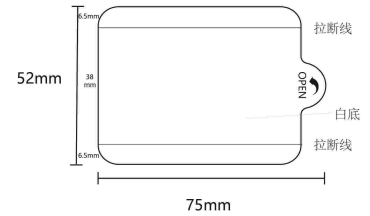

盖贴纸:

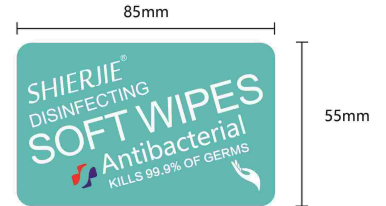

43116-004-10 60P

CMYK



专色PANTONE号



抑菌湿巾桶装60片

296mm

110mm

<p>Drug Facts</p> <p>Active ingredient Purpose</p> <p>Benzalkonium Chloride 0.09%..... Antiseptic</p> <p>Dodecyl Dimethyl Ammonium Chloride 0.04%..... Antiseptic</p> <p>USE Decreases bacteria on skin</p> <p>Warning: For external use only. Keep away from heat or flame.</p> <p>Do not use: If you are allergic to any of the ingredients. If children less than 2 months of age.</p> <p>WHEN USING SECTION: When using this product, do not get into eyes. If contact occurs, rinse thoroughly with water.</p> <p>OTC STOP USE SECTION: Stop use and ask a doctor if irritation or rash develops and continues for more than 72 hours.</p> <p>Keep out of reach of children: If swallowed, get medical help or contact a Poison Control Center right away.</p> <p>Directions</p> <table border="1"> <tr> <td>Adults and children</td> <td>Apply to hands</td> </tr> <tr> <td>2 years and over</td> <td>Allow to dry without wiping</td> </tr> <tr> <td>Children under 2 years</td> <td>Ask a doctor before use</td> </tr> </table> <p>Inactive ingredients</p> <p>Aloe Barbardensis Extract, Glycerin, Aqua, Non-Woven</p>	Adults and children	Apply to hands	2 years and over	Allow to dry without wiping	Children under 2 years	Ask a doctor before use	<p>SHIERJIE® DISINFECTING SOFT WIPES Antibacterial KILLS 99.9% OF GERMS</p> <p>60pcs 15cmX20cm Non-woven Towel</p> <p>Recommend by doctors and healthcare professionals</p>	<p>Hygienic License Number: Yue Wei Xiao Zheng Z(2019)-02-No.9202 Hygienic Standard:GB15979 Executive Standard:GB/T 27728 Validity date:2 years Production Date:Show in the page Production location:Shenzhen,Guangdong Production company: Shenzhen Shierjie Biological Engineering Co.,LTD Address: 5-1, Tuyaog Second Industrial Area, Kuyong Street, Dapeng New District, Shenzhen, China Tel:+86 755 82024582 Postcode:518000 Web:www.szshierjie.com</p> <p> </p> <p> 6 924053 766246 </p>
Adults and children	Apply to hands							
2 years and over	Allow to dry without wiping							
Children under 2 years	Ask a doctor before use							

43116-004-11 80P

CMYK



专色PANTONE号



抑菌湿巾桶装80片

296mm

110mm

<p>Drug Facts</p> <p>Active ingredient Purpose</p> <p>Benzalkonium Chloride 0.09%..... Antiseptic</p> <p>Dodecyl Dimethyl Ammonium Chloride 0.04%..... Antiseptic</p> <p>USE Decreases bacteria on skin</p> <p>Warning: For external use only. Keep away from heat or flame.</p> <p>Do not use: If you are allergic to any of the ingredients. If children less than 2 months of age.</p> <p>WHEN USING SECTION: When using this product, do not get into eyes. If contact occurs, rinse thoroughly with water.</p> <p>OTC STOP USE SECTION: Stop use and ask a doctor if irritation or rash develops and continues for more than 72 hours.</p> <p>Keep out of reach of children: If swallowed, get medical help or contact a Poison Control Center right away.</p> <p>Directions</p> <table border="1"> <tr> <td>Adults and children</td> <td>Apply to hands</td> </tr> <tr> <td>2 years and over</td> <td>Allow to dry without wiping</td> </tr> <tr> <td>Children under 2 years</td> <td>Ask a doctor before use</td> </tr> </table> <p>Inactive ingredients</p> <p>Aloe Barbardensis Extract, Glycerin, Aqua, Non-Woven</p>	Adults and children	Apply to hands	2 years and over	Allow to dry without wiping	Children under 2 years	Ask a doctor before use	<p>SHIERJIE® DISINFECTING SOFT WIPES Antibacterial KILLS 99.9% OF GERMS</p> <p>80pcs 15cmX20cm Non-woven Towel</p> <p>Recommend by doctors and healthcare professionals</p>	<p>Hygienic License Number: Yue Wei Xiao Zheng Z(2019)-02-No.9202 Hygienic Standard:GB15979 Executive Standard:GB/T 27728 Validity date:2 years Production Date:Show in the page Production location:Shenzhen,Guangdong Production company: Shenzhen Shierjie Biological Engineering Co.,LTD Address: 5-1, Tuyaog Second Industrial Area, Kuyong Street, Dapeng New District, Shenzhen, China Tel:+86 755 82024582 Postcode:518000 Web:www.szshierjie.com</p> <p> </p> <p> 6 924053 766246 </p>
Adults and children	Apply to hands							
2 years and over	Allow to dry without wiping							
Children under 2 years	Ask a doctor before use							

43116-004-12 100P

CMYK



专色PANTONE号



抑菌湿巾桶装100片

312mm

108mm

Drug Facts	
Active ingredient	Purpose
Benzalkonium Chloride 0.09%.....	Antiseptic
Dodecyl Dimethyl Ammonium Chloride 0.04%.....	Antiseptic
USE Decreases bacteria on skin	
Warning: For external use only. Keep away from heat or flame.	
Do not use: If you are allergic to any of the ingredients. If children less than 2 months of age.	
WHEN USING SECTION: When using this product, do not get into eyes. If contact occurs, rinse thoroughly with water.	
OTC STOP USE SECTION: Stop use and ask a doctor if irritation or rash develops and continues for more than 72 hours.	
Keep out of reach of children: If swallowed, get medical help or contact a Poison Control Center right away.	
Directions	
Adults and children 2 years and over	<ul style="list-style-type: none"> ■ Apply to hands ■ Allow to dry without wiping
Children under 2 years	Ask a doctor before use
Inactive ingredients	
Aloe Barbardensis Extract, Glycerin, Aqua, Non-Woven	

SHIERJIE[®] DISINFECTING SOFT WIPES Antibacterial
KILLS 99.9% OF GERMS

100pcs
15cmX20cm
Non-woven Towel

Recommend by doctors and healthcare professionals

Hygienic License Number: Yue Wei Xiao Zheng Z(2019)-02-No.9202	
Hygienic Standard: GB15979	
Executive Standard: GB/T 27728	
Validity date: 2 years	
Production Date: Show in the page	
Production location: Shenzhen,Guangdong	
Production company: Shenzhen Shierjie Biological Engineering Co.,LTD	
Address: 5-1, Tuiyong Second Industrial Area, Kuyong Street, Dapeng New District, Shenzhen, China	
Tel: +86 755 82024582	
Postcode: 518000	
Web: www.szshierjie.com	

Made in China

6 924053 766321

43116-004-13 120P

CMYK



专色PANTONE号



抑菌湿巾桶装120片

296mm

110mm

Drug Facts	
Active ingredient	Purpose
Benzalkonium Chloride 0.09%.....	Antiseptic
Dodecyl Dimethyl Ammonium Chloride 0.04%.....	Antiseptic
USE Decreases bacteria on skin	
Warning: For external use only. Keep away from heat or flame.	
Do not use: If you are allergic to any of the ingredients. If children less than 2 months of age.	
WHEN USING SECTION: When using this product, do not get into eyes. If contact occurs, rinse thoroughly with water.	
OTC STOP USE SECTION: Stop use and ask a doctor if irritation or rash develops and continues for more than 72 hours.	
Keep out of reach of children: If swallowed, get medical help or contact a Poison Control Center right away.	
Directions	
Adults and children 2 years and over	<ul style="list-style-type: none"> ■ Apply to hands ■ Allow to dry without wiping
Children under 2 years	Ask a doctor before use
Inactive ingredients	
Aloe Barbardensis Extract, Glycerin, Aqua, Non-Woven	

SHIERJIE[®] DISINFECTING SOFT WIPES Antibacterial
KILLS 99.9% OF GERMS

120pcs
15cmX20cm
Non-woven Towel

Recommend by doctors and healthcare professionals

Hygienic License Number: Yue Wei Xiao Zheng Z(2019)-02-No.9202	
Hygienic Standard: GB15979	
Executive Standard: GB/T 27728	
Validity date: 2 years	
Production Date: Show in the page	
Production location: Shenzhen,Guangdong	
Production company: Shenzhen Shierjie Biological Engineering Co.,LTD	
Address: 5-1, Tuiyong Second Industrial Area, Kuyong Street, Dapeng New District, Shenzhen, China	
Tel: +86 755 82024582	
Postcode: 518000	
Web: www.szshierjie.com	

Made in China

6 924053 766246

43116-004-14 160P

CMYK



专色PANTONE号



抑菌湿巾桶装160片

296mm

110mm

Drug Facts Active ingredient: Benzalkonium Chloride 0.09% Purpose: Antiseptic Dodecyl Dimethyl Ammonium Chloride 0.04% Purpose: Antiseptic	
USE Decreases bacteria on skin Warning: For external use only. Keep away from heat or flame.	
Do not use: If you are allergic to any of the ingredients. If children less than 2 months of age.	
WHEN USING SECTION: When using this product, do not get into eyes. If contact occurs, rinse thoroughly with water.	
OTC STOP USE SECTION: Stop use and ask a doctor if irritation or rash develops and continues for more than 72 hours.	
Keep out of reach of children: If swallowed, get medical help or contact a Poison Control Center right away.	
Directions Adults and children: Apply to hands; Allow to dry without wiping 2 years and over Children under 2 years: Ask a doctor before use	
Inactive ingredients Aloe Barbardensis Extract, Glycerin, Aqua, Non-Woven	

SHIERJIE[®] DISINFECTING SOFT WIPES Antibacterial
 KILLS 99.9% OF GERMS

160pcs
 15cmX20cm
 Non-woven Towel

Recommend by doctors and healthcare professionals

Hygienic License Number: Yue Wei Xiao Zheng Z(2019)-02-No.9202 Hygienic Standard:GB15979 Executive Standard:GB/T 27728 Validity date:2 years Production Date:Show in the page Production location:Shenzhen,Guangdong Production company: Shenzhen Shierjie Biological Engineering Co.,LTD Address: 5-1, Tusing Second Industrial Area, Kuyong Street, Dapeng New District, Shenzhen, China Tel:+86 755 82024582 Postcode:518000 Web:www.szshierjie.com
Qualified Made in China
6 924053 766246

43116-004-15 1000P

CMYK



专色PANTONE号



抑菌湿巾桶装1000片

296mm

110mm

Drug Facts Active ingredient: Benzalkonium Chloride 0.09% Purpose: Antiseptic Dodecyl Dimethyl Ammonium Chloride 0.04% Purpose: Antiseptic	
USE Decreases bacteria on skin Warning: For external use only. Keep away from heat or flame.	
Do not use: If you are allergic to any of the ingredients. If children less than 2 months of age.	
WHEN USING SECTION: When using this product, do not get into eyes. If contact occurs, rinse thoroughly with water.	
OTC STOP USE SECTION: Stop use and ask a doctor if irritation or rash develops and continues for more than 72 hours.	
Keep out of reach of children: If swallowed, get medical help or contact a Poison Control Center right away.	
Directions Adults and children: Apply to hands; Allow to dry without wiping 2 years and over Children under 2 years: Ask a doctor before use	
Inactive ingredients Aloe Barbardensis Extract, Glycerin, Aqua, Non-Woven	

SHIERJIE[®] DISINFECTING SOFT WIPES Antibacterial
 KILLS 99.9% OF GERMS

1000pcs
 15cmX20cm
 Non-woven Towel

Recommend by doctors and healthcare professionals

Hygienic License Number: Yue Wei Xiao Zheng Z(2019)-02-No.9202 Hygienic Standard:GB15979 Executive Standard:GB/T 27728 Validity date:2 years Production Date:Show in the page Production location:Shenzhen,Guangdong Production company: Shenzhen Shierjie Biological Engineering Co.,LTD Address: 5-1, Tusing Second Industrial Area, Kuyong Street, Dapeng New District, Shenzhen, China Tel:+86 755 82024582 Postcode:518000 Web:www.szshierjie.com
Qualified Made in China
6 924053 766246

SHIERJIE DISINFECTING SOFT WIPES ANTIBACTERIAL

shierjie disinfecting soft wipes antibacterial cloth

Product Information

Product Type	HUMAN OTC DRUG	Item Code (Source)	NDC:43116-026
Route of Administration	TOPICAL		

Active Ingredient/Active Moiety

Ingredient Name	Basis of Strength	Strength
BENZALKONIUM CHLORIDE (UNII: F5UM2KM3W7) (BENZALKONIUM - UNII:7N6JUD5X6Y)	BENZALKONIUM CHLORIDE	0.09 g in 100
DIDECYLDIMONIUM CHLORIDE (UNII: JXN40O9Y9B) (DIDECYLDIMONIUM - UNII:Z7F472XQPA)	DIDECYLDIMONIUM CHLORIDE	0.04 g in 100

Inactive Ingredients

Ingredient Name	Strength
ALOE VERA FLOWER (UNII: 575DY8C1ER)	
WATER (UNII: 059QF0KO0R)	
GLYCERIN (UNII: PDC6A3C0OX)	

Packaging

#	Item Code	Package Description	Marketing Start Date	Marketing End Date
1	NDC:43116-026-01	1 in 1 BAG; Type 0: Not a Combination Product	03/31/2020	
2	NDC:43116-026-02	10 in 1 BAG; Type 0: Not a Combination Product	03/31/2020	
3	NDC:43116-026-03	40 in 1 BAG; Type 0: Not a Combination Product	03/31/2020	
4	NDC:43116-026-04	50 in 1 BAG; Type 0: Not a Combination Product	03/31/2020	
5	NDC:43116-026-05	60 in 1 BAG; Type 0: Not a Combination Product	03/31/2020	
6	NDC:43116-026-06	80 in 1 BAG; Type 0: Not a Combination Product	03/31/2020	
7	NDC:43116-026-07	90 in 1 BAG; Type 0: Not a Combination Product	03/31/2020	
8	NDC:43116-026-08	100 in 1 BAG; Type 0: Not a Combination Product	03/31/2020	
9	NDC:43116-026-09	120 in 1 BAG; Type 0: Not a Combination Product	03/31/2020	
10	NDC:43116-026-10	60 in 1 DRUM; Type 0: Not a Combination Product	03/31/2020	
11	NDC:43116-026-11	80 in 1 DRUM; Type 0: Not a Combination Product	03/31/2020	
12	NDC:43116-026-12	100 in 1 DRUM; Type 0: Not a Combination Product	03/31/2020	
13	NDC:43116-026-13	120 in 1 DRUM; Type 0: Not a Combination Product	03/31/2020	
14	NDC:43116-026-14	160 in 1 DRUM; Type 0: Not a Combination Product	03/31/2020	
15	NDC:43116-026-15	1000 in 1 DRUM; Type 0: Not a Combination Product	03/31/2020	

Marketing Information

Marketing Category	Application Number or Monograph Citation	Marketing Start Date	Marketing End Date
OTC monograph not final	part333A	03/31/2020	

Labeler - Shenzhen Shierjie Biological Engineering Co., LTD (547610261)

Establishment

Name	Address	ID/FEI	Business Operations
Shenzhen Shierjie Biological Engineering Co., LTD		547610261	manufacture(43116-026)