

PERFECTINT POWDER SPF 40 ALL SHADES- zinc oxide powder
Science of Skincare

PerfectTint Powder SPF 40 (69219-111)

Zinc Oxide 25%

Sunscreen

Apply liberally 15 minutes before sun exposure

For external use only

Do not use on damaged or broken skin

When using this product keep out of eyes.

Rinse with water to remove.

Stop use and ask a doctor if rash occurs

Keep out of reach of children. If product is swallowed, get medical help or contact a Poison Control Center right away

Apply liberally 15 minutes before sun exposure.

Use a water-resistant sunscreen if swimming or sweating.

Reapply at least every 2 hours.

Sun Protection Measures. Spending time in the sun increase your risk of skin cancer and early skin aging. To decrease this risk, regularly use a sunscreen with a broad spectrum SPF value of 15 or higher and other sun protection measures including:

limit time in the sun, especially from 10am - 2pm.

wear long-sleeve shirts, pants, hats, and sunglasses

Children under 6 months: Ask a doctor

Protect this product from excessive heat and direct sun.

Call Customer Care at (888)-804-4447

Mica, Dimethicone/Vinyl Dimethicone Crosspolymer, Calcium Sodium Borosilicate, Hydroxyapatite, Methyl Methacrylate Crosspolymer, Sodium Anisate, Lycopodium Clavatum Extract, Imperata Cylindrica Root Extract, Capryloyl Glycine, Glycerin, Triethoxycaprylylsilane, Iron Oxides (CI 77491*, CI 77499*, CI 77492*). *may contain one or more of these ingredients

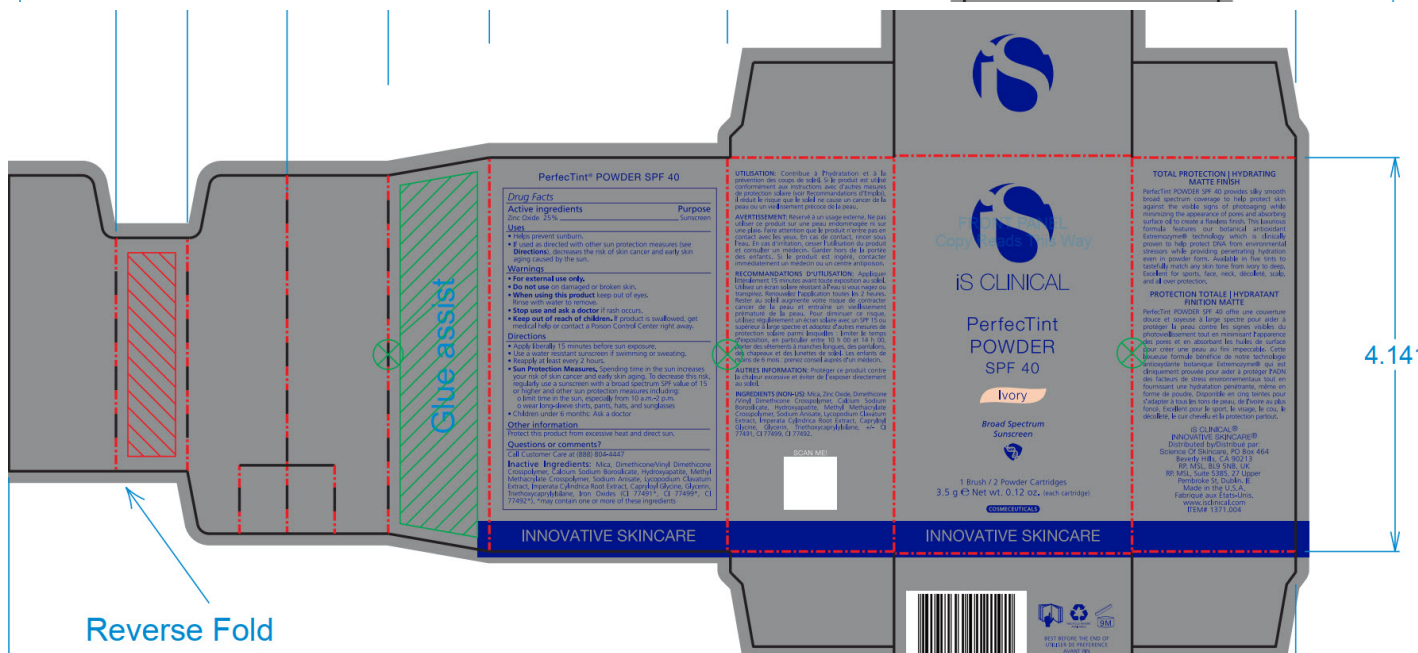
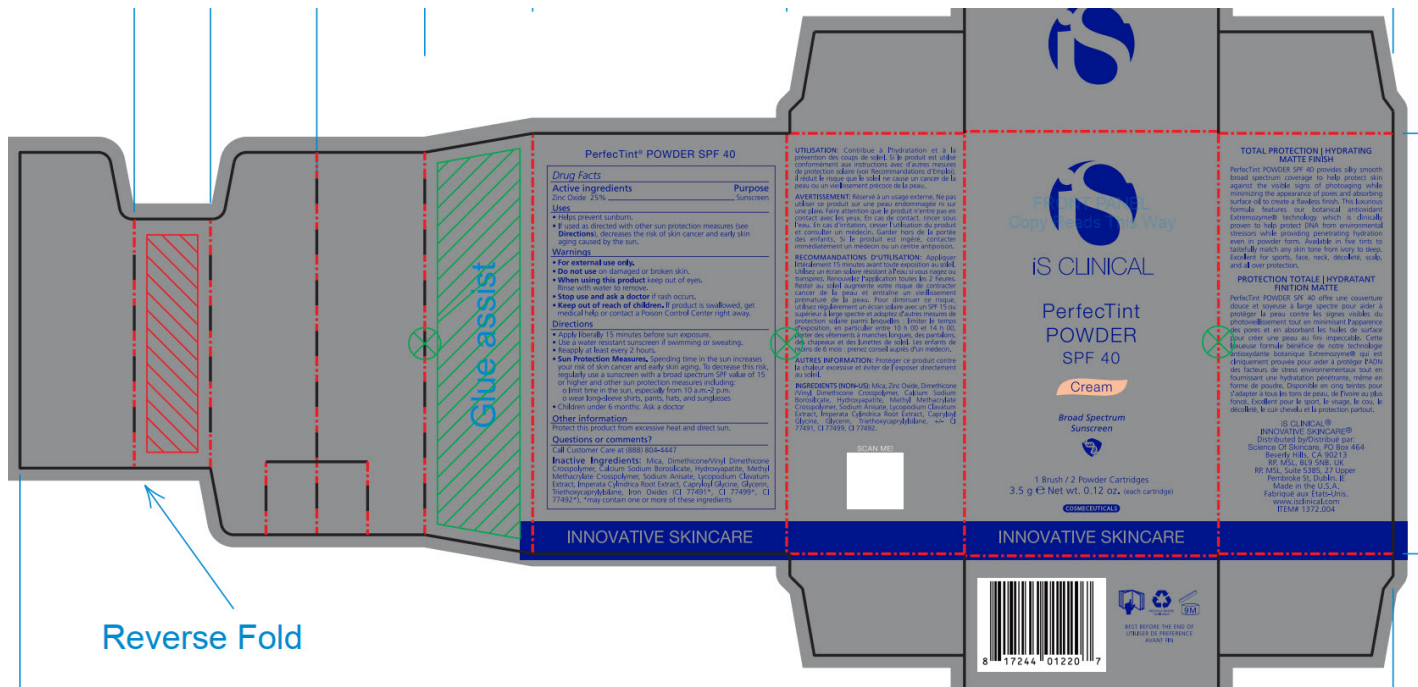

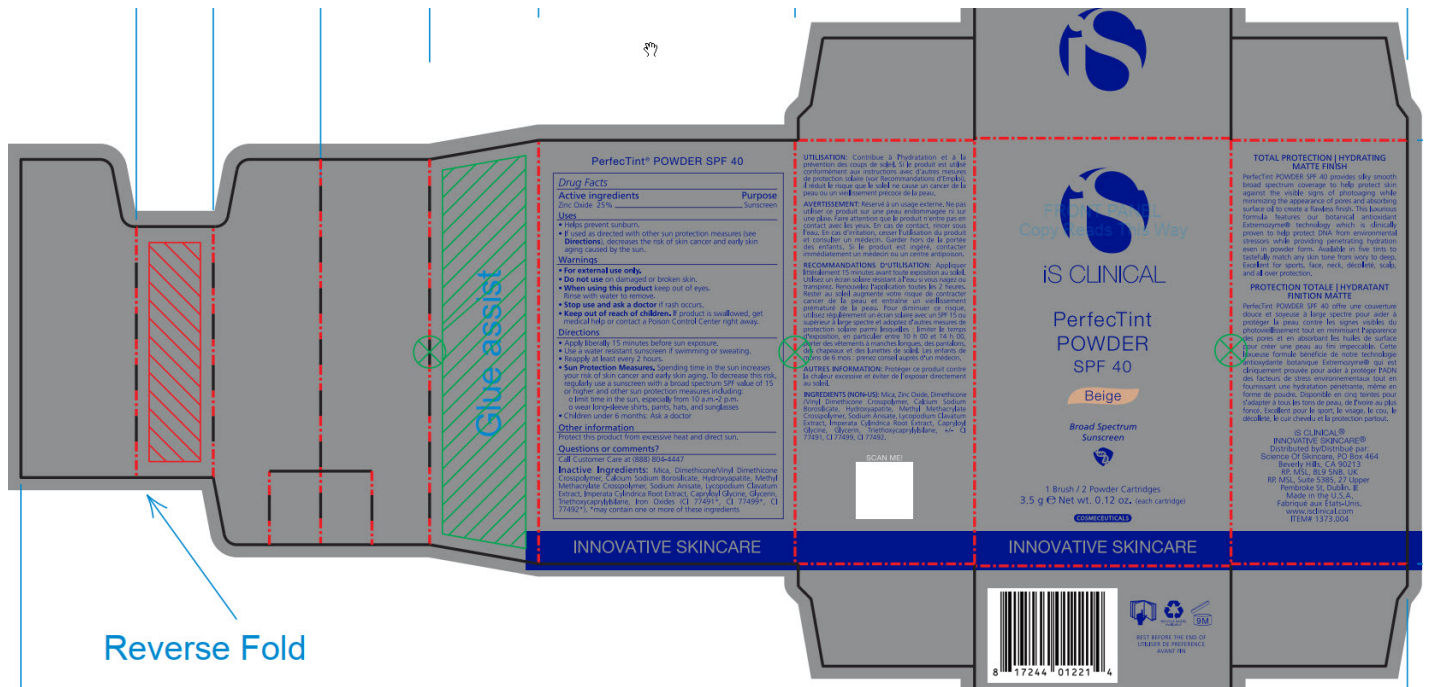

Reverse Fold

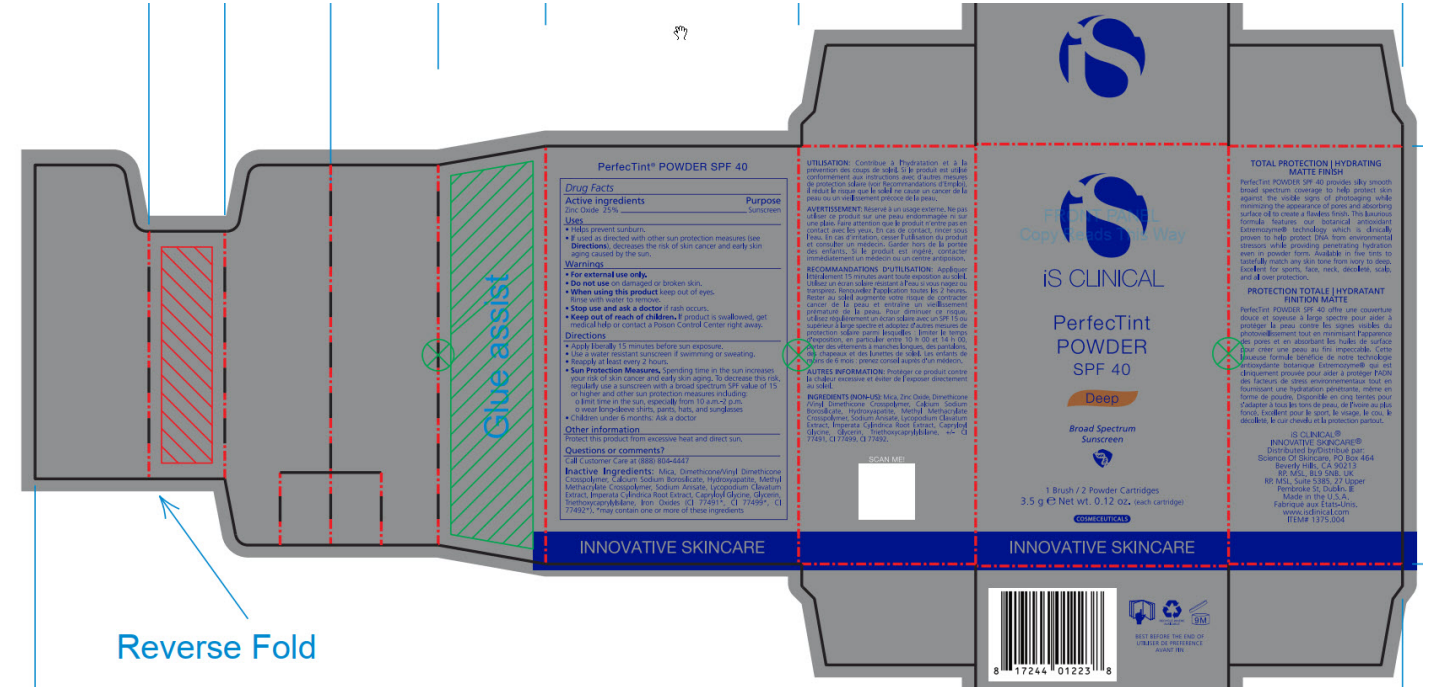

Reverse Fold

PerfectTint® POWDER SPF 40

Drug Facts
Active Ingredients Purpose
 Zinc Oxide 55% Sunscreen

Uses
 • Helps prevent sunburn.
 • If used as directed with other sun protection measures (see Directions), decreases the risk of skin cancer and early skin aging caused by the sun.

Warnings
 • **For external use only.**
 • Do not use on damaged or broken skin.
 • **When using this product** keep out of eyes.
 • Rinse with water to remove.
 • **Stop use and ask a doctor if rash occurs.**
 • **Keep out of reach of children.** If product is swallowed, get medical help or contact a Poison Control Center right away.

Directions
 • Use a water resistant sunscreen if swimming or sweating.
 • Reapply at least every 2 hours.
 • **Apply liberally** 15 minutes before sun exposure.
 • Use a water resistant sunscreen if swimming or sweating.
 • **Sun Protection Measures.** Spending time in the sun increases your risk of skin cancer and early skin aging. To decrease this risk, regularly use a sunscreen with a broad spectrum SPF value of 15 or higher and other sun protection measures including: wearing protective clothing, hats, and sunglasses.
 • Children under 6 months: Ask a doctor.

Other information
 Protect this product from excessive heat and direct sun.

Questions or comments?
 Call Customer Care at (866) 854-4447

Inactive Ingredients: Mica, Dimethicone/Vinyl Dimethicone Crosspolymer, Calcium Sodium Borosilicate, Hydroxyapatite, Methyl Methacrylate Copolymer, Sodium Acrylate, Irganox 1010, Calcium Stearate, Iron Oxides (CI 77491), CI 77499, CI 77492, CI 77492-1. *May contain one or more of these ingredients.

UTILISATION: Conserve à l'extérieur et à la protection des coups de soleil. Si le produit est utilisé conformément aux instructions, aide à réduire le risque de protection solaire. Pour des recommandations d'emploi, consultez le dossier d'information sur le produit ou contactez votre pharmacien.

AVERTISSEMENT: Ne pas utiliser sur une peau endommagée ou brisée. Ne pas utiliser ce produit sur une peau endommagée ou brisée. Évitez le contact avec les yeux. En cas de contact, rincer avec l'eau. En cas d'irritation, cessez l'utilisation du produit et consultez un médecin. Gardez hors de la portée des enfants. Si le produit est ingéré, contactez immédiatement un médecin ou un centre antipoison.

RECOMMANDATIONS D'UTILISATION: Appliquez libéralement 15 minutes avant toute exposition au soleil. Utilisez un écran solaire résistant à l'eau si vous nagez ou nagez. Rincez avec de l'eau après utilisation. Évitez le contact avec les yeux. En cas de contact, rincer avec l'eau. En cas d'irritation, cessez l'utilisation du produit et consultez un médecin. Gardez hors de la portée des enfants. Si le produit est ingéré, contactez immédiatement un médecin ou un centre antipoison.

AUTRES INFORMATIONS: Protéger ce produit contre la chaleur excessive et éviter de l'exposer directement au soleil.

INGRÉDIENTS NON-DES: Mica, Zinc Oxide, Diméthylsiloxane, Copolymère de Calcium Sodium Borosilicate, Hydroxyapatite, Méthyl Méthacrylate Copolymère, Acrylate de Sodium, Irganox 1010, Calcium Stearate, Oxyde de Fer (CI 77491), CI 77499, CI 77492.

iS
 Copy Means Way
iS CLINICAL
 PerfectTint
 POWDER
 SPF 40
 Beige
 Broad Spectrum
 Sunscreen
 1 Brush / 2 Powder Cartridges
 3.5 g e Net Wt. 0.12 oz. (each cartridge)
COMERCIAL
INNOVATIVE SKINCARE

TOTAL PROTECTION | HYDRATING MATTE FINISH
 PerfectTint POWDER SPF 40 provides silky smooth broad spectrum coverage to help protect skin against the visible signs of photodamage while minimizing the appearance of pores and absorbing surface oil to create a flawless finish. This innovative formula features our botanical antioxidant Extensym™ technology which is clinically proven to help protect DNA from environmental stressors while providing penetrating hydration in powder form. Available in five tones to easily match any skin tone from very to deep. Ideal for sports, face, neck, décolleté, back, and all over protection.

PROTECTION TOTALE | HYDRATANT FINITION MATE
 PerfectTint POWDER SPF 40 offre une couverture douce et posee a large spectre pour aider a proteger la peau contre les signes visibles du vieillissement tout en minimisant l'apparence des pores et en absorbant les huiles de surface pour creer une peau au fini impeccable. Cette nouvelle formule beneficie de notre technologie antioxidante botanique Extensym™ qui est cliniquement prouvee pour aider a proteger l'ADN des facteurs de stress environnementaux tout en fournissant une hydratation penetrante, meme en forme de poudre. Disponible en cinq tons pour s'adapter a tous les tons de peau, de Fonce au plus foncé. Facilement pour le sport, le voyage, le cou, le décolleté, le cou et le dos et la protection partout.



iS CLINICAL®
 INNOVATIVE SKINCARE®
 Distributed by Distributeur par
 Science Of Skincare, PO Box 464
 Beverly Hills, CA 90213
 RR MSJ, Suite 5385, 27 Upper
 Peninsula St, Dublin, E
 Made in the U.S.A.
 Fabricated aux États-Unis
 www.isclinical.com
 ITEM 1375.004





TOTAL PROTECTION | HYDRATING MATTE FINISH
 PerfectTint POWDER SPF 40 provides silky smooth broad spectrum coverage to help protect skin against the visible signs of photodamage while minimizing the appearance of pores and absorbing surface oil to create a flawless finish. This innovative formula features our botanical antioxidant Extensym™ technology which is clinically proven to help protect DNA from environmental stressors while providing penetrating hydration in powder form. Available in five tones to easily match any skin tone from very to deep. Ideal for sports, face, neck, décolleté, back, and all over protection.

PROTECTION TOTALE | HYDRATANT FINITION MATE
 PerfectTint POWDER SPF 40 offre une couverture douce et posee a large spectre pour aider a proteger la peau contre les signes visibles du vieillissement tout en minimisant l'apparence des pores et en absorbant les huiles de surface pour creer une peau au fini impeccable. Cette nouvelle formule beneficie de notre technologie antioxidante botanique Extensym™ qui est cliniquement prouvee pour aider a proteger l'ADN des facteurs de stress environnementaux tout en fournissant une hydratation penetrante, meme en forme de poudre. Disponible en cinq tons pour s'adapter a tous les tons de peau, de Fonce au plus foncé. Facilement pour le sport, le voyage, le cou, le décolleté, le cou et le dos et la protection partout.

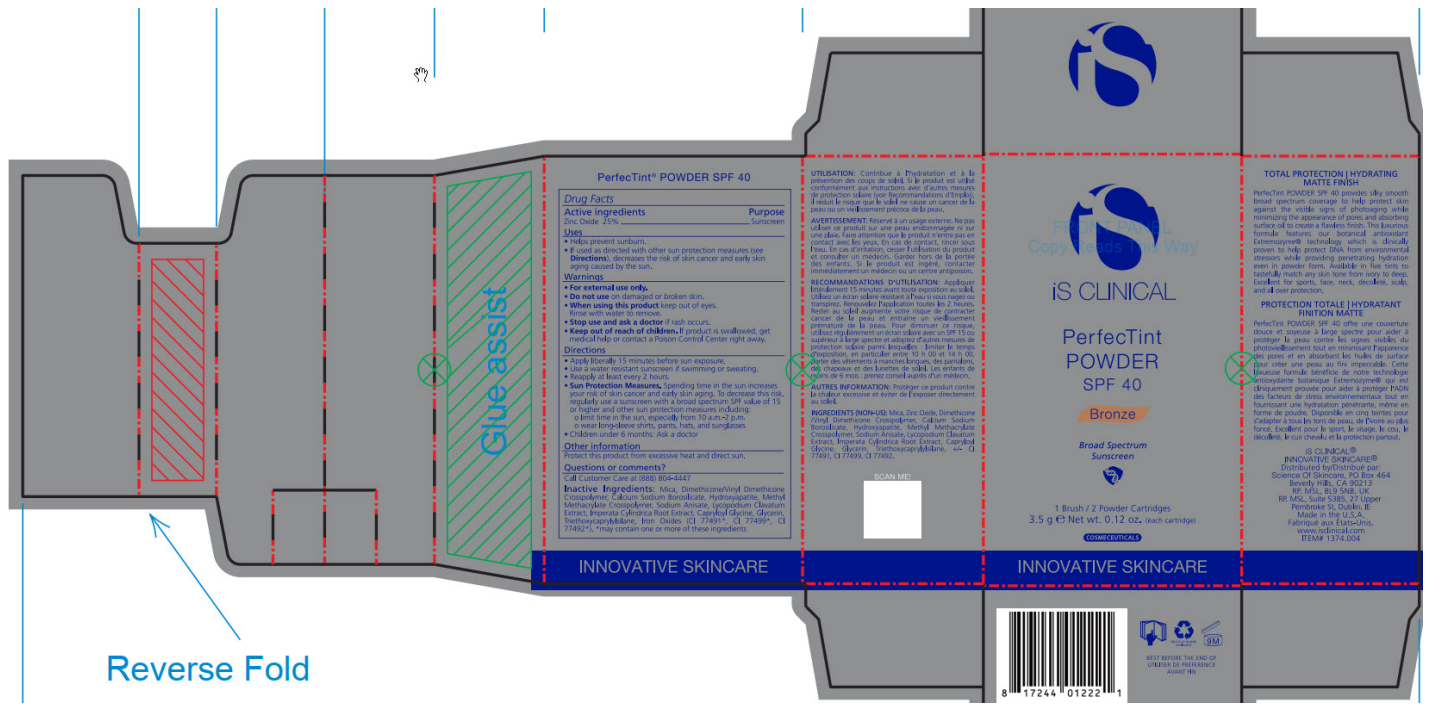

iS CLINICAL®
 INNOVATIVE SKINCARE®
 Distributed by Distributeur par
 Science Of Skincare, PO Box 464
 Beverly Hills, CA 90213
 RR MSJ, Suite 5385, 27 Upper
 Peninsula St, Dublin, E
 Made in the U.S.A.
 Fabricated aux États-Unis
 www.isclinical.com
 ITEM 1375.004





Reverse Fold

DESCRIPTION/VERSION#: PefecTint Powder SPF 40 - Bronze Label		
DESIGNER/ARTIST: Cynthia	REQUESTED BY: Marketing	DATE: 1/21/2021
ITEM #: LBL.1374.004.POT.2052		<input checked="" type="checkbox"/> NEW PROJECT <input type="checkbox"/> UPDATE
CHANGES MADE:		
<input type="checkbox"/> 4-COLOR PROCESS/CMYK	<input checked="" type="checkbox"/> SPOT COLOR/PANTONE	<div style="display: flex; justify-content: space-around; align-items: center;"> <div style="text-align: center;">  Blue PMS 072 C </div> <div style="text-align: center;">  PMS 4645 U </div> </div>
PAPER STOCK: White Bopp	PRINTING FINISH DEALS: Clear UV	
OVERALL SIZE: 2cm round shape		
— DIE CUT		



DESCRIPTION/VERSION#: PefecTint Powder SPF 40 - Beige Label		
DESIGNER/ARTIST: Cynthia		DATE: 1/21/2021
ITEM #: LBL.1373.004.POT.2052	REQUESTED BY: Marketing	<input checked="" type="checkbox"/> NEW PROJECT <input type="checkbox"/> UPDATE
CHANGES MADE:		
<input type="checkbox"/> 4-COLOR PROCESS/CMYK	<input checked="" type="checkbox"/> SPOT COLOR/PANTONE	 Blue PMS 072 C  PMS 4665 U
PAPER STOCK: White Bopp	PRINTING FINISH DEALS: Clear UV	
OVERALL SIZE: 2cm round shape		
 DIE CUT		



DESCRIPTION/VERSION#: PefecTint Powder SPF 40 - Deep Label		
DESIGNER/ARTIST: Cynthia		DATE: 1/21/2021
ITEM #: LBL.1375.004.POT.2052	REQUESTED BY: Marketing	<input checked="" type="checkbox"/> NEW PROJECT <input type="checkbox"/> UPDATE
CHANGES MADE:		
<input type="checkbox"/> 4-COLOR PROCESS/CMYK	<input checked="" type="checkbox"/> SPOT COLOR/PANTONE	 Blue PMS 072 C  PMS 4635 U
PAPER STOCK: White Bopp	PRINTING FINISH DEALS: Clear UV	
OVERALL SIZE: 2cm round shape		
 DIE CUT		



DESCRIPTION/VERSION#: PefecTint Powder SPF 40 - Ivory Label

DESIGNER/ARTIST: Cynthia

DATE: 1/21/2021

ITEM #: LBL.1371.004.POT.2052

REQUESTED BY: Marketing

NEW PROJECT UPDATE

CHANGES MADE:

4-COLOR PROCESS/CMYK

SPOT COLOR/PANTONE

Blue PMS 072 C

PMS 475 U

PAPER STOCK: White Bopp



PRINTING FINISH DETAILS: Clear UV

OVERALL SIZE: 2cm round shape

 DIE CUT



DESCRIPTION/VERSION#: PefecTint Powder SPF 40 - Cream Label

DESIGNER/ARTIST: Cynthia		DATE: 1/21/2021
ITEM #: LBL.1372.004.POT.2052	REQUESTED BY: Marketing	<input checked="" type="checkbox"/> NEW PROJECT <input type="checkbox"/> UPDATE
CHANGES MADE:		
<input type="checkbox"/> 4-COLOR PROCESS/CMYK	<input checked="" type="checkbox"/> SPOT COLOR/PANTONE	 Blue PMS 072 C  PMS 473 U
PAPER STOCK: White Bopp	PRINTING FINISH DEALS: Clear UV	
OVERALL SIZE: 2cm round shape		
 DIE CUT		



Version : A0

COLLAR/BASE MAX DECO AREA

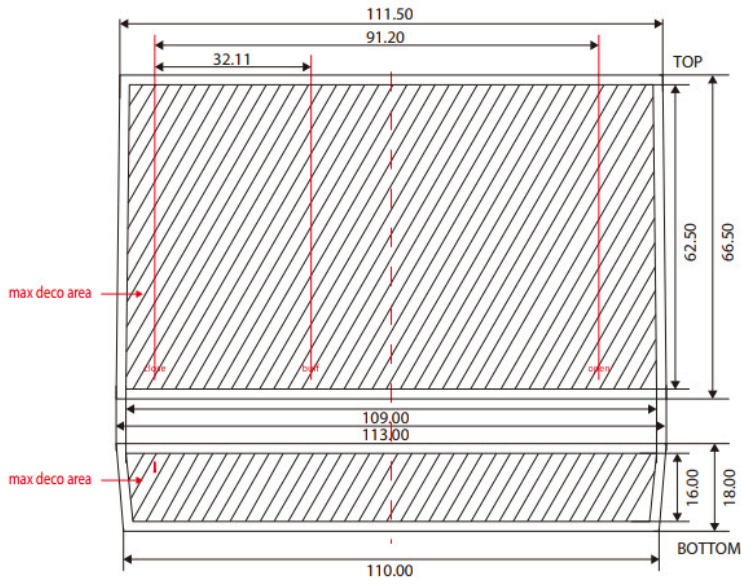

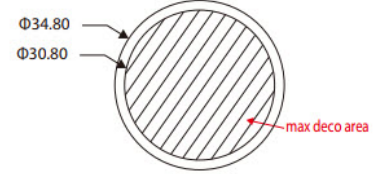

REVISIONS			
REV	DESCRIPTION	REV.BY	DATE
1	RELEASED	RY	19/08/21

CAP MAX DECO AREA

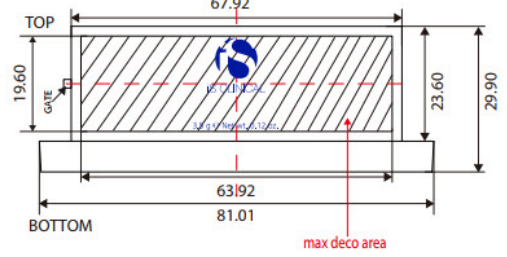

POT MAX DECO AREA



DESCRIPTION/VERSION: PerfectTint Powder SPF 40 - Ref Pot Hot Stamp		
DESIGNER/DRAWER: Cynthia	DATE: 17/5/2021	
ITEM #: SCL1370204POT_2052	REQUESTED BY: Marketing	<input checked="" type="checkbox"/> NEW PROJECT <input type="checkbox"/> UPDATE
CHANGES MADE:		
<input type="checkbox"/> 4-COLOR PROCESS/CMYK	<input checked="" type="checkbox"/> SPOT COLOR/PANTONE	 Crown 500 Hot Stamp

Version : A0

COLLAR/BASE MAX DECO AREA

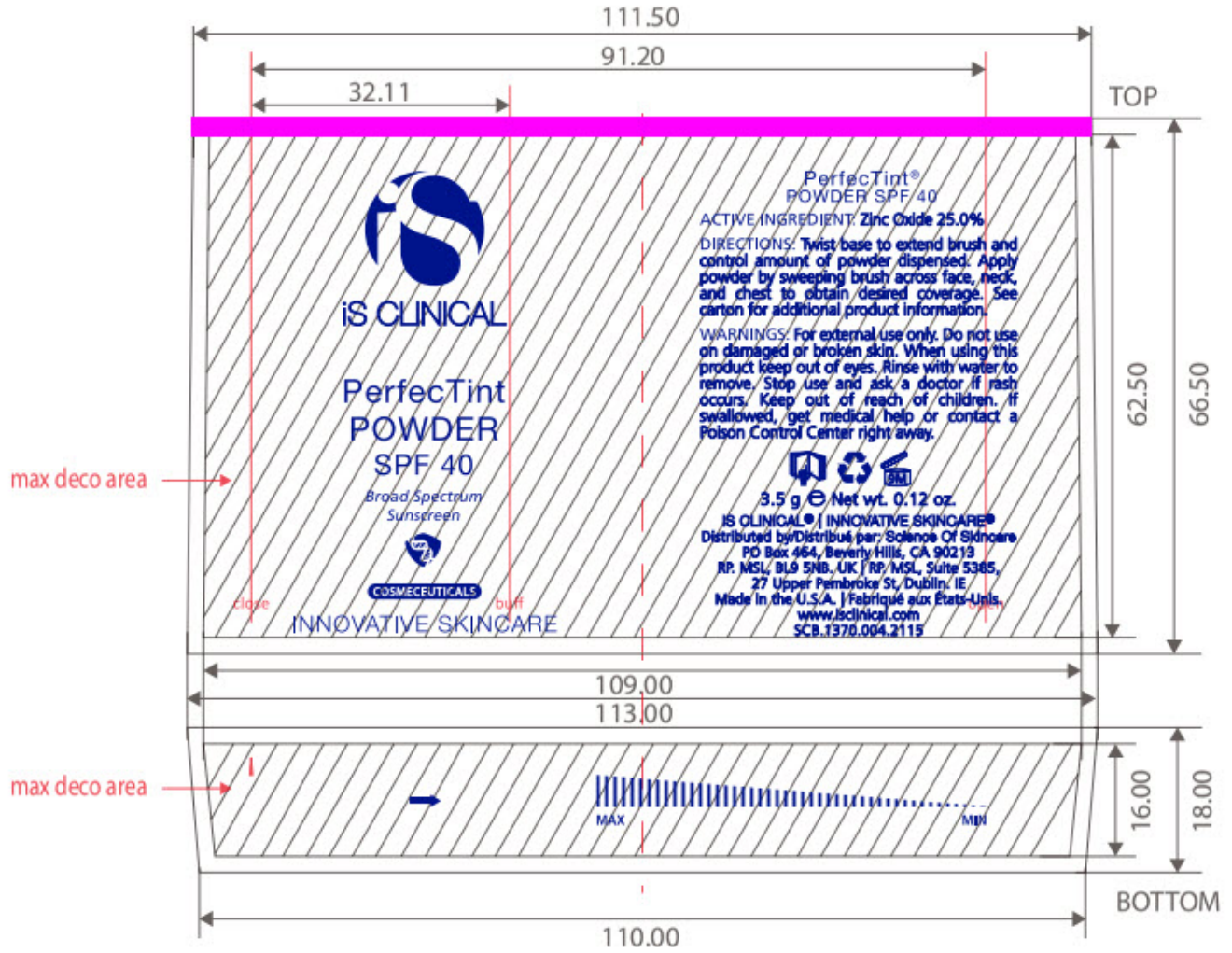

DESCRIPTION/VERSION#: PerfectTint SPF 40 3.5g Container		
DESIGNER/ARTIST: Cynthia	DATE: 4/7/21	
ITEM #: SCB.1370.004.2115	REQUESTED BY: Marketing	<input type="checkbox"/> NEW PROJECT <input checked="" type="checkbox"/> UPDATE
CHANGES MADE: Add Extremozymes logo. ADJUSTED ART TO MATCH PROOF.		
<input checked="" type="checkbox"/> 4-COLOR PROCESS/CMYK	<input type="checkbox"/> Flood with PMS 877 C	<input checked="" type="checkbox"/> Custom Blue
<input checked="" type="checkbox"/> SPOT COLOR/PANTONE	<input type="checkbox"/> Hot Stamp	
OVERALL SIZE:	<input checked="" type="checkbox"/> UV GLOSS	

PERFECTINT POWDER SPF 40 ALL SHADES

zinc oxide powder

Product Information

Product Type	HUMAN OTC DRUG	Item Code (Source)	NDC:69219-111
Route of Administration	TOPICAL		

Active Ingredient/Active Moiety

Ingredient Name	Basis of Strength	Strength
ZINC OXIDE (UNII: SOI2LOH54Z) (ZINC OXIDE - UNII:SOI2LOH54Z)	ZINC OXIDE	25 g in 100 g

Inactive Ingredients

Ingredient Name	Strength
FERRIC OXIDE YELLOW (UNII: EX43802MRT)	
TRIETHOXYCAPRYLYLSILANE (UNII: LDC331P08E)	
MICA (UNII: V8A1AW0880)	
CALCIUM ALUMINUM BOROSILICATE (UNII: 3JRB8A35M0)	
SODIUM ANISATE (UNII: F9WFJ28MV9)	
LYCOPODIUM CLAVATUM WHOLE (UNII: 005ICF6L27)	
CAPRYLOYL GLYCINE (UNII: 8TY5YO42NJ)	
TRIBASIC CALCIUM PHOSPHATE (UNII: 91D9GV0Z28)	
IMPERATA CYLINDRICA ROOT (UNII: VYT2JA85NH)	
GLYCERIN (UNII: PDC6A3C0OX)	
FERROSFERRIC OXIDE (UNII: XM0M87F357)	
DIMETHICONE/VINYL DIMETHICONE CROSSPOLYMER (SOFT PARTICLE) (UNII: 9E4CO0W6C5)	
METHYL METHACRYLATE/GLYCOL DIMETHACRYLATE CROSSPOLYMER (UNII: EG97988M5Q)	
FERRIC OXIDE RED (UNII: 1K09F3G675)	

Packaging

#	Item Code	Package Description	Marketing Start Date	Marketing End Date
1	NDC:69219-111-01	3.5 g in 1 BOTTLE, PLASTIC; Type 0: Not a Combination Product	12/19/2023	
2	NDC:69219-111-11	1 in 1 BOX	12/19/2023	
2	NDC:69219-111-01	3.5 g in 1 BOTTLE, PLASTIC; Type 0: Not a Combination Product		

Marketing Information

Marketing Category	Application Number or Monograph Citation	Marketing Start Date	Marketing End Date
OTC Monograph Drug	M020	12/19/2023	

Labeler - Science of Skincare (006251958)