

(b) (4)

UNVARNISHED AND PRINTED IN BLACK OR DARK BLUE FOR LOT & EXPIRATION AREA.

3/16" X 3/16" DATA MATRIX CODE (ECC 200), PRINTED IN BLACK OR DARK BLUE ON UNPRINTED WHITE BACKGROUND.
DATA MATRIX CODE = 079994

3/8" HINGE AREA UNVARNISHED

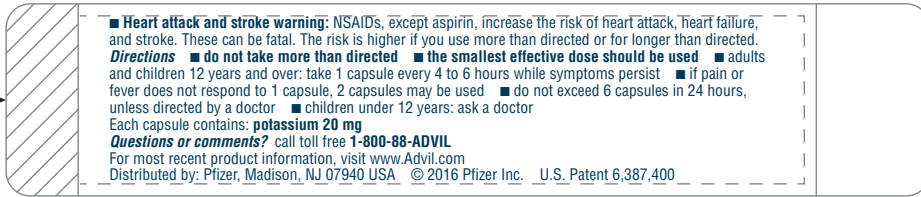

(b) (4)

BASE
PANEL 3

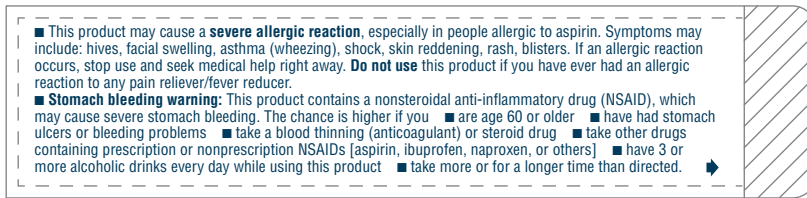

3/8" HINGE AREA UNVARNISHED

(b) (4)

RELEASED BACK
PANEL 2

PRODUCTION

(NOT COLOR ACCURATE)

Job Information	Color Legend
Date 11-OCT-2016 PASS # 1 Component # PAA079994.FDA01 Drawing # DWG-00000785v02	(b) (4)
Identification	
Consumer Healthcare	
(b) (4)	Printer & User Notes
	PRINTER TO REPLACE ALL FPO CODES WITH SCANNABLE ART. PRINTER RESPONSIBLE FOR ALL TRAPPING, BLEEDS, COATINGS AND RESOLUTION. PRINTER AND USERS RESPONSIBLE FOR PROPER LICENSING OF ALL FONTS USED IN THIS ARTWORK.
Vendor Identification	
(b) (4)	
Graphic Artist (b) (4)	

DRUG FACTS TEXT DEFINED	TYPE SIZE
• HEADINGS	5.85 pt
• SUBHEADINGS/BODY TEXT	5.85 pt
• LEADING	6.35 pt
• BULLETS	4.85 pt
• SPACE BEFORE BULLET	2 ems
• WARNING BOX LINE, HAIRLINES	.5 pt

090177e189d24d0fFinalOn: 14-Oct-2016 20:10

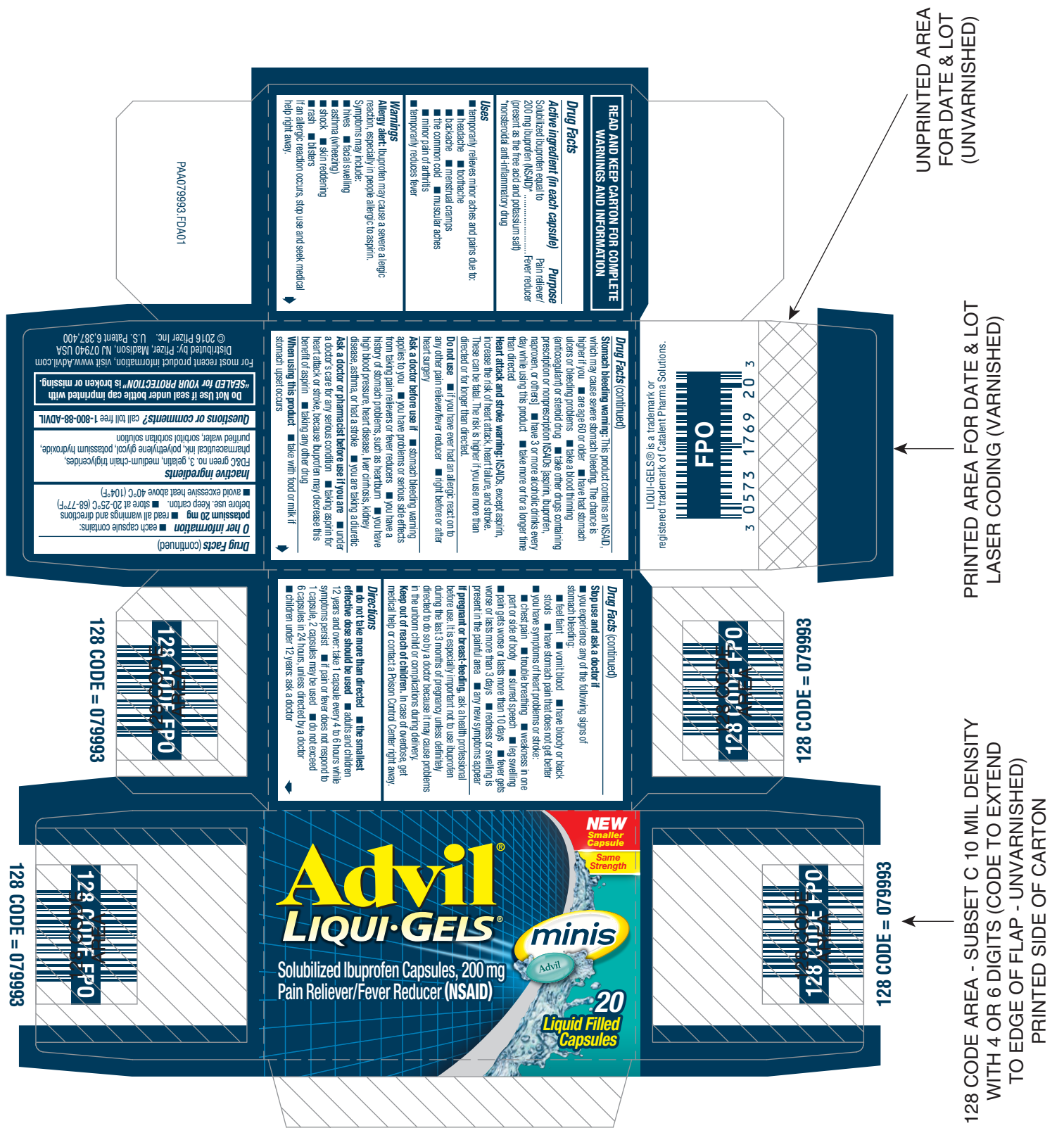

Silver Foil Stamp
Full size file on Silver Foil layer
Must open file with Illustrator

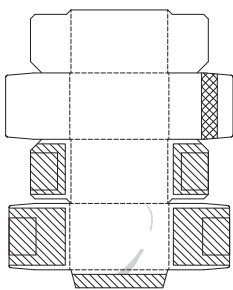

Embossing #1
Full size file on Emboss #1 layer
Must open file with Illustrator

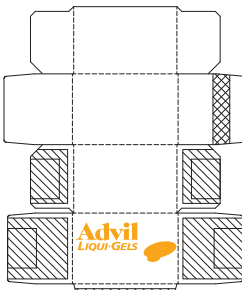

Embossing #2 sculptured
Full size file on Emboss #2 layer
Must open file with Illustrator

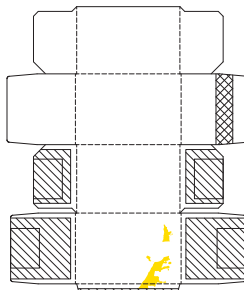

High Gloss Varnish and Matte Coating -
Full size file on Coating layers
Must open file with Illustrator

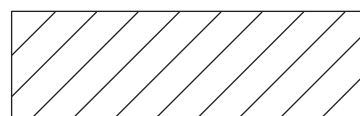

UNVARNISHED AREAS

PRODUCTION

(NOT COLOR ACCURATE)

Job Information	Color Legend
Date 07-OCT-2016 PASS # 1 Component # PAA079993.FDA01 Drawing # DWG-00001042v04	(b) (4)
Identification	
Vendor Identification	
Graphic Artist: (b) (4)	
Printer & User Notes	
PRINTER TO REPLACE ALL FPO CODES WITH SCANNABLE ART. PRINTER RESPONSIBLE FOR ALL TRAPPING, BLEEDS, COATINGS AND RESOLUTION. PRINTER AND USERS RESPONSIBLE FOR PROPER LICENSING OF ALL FONTS USED IN THIS ARTWORK.	

DRUG FACTS MODIFIED TEXT DEFINED	TYPE SIZE
• DRUG FACTS TITLE	8 pt
• DRUG FACTS CONTINUED	7 pt
• HEADINGS	7 pt
• SUBHEADINGS/BODY TEXT	6 pt
• LEADING	6.25 pt
• # OF CHARACTERS PER INCH	<39
• BULLETS	5 pt
• SPACE BEFORE BULLET	2 ems
• BARLINES, HAIRLINES	1.5 pt, .5 pt
• SPACE BETWEEN HAIRLINES AND BOX END	2 spaces

090177e18ad97788\Final\Final On: 15-Dec-2016 01:34

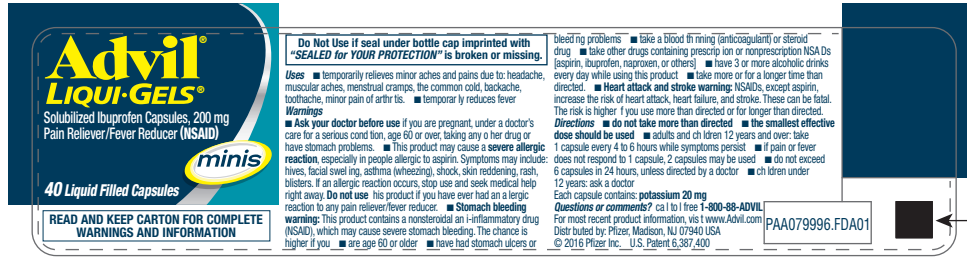

UNVARNISHED AND PRINTED IN BLACK OR DARK BLUE FOR LOT & EXPIRATION AREA.

3/16" X 3/16" DATA MATRIX CODE (ECC 200), PRINTED IN BLACK OR DARK BLUE ON UNPRINTED WHITE BACKGROUND.
DATA MATRIX CODE = 079996

PRODUCTION (NOT COLOR ACCURATE)

Job Information	Color Legend
Date 11-OCT-2016 PASS # 1 Component # PAA079996.FDA01 Drawing # DWG-00000435v02	(b) (4)
Identification	
Printer & User Notes	(b) (4)
PRINTER TO REPLACE ALL FPO CODES WITH SCANNABLE ART. PRINTER RESPONSIBLE FOR ALL TRAPPING, BLEEDS, COATINGS AND RESOLUTION. PRINTER AND USERS RESPONSIBLE FOR PROPER LICENSING OF ALL FONTS USED IN THIS ARTWORK.	
Vendor Identification	
Graphic Artist: (b) (4)	

DRUG FACTS TEXT DEFINED	TYPE SIZE
• HEADINGS	4.5 pt
• SUBHEADINGS/BODY TEXT	4.5 pt
• LEADING	4.5 pt
• BULLETS	3.5 pt
• SPACE BEFORE BULLET	2 ems
• WARNING BOX LINE, HAIRLINES	.5 pt

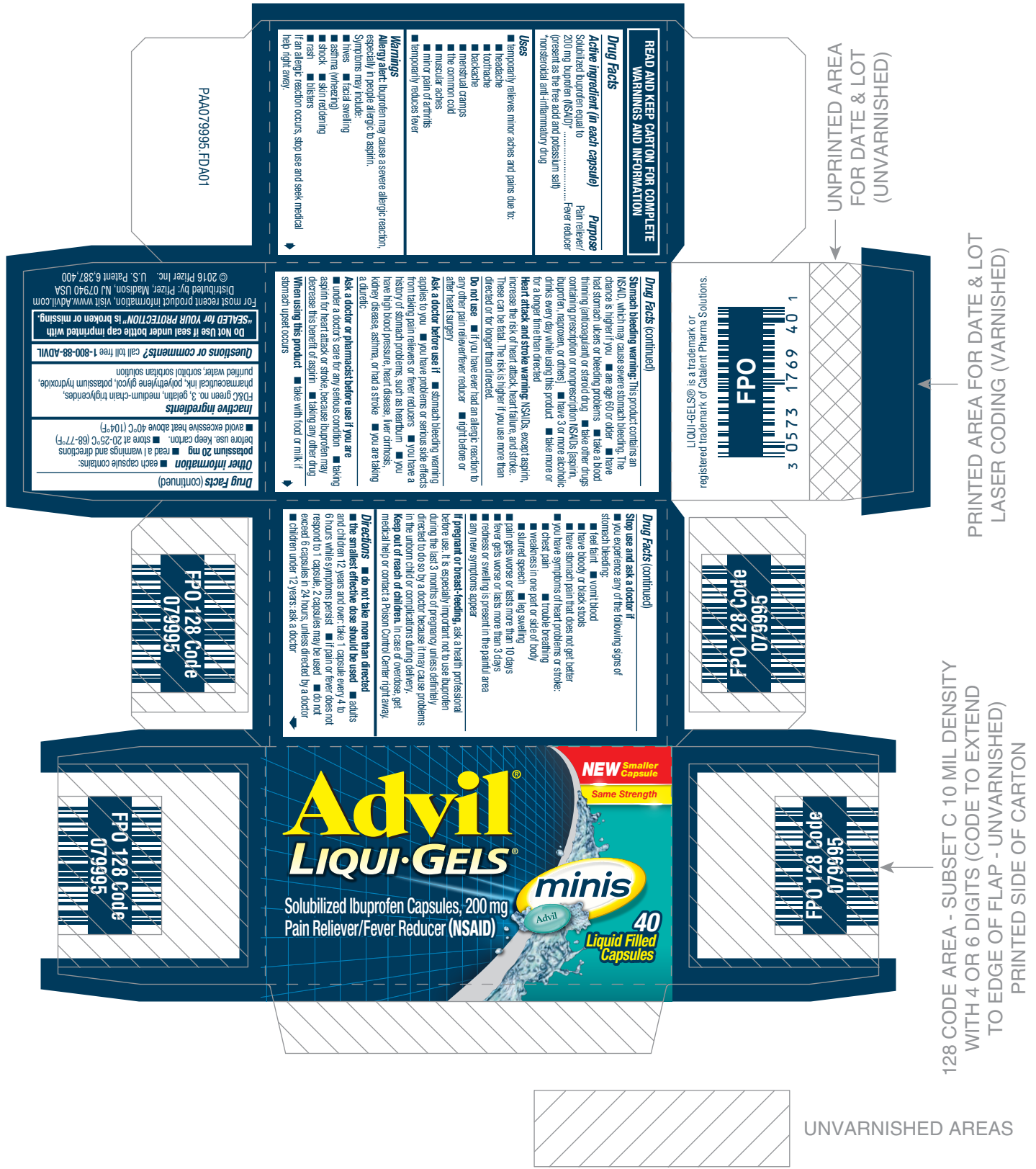

090177e18ad97787FinalFinal On: 15-Dec-2016 01:34

Silver Foil Stamp
Full size file on Silver Foil layer

Embossing - two levels
Full size file on Emboss layer

High Gloss Varnish and Matte Coating -
Full size file on Coating layers

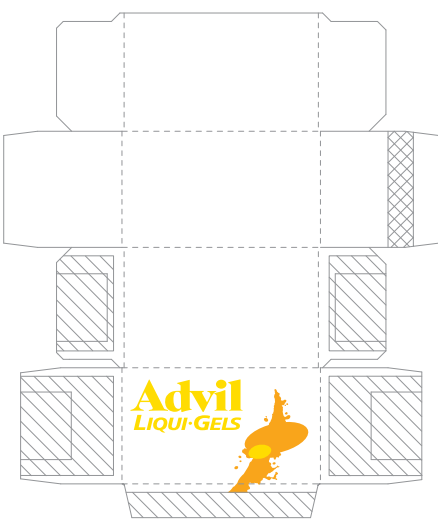
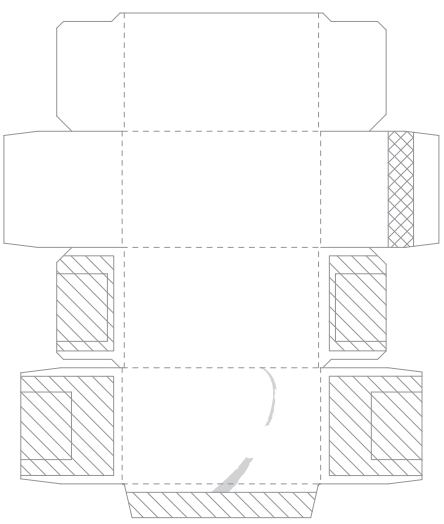

PRODUCTION

(NOT COLOR ACCURATE)

Job Information		Color Legend	
Date 11-OCT-2016	PASS # 1	(b) (4)	
Component #	PAA079995.FDA01		
Drawing #	DWG-00001119v04		
Identification			
Printer & User Notes			
PRINTER TO REPLACE ALL FPO CODES WITH SCANNABLE ART. PRINTER RESPONSIBLE FOR ALL TRAPPING, BLEEDS, COATINGS AND RESOLUTION. PRINTER AND USERS RESPONSIBLE FOR PROPER LICENSING OF ALL FONTS USED IN THIS ARTWORK.			
Vendor Identification			

DRUG FACTS MODIFIED TEXT DEFINED	TYPE SIZE
• DRUG FACTS TITLE	8 pt
• DRUG FACTS CONTINUED	7 pt
• HEADINGS	7 pt
• SUBHEADINGS/BODY TEXT	6 pt
• LEADING	6.25 pt
• # OF CHARACTERS PER INCH	<39
• BULLETS	5 pt
• SPACE BEFORE BULLET	2 ems
• BARLINES, HAIRLINES	1.5 pt, .5 pt
• SPACE BETWEEN HAIRLINES AND BOX END	2 spaces

Advil[®]
Liqui-Gels[®]
 Solubilized Ibuprofen Capsules, 200 mg
 Pain Reliever/Fever Reducer (NSAID)

minis

40 Liquid Filled Capsules

READ AND KEEP CARTON FOR COMPLETE WARNINGS AND INFORMATION

Do Not Use if seal under bottle cap imprinted with "SEALED for YOUR PROTECTION" is broken or missing.

Uses ■ temporarily relieves minor aches and pains due to: headache, muscular aches, menstrual cramps, the common cold, backache, toothache, minor pain of arthritis. ■ temporarily reduces fever

Warnings
 ■ **Ask your doctor before use** if you are pregnant, under a doctor's care for a serious condition, age 60 or over, taking any other drug or have stomach problems.
 ■ This product may cause a **severe allergic reaction**, especially in people allergic to aspirin. Symptoms may include: hives, facial swelling, asthma (wheezing), shock, skin reddening, rash, blisters. If an allergic reaction occurs, stop use and seek medical help right away. **Do not use** this product if you have ever had an allergic reaction to any pain reliever/fever reducer.
 ■ **Stomach bleeding warning:** This product contains a nonsteroidal anti-inflammatory drug (NSAID), which may cause severe stomach bleeding. The chance is higher if you ■ are age 60 or older ■ have had stomach ulcers or bleeding problems ■ take a blood thinning (anticoagulant) or steroid drug ■ take other drugs containing prescription or

nonprescription NSAIDs (aspirin, ibuprofen, naproxen, or others) ■ have 3 or more alcoholic drinks every day while using this product ■ take more or for a longer time than directed.
 ■ **Heart attack and stroke warning:** NSAIDs, except aspirin, increase the risk of heart attack, heart failure, and stroke. These can be fatal. The risk is higher if you use more than directed or for longer than directed.

Directions ■ **do not take more than directed** ■ **the smallest effective dose should be used** ■ adults and children 12 years and over: take 1 capsule every 4 to 6 hours while symptoms persist ■ if pain or fever does not respond to 1 capsule, 2 capsules may be used ■ do not exceed 6 capsules in 24 hours, unless directed by a doctor
 ■ children under 12 years: ask a doctor
 Each capsule contains: **potassium 20 mg**
Questions or comments? call toll free **1-800-88-ADVIL**
 For most recent product information, visit www.Advil.com
 Distributed by: Pfizer, Madison, NJ 07940 USA
 © 2016 Pfizer Inc. U.S. Patent 6,387,400

PAA079930.FDA01

3/16" X 3/16" DATA MATRIX CODE (ECC 200),
 PRINTED IN BLACK OR DARK BLUE
 ON UNPRINTED WHITE BACKGROUND.
DATA MATRIX CODE = 079930

UNVARNISHED AND PRINTED
 IN BLACK OR DARK BLUE.
 FOR LOT & EXPIRATION AREA

E:\8ad97786\Final\Final On: 15-Dec-2016 01:34

PRODUCTION

(NOT COLOR ACCURATE)

Job Information	Color Legend
Date 10-OCT-2016 PASS # 1 Component # PAA079930.FDA01 Drawing # DWG-00000433v01	(b) (4)
Identification	
Printer & User Notes	(b) (4)
PRINTER TO REPLACE ALL FPO CODES WITH SCANNABLE ART. PRINTER RESPONSIBLE FOR ALL TRAPPING, BLEEDS, COATINGS AND RESOLUTION. PRINTER AND USERS RESPONSIBLE FOR PROPER LICENSING OF ALL FONTS USED IN THIS ARTWORK.	
Vendor Identification	(b) (4)
Graphic Artist: (b) (4) Reference: 2	

DRUG FACTS TEXT DEFINED	TYPE SIZE
• HEADINGS	5.5 pt
• SUBHEADINGS/BODY TEXT	5.5 pt
• LEADING	6.0 pt
• BULLETS	4.5 pt
• SPACE BEFORE BULLET	2 ems
• WARNING BOX LINE, HAIRLINES	.5 pt



Specific Rule Legend

Cut _____
Crease - - - - -

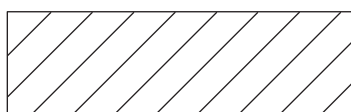

UNVARNISHED AREAS

PRINTED AREA FOR DATE & LOT
LASER CODING (VARNISHED)

UNPRINTED AREA
FOR DATE & LOT
(UNVARNISHED)

128 CODE AREA - SUBSET C 10 MIL DENSITY
WITH 4 OR 6 DIGITS (CODE TO EXTEND
TO EDGE OF FLAP - UNVARNISHED)
PRINTED SIDE OF CARTON

090177e18ad97785\Final\Final On: 15-Dec-2016 01:30

Silver Foil Stamp
Full size file on Silver Foil layer

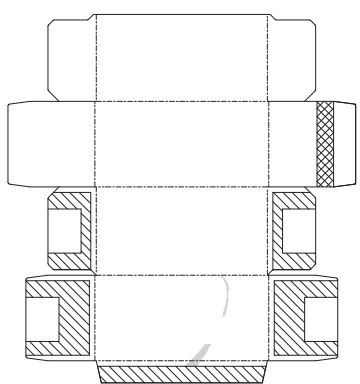

Embossing - two levels
Full size file on Emboss layer

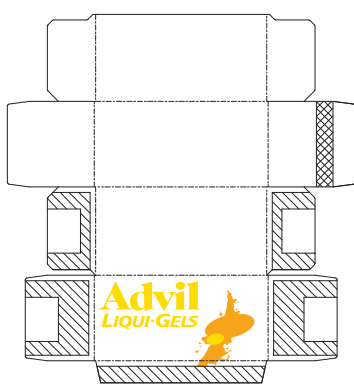

High Gloss Varnish and Matte Coating -
Full size file on Coating layers

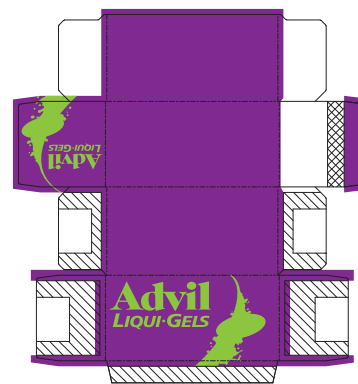

PRODUCTION

(NOT COLOR ACCURATE)

Job Information	Color Legend
Date 11-OCT-2016 PASS # 1 Component # PAA079929.FDA01 Drawing # DWG-00000432v04	(b) (4)
Identification	
Consumer Healthcare	(b) (4)
Printer & User Notes	
PRINTER TO REPLACE ALL FPO CODES WITH SCANNABLE ART.	
PRINTER RESPONSIBLE FOR ALL TRAPPING, BLEEDS, COATINGS AND RESOLUTION. PRINTER AND USERS RESPONSIBLE FOR PROPER LICENSING OF ALL FONTS USED IN THIS ARTWORK.	(b) (4)
Vendor Identification	
	(b) (4)

DRUG FACTS TEXT DEFINED	TYPE SIZE
• DRUG FACTS TITLE	9 pt
• DRUG FACTS CONTINUED	8 pt
• HEADINGS	8 pt
• SUBHEADINGS/BODY TEXT	6 pt
• LEADING	6.5 pt
• # OF CHARACTERS PER INCH	<39
• BULLETS	5 pt
• SPACE BEFORE BULLET	2 ems
• BARLINES, HAIRLINES	1.5 pt, .5 pt
• SPACE BETWEEN HAIRLINES AND BOX END	2 spaces

090177e189d24d16\Final\Final On: 14-Oct-2016 20:23

Do Not Use if seal under bottle cap imprinted with "SEALED for YOUR PROTECTION" is broken or missing.

Uses ■ temporarily relieves minor aches and pains due to: headache, muscular aches, menstrual cramps, the common cold, backache, toothache, minor pain of arthritis. ■ temporarily reduces fever

Warnings
 ■ **Ask your doctor before use** if you are pregnant, under a doctor's care for a serious condition, age 60 or over, taking any other drug or have stomach problems.
 ■ This product may cause a **severe allergic reaction**, especially in people allergic to aspirin. Symptoms may include: hives, facial swelling, asthma (wheezing), shock, skin reddening, rash, blisters. If an allergic reaction occurs, stop use and seek medical help right away.
Do not use this product if you have ever had an allergic reaction to any pain reliever/fever reducer.
 ■ **Stomach bleeding warning:** This product contains a nonsteroidal anti-inflammatory drug (NSAID), which may cause severe stomach bleeding. The chance is higher if you ■ are age 60 or older ■ have had stomach ulcers or bleeding problems ■ take a blood thinning (anticoagulant) or steroid drug ■ take other drugs containing prescription or nonprescription NSAIDs [aspirin, ibuprofen, naproxen, or others] ■ have 3 or more alcoholic drinks every day while using this product. ■ take more or for a longer time than directed.

Heart attack and stroke warning: NSAIDs, except aspirin, increase the risk of heart attack, heart failure, and stroke. These can be fatal. The risk is higher if you use more than directed or for longer than directed.

Directions ■ **do not take more than directed** ■ **the smallest effective dose should be used** ■ adults and children 12 years and over: take 1 capsule every 4 to 6 hours while symptoms persist ■ if pain or fever does not respond to 1 capsule, 2 capsules may be used ■ do not exceed 6 capsules in 24 hours, unless directed by a doctor ■ children under 12 years: ask a doctor
 Each capsule contains: **potassium 20 mg**

Questions or comments?
 call toll free **1-800-88-ADVIL**
 For most recent product information, visit www.Advil.com
 Distributed by:
 Pfizer, Madison, NJ 07940 USA
 © 2016 Pfizer Inc.
 U.S. Patent 6,387,400

PAA079998.FDA01

3/16" X 3/16" DATA MATRIX CODE (ECC 200),
 PRINTED IN BLACK OR DARK BLUE
 ON UNPRINTED WHITE BACKGROUND.
DATA MATRIX CODE = 079998

UNVARNISHED AND PRINTED
 IN BLACK OR DARK BLUE.
 FOR LOT & EXPIRATION AREA

PRODUCTION (NOT COLOR ACCURATE)

Job Information	Color Legend
Date 07-OCT-2016 PASS # 1 Component # PAA079998.FDA01 Drawing # DWG-00000433v01	(b) (4)
Identification	
(b) (4)	Printer & User Notes PRINTER TO REPLACE ALL FPO CODES WITH SCANNABLE ART. PRINTER RESPONSIBLE FOR ALL TRAPPING, BLEEDS, COATINGS AND RESOLUTION. PRINTER AND USERS RESPONSIBLE FOR PROPER LICENSING OF ALL FONTS USED IN THIS ARTWORK.
Vendor Identification	
(b) (4)	
Graphic Artist: (b) (4)	

DRUG FACTS TEXT DEFINED	TYPE SIZE
• HEADINGS	5.35 pt
• SUBHEADINGS/BODY TEXT	5.35 pt
• LEADING	5.85 pt
• BULLETS	4.35 pt
• SPACE BEFORE BULLET	2 ems
• WARNING BOX LINE, HAIRLINES	.5 pt



128 CODE AREA - SUBSET C, 10 MIL DENSITY WITH 4 OR 6 DIGITS CODE TO EXTEND TO EDGE OF FLAP (UNVARNISHED)-PRINTED SIDE OF CARTON

Silver Foil Stamp
Full size file on Silver Foil layer

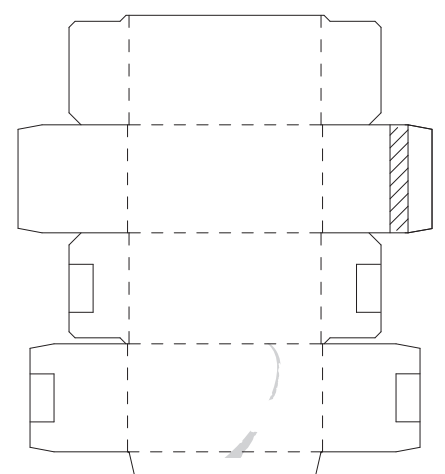

Embossing - two levels
Full size file on Emboss layer

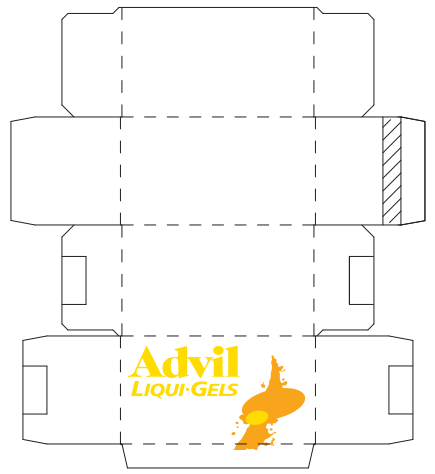

High Gloss Varnish and Matte Coating -
Full size file on Coating layers

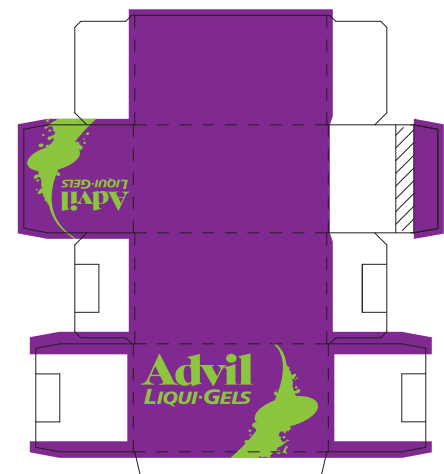

PRODUCTION

(NOT COLOR ACCURATE)

Job Information	
Date	11-OCT-2016 PASS # 1
Component #	PAA079997.FDA01
Drawing #	DWG-00000431v01
Identification	
(b) (4)	
Vendor Identification	
(b) (4)	

Color Legend	
(b) (4)	
Printer & User Notes	
PRINTER TO REPLACE ALL FPO CODES WITH SCANNABLE ART.	
PRINTER RESPONSIBLE FOR ALL TRAPPING, BLEEDS, COATINGS AND RESOLUTION.	
PRINTER AND USERS RESPONSIBLE FOR PROPER LICENSING OF ALL FONTS USED IN THIS ARTWORK.	

DRUG FACTS TEXT DEFINED	TYPE SIZE
• DRUG FACTS TITLE	9 pt
• DRUG FACTS CONTINUED	8 pt
• HEADINGS	8 pt
• SUBHEADINGS/BODY TEXT	6 pt
• LEADING	6.5 pt
• # OF CHARACTERS PER INCH	<39
• BULLETS	5 pt
• SPACE BEFORE BULLET	2 ems
• BARLINES, HAIRLINES	1.5 pt, .5 pt
• SPACE BETWEEN HAIRLINES AND BOX END	2 spaces

090177e18ad9778c\Final\Final On: 15-Dec-2016 01:31

Do Not Use if seal under bottle cap imprinted with "SEALED for YOUR PROTECTION" is broken or missing.

Uses ■ temporarily relieves minor aches and pains due to: headache, muscular aches, menstrual cramps, the common cold, backache, toothache, minor pain of arthritis. ■ temporarily reduces fever

Warnings
 ■ **Ask your doctor before use** if you are pregnant, under a doctor's care for a serious condition, age 60 or over, taking any other drug or have stomach problems.
 ■ This product may cause a **severe allergic reaction**, especially in people allergic to aspirin. Symptoms may include: hives, facial swelling, asthma (wheezing), shock, skin reddening, rash, blisters. If an allergic reaction occurs, stop use and seek medical help right away. **Do not use** this product if you have ever had an allergic reaction to any pain reliever/fever reducer.
 ■ **Stomach bleeding warning:** This product contains a nonsteroidal anti-inflammatory drug (NSAID), which may cause severe stomach bleeding. The chance is higher if you ■ are age 60 or older ■ have had stomach ulcers or bleeding problems ■ take a blood thinning (anticoagulant) or steroid drug ■ take other drugs containing prescription or nonprescription NSAIDs [aspirin, ibuprofen, naproxen, or others] ■ have 3 or more alcoholic drinks every day while using this product ■ take more or for a longer time than directed.

Heart attack and stroke warning: NSAIDs, except aspirin, increase the risk of heart attack, heart failure, and stroke. These can be fatal. The risk is higher if you use more than directed or for longer than directed.

Directions ■ **do not take more than directed** ■ **the smallest effective dose should be used** ■ adults and children 12 years and over: take 1 capsule every 4 to 6 hours while symptoms persist ■ if pain or fever does not respond to 1 capsule, 2 capsules may be used ■ do not exceed 6 capsules in 24 hours, unless directed by a doctor ■ children under 12 years: ask a doctor

Each capsule contains: **potassium 20 mg**

Questions or comments?
 call toll free **1-800-88-ADVIL**
 For most recent product information, visit www.Advil.com
 Distributed by: Pfizer, Madison, NJ 07940 USA
 © 2016 Pfizer Inc.
 U.S. Patent 6,387,400

PAA080002.FDA01

3/16" X 3/16" DATA MATRIX CODE (ECC 200), PRINTED IN BLACK OR DARK BLUE ON UNPRINTED WHITE BACKGROUND.
DATA MATRIX CODE = 080002

UNVARNISHED AND PRINTED IN BLACK OR DARK BLUE FOR LOT & EXPIRATION AREA.

PRODUCTION (NOT COLOR ACCURATE)

Job Information	Color Legend
Date 07-OCT-2016 PASS # 1 Component # PAA080002.FDA01 Drawing # DWG-00000507v02	(b) (4)
Identification 	
Printer & User Notes PRINTER TO REPLACE ALL FPO CODES WITH SCANNABLE ART. PRINTER RESPONSIBLE FOR ALL TRAPPING, BLEEDS, COATINGS AND RESOLUTION. PRINTER AND USERS RESPONSIBLE FOR PROPER LICENSING OF ALL FONTS USED IN THIS ARTWORK.	
Vendor Identification	(b) (4)

DRUG FACTS TEXT DEFINED	TYPE SIZE
• HEADINGS	5.5 pt
• SUBHEADINGS/BODY TEXT	5.5 pt
• LEADING	6 pt
• BULLETS	4.5 pt
• SPACE BEFORE BULLET	2 ems
• WARNING BOX LINE, HAIRLINES	.5 pt



128 CODE AREA - SUBSET C, 10 MIL DENSITY WITH 4 OR 6 DIGITS (CODE TO EXTEND TO EDGE OF FLAP (UNVARNISHED)-PRINTED SIDE OF CARTON

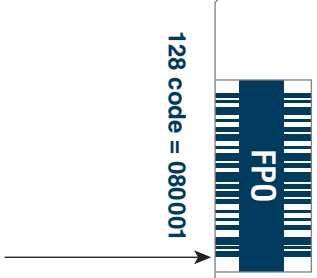

Silver Foil Stamp
Full size file on Silver Foil layer

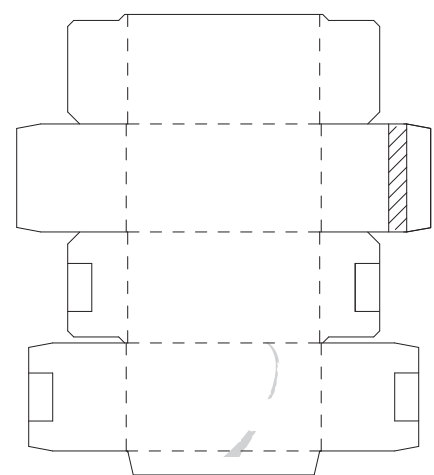

Embossing - two levels
Full size file on Emboss layer

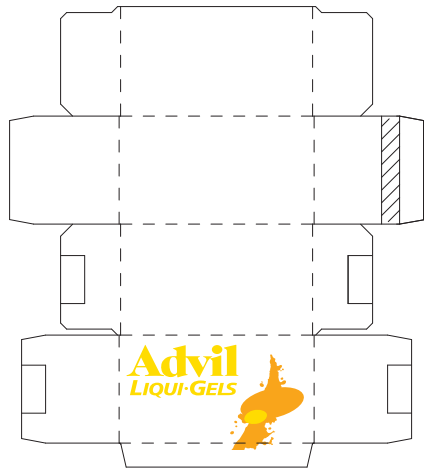

High Gloss Varnish and Matte Coating -
Full size file on Coating layers

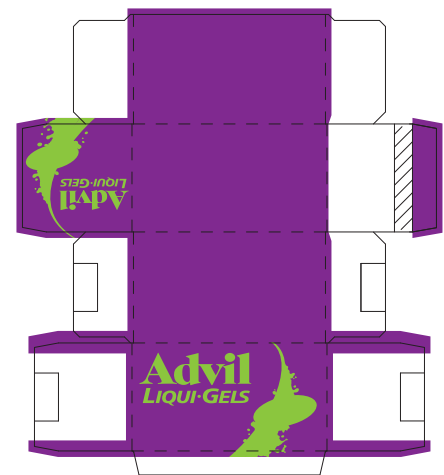

PRODUCTION

(NOT COLOR ACCURATE)

Job Information	Color Legend
Date 10-OCT-2016 PASS # 1 Component # PAA080001.FDA01 Drawing # DWG-00000431 v01	(b) (4)
Identification	
(b) (4)	
Printer & User Notes	
PRINTER TO REPLACE ALL FPO CODES WITH SCANNABLE ART. PRINTER RESPONSIBLE FOR ALL TRAPPING, BLEEDS, COATINGS AND RESOLUTION. PRINTER AND USERS RESPONSIBLE FOR PROPER LICENSING OF ALL FONTS USED IN THIS ARTWORK.	

DRUG FACTS TEXT DEFINED	TYPE SIZE
• DRUG FACTS TITLE	9 pt
• DRUG FACTS CONTINUED	8 pt
• HEADINGS	8 pt
• SUBHEADINGS/BODY TEXT	6 pt
• LEADING	6.5 pt
• # OF CHARACTERS PER INCH	<39
• BULLETS	5 pt
• SPACE BEFORE BULLET	2 ems
• BARLINES, HAIRLINES	1.5 pt, .5 pt
• SPACE BETWEEN HAIRLINES AND BOX END	2 spaces

090177e18ad9778a\Final\Final On: 15-Dec-2016 01:33

Advil[®]
LIQUI-GELS[®]
 Solubilized Ibuprofen Capsules, 200 mg
 Pain Reliever/Fever Reducer (NSAID)
minis
 160 Liquid Filled Capsules

READ AND KEEP CARTON FOR COMPLETE WARNINGS AND INFORMATION

Do Not Use if seal under bottle cap imprinted with "SEALED for YOUR PROTECTION" is broken or missing.

Uses

temporarily relieves minor aches and pains due to: headache, muscular aches, menstrual cramps, the common cold, backache, toothache, minor pain of arthritis.

temporarily reduces fever

Warnings

Ask your doctor before use if you are pregnant, under a doctor's care for a serious condition, age 60 or over, taking any other drug or have stomach problems.

This product may cause a **severe allergic reaction**, especially in people allergic to aspirin. Symptoms may include: hives, facial swelling, asthma (wheezing), shock, skin reddening, rash, blisters. If an allergic reaction occurs, stop use and seek medical help right away. **Do not use** this product if you have ever had an allergic reaction to any pain reliever/fever reducer.

Stomach bleeding warning: This product contains a nonsteroidal anti-inflammatory drug (NSAID), which may cause severe stomach bleeding. The chance is higher if you are age 60 or older have had stomach ulcers or bleeding problems take a blood thinning (anticoagulant) or steroid drug take other drugs containing prescription

or nonprescription NSAIDs [aspirin, ibuprofen, naproxen, or others] have 3 or more alcoholic drinks every day while using this product take more or for a longer time than directed.

Heart attack and stroke warning: NSAIDs, except aspirin, increase the risk of heart attack, heart failure, and stroke. These can be fatal. The risk is higher if you use more than directed or for longer than directed.

Directions do not take more than directed the smallest effective dose should be used adults and children 12 years and over: take 1 capsule every 4 to 6 hours while symptoms persist if pain or fever does not respond to 1 capsule, 2 capsules may be used do not exceed 6 capsules in 24 hours, unless directed by a doctor

children under 12 years: ask a doctor Each capsule contains: **potassium 20 mg**

Questions or comments? call toll free **1-800-88-ADVIL**

For most recent product information, visit www.Advil.com
 Distributed by: Pfizer, Madison, NJ 07940 USA
 © 2016 Pfizer Inc. U.S. Patent 6,387,400

PAA080000.FDA01



3/16" X 3/16" DATA MATRIX CODE (ECC 200), PRINTED IN BLACK OR DARK BLUE ON UNPRINTED WHITE BACKGROUND. DATA MATRIX CODE = 080000

UNVARNISHED AND PRINTED IN BLACK OR DARK BLUE FOR LOT & EXPIRATION AREA.

PRODUCTION

(NOT COLOR ACCURATE)

Job Information	Color Legend
Date 07-OCT-2016 PASS # 1 Component # PAA080000.FDA01 Drawing # DWG-00000506v02	(b) (4)
Identification	
Printer & User Notes	(b) (4)
PRINTER TO REPLACE ALL FPO CODES WITH SCANNABLE ART. PRINTER RESPONSIBLE FOR ALL TRAPPING, BLEEDS, COATINGS AND RESOLUTION. PRINTER AND USERS RESPONSIBLE FOR PROPER LICENSING OF ALL FONTS USED IN THIS ARTWORK.	
Vendor Identification	(b) (4)
(b) (4)	

DRUG FACTS TEXT DEFINED	TYPE SIZE
• HEADINGS	6 pt
• SUBHEADINGS/BODY TEXT	6 pt
• LEADING	6.5 pt
• BULLETS	5 pt
• SPACE BEFORE BULLET	2 ems
• WARNING BOX LINE, HAIRLINES	.5 pt

**TOP
PANEL 1**

NO COPY 1/16" (0.0625") FROM DIE.
DOTTED LINE FOR HOLDING ONLY
AND DOES NOT PRINT.

KISS CUT

ART BLEEDS OFF 1/16" (0.0625")
OUT FROM DIE. DOTTED LINE FOR
HOLDING ONLY AND DOES NOT PRINT.

THIS LINE INDICATES DIE
AND DOES NOT PRINT.

3/16" X 3/16" DATA MATRIX CODE (ECC 200),
PRINTED IN BLACK OR DARK BLUE ON
UNPRINTED WHITE BACKGROUND.
DATA MATRIX CODE = 080004

FOR LOT & EXPIRATION AREA.
UNVARNISHED AND PRINTED
IN BLACK OR DARK BLUE. (b) (4)

**BASE
PANEL 3**

3/8" HINGE AREA
UNVARNISHED
(LINES DO NOT PRINT)

ART BLEEDS OFF 1/16" (0.0625")
OUT FROM DIE. DOTTED LINE FOR
HOLDING ONLY AND DOES NOT PRINT.

THIS LINE INDICATES DIE
AND DOES NOT PRINT.

NO COPY 1/16" (0.0625") FROM DIE.
DOTTED LINE FOR HOLDING ONLY
AND DOES NOT PRINT. (b) (4)

**RELEASED BACK
PANEL 2**

3/8" HINGE AREA
UNVARNISHED
(LINES DO NOT PRINT)

ART BLEEDS OFF 1/16" (0.0625")
OUT FROM DIE. DOTTED LINE FOR
HOLDING ONLY AND DOES NOT PRINT.

THIS LINE INDICATES DIE
AND DOES NOT PRINT.

NO COPY 1/16" (0.0625") FROM DIE.
DOTTED LINE FOR HOLDING ONLY
AND DOES NOT PRINT. (b) (4)

Silver Foil Stamp
Full size file on Silver Foil layer

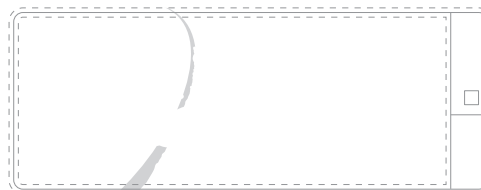

090177e18ad97e06\Final\Final On: 15-Dec-2016 01:30

PRODUCTION

(NOT COLOR ACCURATE)

Job Information	Color Legend
Date 14-OCT-2016 PASS # 2 Component # PAA080004.FDA01 Drawing # DWG-50031908v02	SEE ARTWORK FOR COLOR
Identification 	
Printer & User Notes PRINTER TO REPLACE ALL FPO CODES WITH SCANNABLE ART. PRINTER RESPONSIBLE FOR ALL TRAPPING, BLEEDS, COATINGS AND RESOLUTION. PRINTER AND USERS RESPONSIBLE FOR PROPER LICENSING OF ALL FONTS USED IN THIS ARTWORK.	
Vendor Identification	

DRUG FACTS TEXT DEFINED	TYPE SIZE
• DRUG FACTS TITLE	9 pt
• DRUG FACTS CONTINUED	8 pt
• HEADINGS	8 pt
• SUBHEADINGS/BODY TEXT	6 pt
• LEADING	6.5 pt
• # OF CHARACTERS PER INCH	<39
• BULLETS	5 pt
• SPACE BEFORE BULLET	2 ems
• BARLINES, HAIRLINES	1.5 pt, .5 pt
• SPACE BETWEEN HAIRLINES AND BOX END	2 spaces

TOP PANEL 1

NO COPY 1/16" (0.0625") FROM DIE. DOTTED LINE FOR HOLDING ONLY AND DOES NOT PRINT.

KISS CUT

Easy Open ARTHRITIS CAP
Arthritis Foundation Ease of Use CAP
NEW Smaller Capsule
Same Strength

THIS PACKAGE FOR HOUSEHOLDS WITHOUT YOUNG CHILDREN

Advil LIQUI-GELS minis
Solubilized Ibuprofen Capsules, 200 mg Pain Reliever/Fever Reducer (NSAID)
160 Liquid Filled Capsules

Do Not Use if seal under bottle cap imprinted with "SEALED for YOUR PROTECTION" is broken or missing.

Drug Facts
Active ingredient (in each capsule) Purpose
Solubilized ibuprofen equal to 200 mg ibuprofen (NSAID)* Pain reliever/Fever reducer (present as the free acid and potassium salt) (nonsteroidal anti-inflammatory drug)

Uses
temporarily relieves minor aches and pains due to:
 ■ headache
 ■ toothache
 ■ backache
 ■ menstrual cramps
 ■ the common cold
 ■ muscular aches
 ■ minor pain of arthritis
 ■ temporarily reduces fever

PAA080003.FDA01

LIFT HERE for more Drug Facts

ART BLEEDS OFF 1/16" (0.0625") OUT FROM DIE. DOTTED LINE FOR HOLDING ONLY AND DOES NOT PRINT.

THIS LINE INDICATES DIE AND DOES NOT PRINT.

3/16" X 3/16" DATA MATRIX CODE (ECC 200), PRINTED IN BLACK OR DARK BLUE ON UNPRINTED WHITE BACKGROUND. DATA MATRIX CODE = 080003

(b) (4)

FOR LOT & EXPIRATION AREA. UNVARNISHED AND PRINTED IN BLACK OR DARK BLUE.

BASE PANEL 3

3/8" HINGE AREA UNVARNISHED (LINES DO NOT PRINT)

Drug Facts (continued)
If pregnant or breast-feeding, ask a health professional before use. It is especially important not to use ibuprofen during the last 3 months of pregnancy unless definitely directed to do so by a doctor because it may cause problems in the unborn child or complications during delivery.
Keep out of reach of children. In case of overdose, get medical help or contact a Poison Control Center right away.

Directions
 ■ do not take more than directed
 ■ the smallest effective dose should be used
 ■ adults and children 12 years and over: take 1 capsule every 4 to 6 hours while symptoms persist
 ■ if pain or fever does not respond to 1 capsule, 2 capsules may be used
 ■ do not exceed 6 capsules in 24 hours, unless directed by a doctor
 ■ children under 12 years: ask a doctor

Other information
 ■ each capsule contains: potassium 20 mg
 ■ read all warnings and directions before use.
 ■ store at 20-25°C (68-77°F)
 ■ avoid excessive heat above 40°C (104°F)

Inactive ingredients
FD&C green no. 3, gelatin, medium-chain triglycerides, pharmaceutical ink, polyethylene glycol, potassium hydroxide, purified water, sorbitol sorbitan solution

Questions or comments?
call toll free 1-800-88-ADVIL

Advil

Distributed by: Pfizer, Madison, NJ 07940 USA
© 2016 Pfizer Inc.
For most recent product information, visit www.Advil.com

LIQUI-GELS® is a trademark or registered trademark of Catalent Pharma Solutions.
U.S. Patent 6,387,400

ART BLEEDS OFF 1/16" (0.0625") OUT FROM DIE. DOTTED LINE FOR HOLDING ONLY AND DOES NOT PRINT.

THIS LINE INDICATES DIE AND DOES NOT PRINT.

NO COPY 1/16" (0.0625") FROM DIE. DOTTED LINE FOR HOLDING ONLY AND DOES NOT PRINT.

(b) (4)

RELEASED BACK PANEL 2

3/8" HINGE AREA UNVARNISHED (LINES DO NOT PRINT)

Drug Facts (continued)
Warnings
Allergy alert: Ibuprofen may cause a severe allergic reaction, especially in people allergic to aspirin. Symptoms may include:
 ■ hives
 ■ facial swelling
 ■ asthma (wheezing)
 ■ shock ■ skin reddening
 ■ rash ■ blisters
 If an allergic reaction occurs, stop use and seek medical help right away.
Stomach bleeding warning: This product contains an NSAID, which may cause severe stomach bleeding. The chance is higher if you
 ■ are age 60 or older
 ■ have had stomach ulcers or bleeding problems
 ■ take a blood thinning (anticoagulant) or steroid drug
 ■ take other drugs containing prescription or nonprescription NSAIDs [aspirin, ibuprofen, naproxen, or others]
 ■ have 3 or more alcoholic drinks every day while using this product
 ■ take more or for a longer time than directed
Heart attack and stroke warning: NSAIDs, except aspirin, increase the risk of heart attack, heart failure, and stroke. These can be fatal. The risk is higher if you use more than directed or for longer than directed.
Do not use
 ■ if you have ever had an allergic reaction to any other pain reliever/fever reducer
 ■ right before or after heart surgery

Drug Facts (continued)
Ask a doctor before use if
 ■ stomach bleeding warning applies to you
 ■ you have problems or serious side effects from taking pain relievers or fever reducers
 ■ you have a history of stomach problems, such as heartburn
 ■ you have high blood pressure, heart disease, liver cirrhosis, kidney disease, asthma, or had a stroke
 ■ you are taking a diuretic
Ask a doctor or pharmacist before use if you are
 ■ under a doctor's care for any serious condition
 ■ taking aspirin for heart attack or stroke, because ibuprofen may decrease this benefit of aspirin
 ■ taking any other drug
When using this product ■ take with food or milk if stomach upset occurs
Stop use and ask a doctor if
 ■ you experience any of the following signs of stomach bleeding:
 ■ feel faint ■ vomit blood ■ have bloody or black stools
 ■ have stomach pain that does not get better
 ■ you have symptoms of heart problems or stroke:
 ■ chest pain ■ trouble breathing
 ■ weakness in one part or side of body
 ■ slurred speech ■ leg swelling
 ■ pain gets worse or lasts more than 10 days
 ■ fever gets worse or lasts more than 3 days
 ■ redness or swelling is present in the painful area
 ■ any new symptoms appear

ART BLEEDS OFF 1/16" (0.0625") OUT FROM DIE. DOTTED LINE FOR HOLDING ONLY AND DOES NOT PRINT.

THIS LINE INDICATES DIE AND DOES NOT PRINT.

NO COPY 1/16" (0.0625") FROM DIE. DOTTED LINE FOR HOLDING ONLY AND DOES NOT PRINT.

(b) (4)

PRODUCTION

(NOT COLOR ACCURATE)

Job Information	Color Legend
Date 11-OCT-2016 PASS # 1 Component # PAA080003.FDA01 Drawing # DWG-50031909 v02	SEE ARTWORK FOR COLOR
Identification Pfizer Consumer Healthcare	
Printer & User Notes	Printer to replace all FPO codes with scannable art.
Vendor Identification	Printer responsible for all trapping, bleeds, coatings and resolution. Printer and users responsible for proper licensing of all fonts used in this artwork.

DRUG FACTS MODIFIED TEXT DEFINED	TYPE SIZE
• DRUG FACTS TITLE	9 pt
• DRUG FACTS CONTINUED	8 pt
• HEADINGS	8 pt
• SUBHEADINGS/BODY TEXT	6 pt
• LEADING	6.5 pt
• # OF CHARACTERS PER INCH	<39
• BULLETS	5 pt
• SPACE BEFORE BULLET	2 ems
• BARLINES, HAIRLINES	1.5 pt, .5 pt
• SPACE BETWEEN HAIRLINES AND BOX END	2 spaces

Silver Foil Stamp
Full size file on Silver Foil layer
Must open file with Illustrator
TOP PANEL 1



Printer Notes:
FPO Silver Foil is only representative of Foil Stamp. Do not separate or print.

TOP LAYER FACE

TOP LAYER BACK

BASE LAYER

Silver Foil Stamp
Full size file on Silver Foil layer



090177e189d24c1e\Final\Final On: 14-Oct-2016 20:49

PRODUCTION

(NOT COLOR ACCURATE)

Job Information	Color Legend
Date 11-OCT-2016 PASS # 1 Component # PAA080005.FDA01 Drawing # DWG-00000430v02	(b) (4)
Identification Consumer Healthcare	(b) (4)
Printer & User Notes PRINTER TO REPLACE ALL FPO CODES WITH SCANNABLE ART. PRINTER RESPONSIBLE FOR ALL TRAPPING, VARNISH, BLEEDS AND RESOLUTION. PRINTER AND USERS RESPONSIBLE FOR PROPER LICENSING OF ALL FONTS USED IN THIS ARTWORK.	(b) (4)
Vendor Identification	(b) (4)

DRUG FACTS MODIFIED TEXT DEFINED	TYPE SIZE
• DRUG FACTS TITLE	9 pt
• DRUG FACTS CONTINUED	8 pt
• HEADINGS	8 pt
• SUBHEADINGS/BODY TEXT	6 pt
• LEADING	6.5 pt
• # OF CHARACTERS PER INCH	<39
• BULLETS	5 pt
• SPACE BEFORE BULLET	2 ems
• BARLINES, HAIRLINES	1.5 pt, .5 pt
• SPACE BETWEEN HAIRLINES AND BOX END	2 spaces

090177e189d24c20\Final\Final On: 14-Oct-2016 20:56

Advil[®]
LIQUI-GELS[®]
 Solubilized Ibuprofen Capsules, 200 mg
 Pain Reliever/Fever Reducer (NSAID)
minis
 120 Liquid Filled Capsules

READ AND KEEP CARTON FOR COMPLETE WARNINGS AND INFORMATION

Do Not Use if seal under bottle cap imprinted with "SEALED for YOUR PROTECTION" is broken or missing.

Uses
 ■ temporarily relieves minor aches and pains due to: headache, muscular aches, menstrual cramps, the common cold, backache, toothache, minor pain of arthritis.
 ■ temporarily reduces fever

Warnings
 ■ **Ask your doctor before use** if you are pregnant, under a doctor's care for a serious condition, age 60 or over, taking any other drug or have stomach problems.
 ■ This product may cause a **severe allergic reaction**, especially in people allergic to aspirin. Symptoms may include: hives, facial swelling, asthma (wheezing), shock, skin reddening, rash, blisters. If an allergic reaction occurs, stop use and seek medical help right away. **Do not use** this product if you have ever had an allergic reaction to any pain reliever/fever reducer.
 ■ **Stomach bleeding warning:** This product contains a nonsteroidal anti-inflammatory drug (NSAID), which may cause severe stomach bleeding. The chance is higher if you ■ are age 60 or older ■ have had stomach ulcers or bleeding problems ■ take a blood thinning (anticoagulant) or steroid drug ■ take other drugs containing prescription

or nonprescription NSAIDs [aspirin, ibuprofen, naproxen, or others] ■ have 3 or more alcoholic drinks every day while using this product ■ take more or for a longer time than directed.

■ **Heart attack and stroke warning:** NSAIDs, except aspirin, increase the risk of heart attack, heart failure, and stroke. These can be fatal. The risk is higher if you use more than directed or for longer than directed.

Directions ■ **do not take more than directed** ■ **the smallest effective dose should be used** ■ adults and children 12 years and over: take 1 capsule every 4 to 6 hours while symptoms persist ■ if pain or fever does not respond to 1 capsule, 2 capsules may be used ■ do not exceed 6 capsules in 24 hours, unless directed by a doctor
 ■ children under 12 years: ask a doctor
 Each capsule contains: **potassium 20 mg**

Questions or comments?
 call toll free **1-800-88-ADVIL**
 For most recent product information, visit www.Advil.com
 Distributed by: Pfizer, Madison, NJ 07940 USA
 © 2016 Pfizer Inc. U.S. Patent 6,387,400

PAA080007.FDA01



3/16" X 3/16" DATA MATRIX CODE (ECC 200), PRINTED IN BLACK OR DARK BLUE ON UNPRINTED WHITE BACKGROUND. DATA MATRIX CODE = 080007

UNVARNISHED AND PRINTED IN BLACK OR DARK BLUE FOR LOT & EXPIRATION AREA.

PRODUCTION

(NOT COLOR ACCURATE)

Job Information	Color Legend
Date 11-OCT-2016 PASS # 1 Component # PAA080007.FDA01 Drawing # DWG-00000506v02	(b) (4)
Identification 	
Printer & User Notes PRINTER TO REPLACE ALL FPO CODES WITH SCANNABLE ART. PRINTER RESPONSIBLE FOR ALL TRAPPING, BLEEDS, COATINGS AND RESOLUTION. PRINTER AND USERS RESPONSIBLE FOR PROPER LICENSING OF ALL FONTS USED IN THIS ARTWORK.	
Vendor Identification	

DRUG FACTS TEXT DEFINED	TYPE SIZE
• HEADINGS	6 pt
• SUBHEADINGS/BODY TEXT	6 pt
• LEADING	6.5 pt
• BULLETS	5 pt
• SPACE BEFORE BULLET	2 ems
• WARNING BOX LINE, HAIRLINES	.5 pt

TOP LAYER FACE

TOP LAYER BACK

BASE LAYER

Silver Foil Stamp
Full size file on Silver Foil layer



090177e189d24c24\Final\Final On: 14-Oct-2016 21:00

PRODUCTION

(NOT COLOR ACCURATE)

Job Information	Color Legend
Date 12-OCT-2016 PASS # 1 Component # PAA080008.FDA01 Drawing # DWG-00000430v02	(b) (4)
Identification Pfizer Consumer Healthcare	(b) (4)
Vendor Identification	(b) (4)
Printer & User Notes PRINTER TO REPLACE ALL FPO CODES WITH SCANNABLE ART. PRINTER RESPONSIBLE FOR ALL TRAPPING, VARNISH, BLEEDS AND RESOLUTION. PRINTER AND USERS RESPONSIBLE FOR PROPER LICENSING OF ALL FONTS USED IN THIS ARTWORK.	

DRUG FACTS MODIFIED TEXT DEFINED	TYPE SIZE
• DRUG FACTS TITLE	9 pt
• DRUG FACTS CONTINUED	8 pt
• HEADINGS	8 pt
• SUBHEADINGS/BODY TEXT	6 pt
• LEADING	6.5 pt
• # OF CHARACTERS PER INCH	<39
• BULLETS	5 pt
• SPACE BEFORE BULLET	2 ems
• BARLINES, HAIRLINES	1.5 pt, .5 pt
• SPACE BETWEEN HAIRLINES AND BOX END	2 spaces

128 CODE = 080006



NO VARNISH - GLUE AREA

128 CODE AREA - SUBSET C 10 MIL DENSITY WITH 4 OR 6 DIGITS (CODE TO EXTEND TO EDGE OF FLAP) - UNVARNISHED - PRINTED SIDE OF CARTON

128 CODE = 080006



2 PACK
2x120 Count



2 PACK
2x120 Count



2 PACK
2x120 Count



READ AND KEEP CARTON FOR COMPLETE WARNINGS AND INFORMATION

Drug Facts

Active ingredient (in each capsule)
Solubilized ibuprofen equal to 200 mg ibuprofen (NSAID)
(present as the free acid and potassium salt)
*nonsteroidal anti-inflammatory drug

Purpose

Pain reliever/fever reducer

Uses

- temporarily relieves minor aches and pains due to:
 - headache
 - toothache
 - backache
 - menstrual cramps
 - the common cold
 - muscular aches
 - minor pain of arthritis
- temporarily reduces fever

Warnings

- Allergy alert:** Ibuprofen may cause a severe allergic reaction, especially in people allergic to aspirin. Symptoms may include:
 - hives
 - facial swelling
 - asthma (wheezing)
 - shock
 - skin reddening
 - rash
 - blisters
- If an allergic reaction occurs, stop use and seek medical help right away.
- Stomach bleeding warning:** This product contains an NSAID, which may cause severe stomach bleeding. The chance is higher if you
 - are age 60 or older
 - have had stomach ulcers or bleeding problems
 - take a blood thinning (anticoagulant) or steroid drug
 - take other drugs containing prescription or nonprescription NSAIDs (aspirin, ibuprofen, naproxen, or others)
 - have 3 or more alcoholic drinks every day while using this product
 - take more or for a longer time than directed
- Heart attack and stroke warning:** NSAIDs, except aspirin, increase the risk of heart attack, heart failure, and stroke. These can be fatal. The risk is higher if you use more than directed or for longer than directed.

Do not use

- if you have ever had an allergic reaction to any other pain reliever/fever reducer
- right before or after heart surgery

Ask a doctor before use if

- stomach bleeding warning applies to you
- you have problems or serious side effects from taking pain relievers or fever reducers
- you have a history of stomach problems, such as heartburn

Drug Facts (continued)

- you have high blood pressure, heart disease, liver cirrhosis, kidney disease, asthma, or had a stroke
- you are taking a diuretic

Ask a doctor or pharmacist before use if you are

- under a doctor's care for any serious condition
- taking aspirin for heart attack or stroke, because ibuprofen may decrease this benefit of aspirin
- taking any other drug

When using this product

- take with food or milk if stomach upset occurs

Stop use and ask a doctor if

- you experience any of the following signs of stomach bleeding:
 - feel faint
 - vomit blood
 - have bloody or black stools
 - have stomach pain that does not get better
- you have symptoms of heart problems or stroke:
 - chest pain
 - trouble breathing
 - weakness in one part or side of body
 - slurred speech
 - leg swelling
- pain gets worse or lasts more than 10 days
- fever gets worse or lasts more than 3 days
- redness or swelling is present in the painful area
- any new symptoms appear

If pregnant or breast-feeding, ask a health professional before use. It is especially important not to use ibuprofen during the last 3 months of pregnancy unless definitely directed to do so by a doctor because it may cause problems in the unborn child or complications during delivery.
Keep out of reach of children. In case of overdose, get medical help or contact a Poison Control Center right away.

Directions

- do not take more than directed
- the smallest effective dose should be used
 - adults and children 12 years and over: take 1 capsule every 4 to 6 hours while symptoms persist
 - if pain or fever does not respond to 1 capsule, 2 capsules may be used
 - do not exceed 6 capsules in 24 hours, unless directed by a doctor
 - children under 12 years: ask a doctor

Other information

- each capsule contains: potassium 20 mg
- read all warnings and directions before use. Keep carton.
- store at 20-25°C (68-77°F) ■ avoid excessive heat above 40°C (104°F)

Inactive ingredients FD&C green no. 3, gelatin, medium-chain triglycerides, pharmaceutical ink, polyethylene glycol, potassium hydroxide, purified water, sorbitol sorbitan solution

Questions or comments? call toll free 1-800-88-ADVIL

PRODUCTION

(NOT COLOR ACCURATE)

Job Information	Color Legend
Date 12-OCT-2016 PASS # 1 Component # PAA080006.FDA01 Drawing # DWG-50023475v02	(b) (4)
Identification	
Pfizer Consumer Healthcare	
Printer & User Notes	
PRINTER TO REPLACE ALL FPO CODES WITH SCANNABLE ART. PRINTER RESPONSIBLE FOR ALL TRAPPING, BLEEDS, COATINGS AND RESOLUTION. PRINTER AND USERS RESPONSIBLE FOR PROPER LICENSING OF ALL FONTS USED IN THIS ARTWORK.	
Vendor Identification	
(b) (4)	

DRUG FACTS TEXT DEFINED	TYPE SIZE
• DRUG FACTS TITLE	9 pt
• DRUG FACTS CONTINUED	8 pt
• HEADINGS	8 pt
• SUBHEADINGS/BODY TEXT	6 pt
• LEADING	6.5 pt
• # OF CHARACTERS PER INCH	<39
• BULLETS	5 pt
• SPACE BEFORE BULLET	2 ems
• BARLINES, HAIRLINES	1.5 pt, .5 pt
• SPACE BETWEEN HAIRLINES AND BOX END	2 spaces

NO VARNISH - GLUE AREA



128 CODE = 080006



128 CODE = 080006

Do Not Use if seal under bottle cap imprinted with "SEALED for YOUR PROTECTION" is broken or missing.

Distributed by: Pfizer, Madison, NJ 07940 USA
© 2016 Pfizer Inc. U.S. Patent 6,387,400
For most recent product information, visit www.Advil.com
LIQUI-GELS® is a trademark or registered trademark of Catalent Pharma Solutions.



PAA080006.FDA01

SPECIFIC RULE LEGEND

- CUT _____
- CREASE - - - - -

PRINTED AREA FOR DATE & LOT
LASER CODING (VARNISHED)

This is a representation of an electronic record that was signed electronically and this page is the manifestation of the electronic signature.

/s/

KAREN M MAHONEY
03/08/2017