

JANSSEN, L.P.
RISPERDAL[®] CONSTA[®]
(RISPERIDONE)
LONG-ACTING INJECTION

Increased Mortality in Elderly Patients with Dementia –Related Psychosis

Elderly patients with dementia-related psychosis treated with atypical antipsychotic drugs are at an increased risk of death compared to placebo. Analyses of seventeen placebo controlled trials (modal duration of 10 weeks) in these patients revealed a risk of death in the drug-treated patients of between 1.6 to 1.7 times that seen in placebo-treated patients. Over the course of a typical 10 week controlled trial, the rate of death in drug-treated patients was about 4.5%, compared to a rate of about 2.6% in the placebo group. Although the causes of death were varied, most of the deaths appeared to be either cardiovascular (e.g., heart failure, sudden death) or infectious (e.g., pneumonia) in nature. RISPERDAL[®] CONSTA[®](risperidone) is not approved for the treatment of patients with Dementia-Related Psychosis.

DESCRIPTION

RISPERDAL[®] (risperidone) is a psychotropic agent belonging to the chemical class of benzisoxazole derivatives. The chemical designation is 3-[2-[4-(6-fluoro-1,2-benzisoxazol-3-yl)-1-piperidinyl]ethyl]-6,7,8,9-tetrahydro-2-methyl-4H-pyrido[1,2-a]pyrimidin-4-one. Its molecular formula is C₂₃H₂₇FN₄O₂ and its molecular weight is 410.49. The structural formula is:

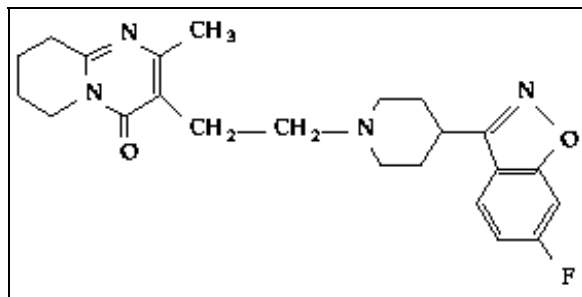

Risperidone is practically insoluble in water, freely soluble in methylene chloride, and soluble in methanol and 0.1 N HCl.

RISPERDAL[®] CONSTA[®] (risperidone) Long-Acting Injection is a combination of extended release microspheres for injection and diluent for parenteral use.

The extended release microspheres formulation is a white to off-white, free-flowing powder that is available in dosage strengths of 12.5, 25, 37.5, or 50 mg risperidone per vial. Risperidone is micro-encapsulated in 7525 polylactide-co-glycolide (PLG) at a concentration of 381 mg risperidone per gram of microspheres.

The diluent for parenteral use is a clear, colorless solution. Composition of the diluent includes polysorbate 20, sodium carboxymethyl cellulose, disodium hydrogen phosphate dihydrate, citric acid anhydrous, sodium chloride, sodium hydroxide, and water for injection. The microspheres are suspended in the diluent prior to injection.

RISPERDAL[®] CONSTA[®] is provided as a dose pack, consisting of a vial containing the microspheres, a pre-filled syringe containing the diluent, a SmartSite[®] Needle-Free Vial Access Device, and one Needle-Pro[®] 20 G TW safety needle.

CLINICAL PHARMACOLOGY

Pharmacodynamics

The mechanism of action of RISPERDAL[®] (risperidone), as with other drugs used to treat schizophrenia, is unknown. However, it has been proposed that the drug's therapeutic activity in schizophrenia is mediated through a combination of dopamine Type 2 (D₂) and serotonin Type 2 (5HT₂) receptor antagonism. Antagonism at receptors other than D₂ and 5HT₂ may explain some of the other effects of RISPERDAL[®].

RISPERDAL[®] is a selective monoaminergic antagonist with high affinity (K_i of 0.12 to 7.3 nM) for the serotonin Type 2 (5HT₂), dopamine Type 2 (D₂), α₁ and α₂ adrenergic, and H₁ histaminergic receptors. RISPERDAL[®] acts as an antagonist at other receptors, but with lower potency. RISPERDAL[®] has low to moderate affinity (K_i of 47 to 253 nM) for the serotonin 5HT_{1C}, 5HT_{1D}, and 5HT_{1A} receptors, weak affinity (K_i of 620 to 800 nM) for the dopamine D₁ and haloperidol-sensitive sigma site, and no affinity (when tested at concentrations >10⁻⁵ M) for cholinergic muscarinic or β₁ and β₂ adrenergic receptors.

Pharmacokinetics

Absorption

After a single intramuscular (gluteal) injection of RISPERDAL[®] CONSTA[®] (risperidone), there is a small initial release of the drug (<about 1% of the dose), followed by a lag time of 3 weeks. The main release of the drug starts from 3 weeks onward, is maintained from 4 to 6 weeks, and subsides by 7 weeks following the intramuscular (IM) injection. Therefore, oral antipsychotic supplementation should be given during the first 3 weeks of treatment with RISPERDAL[®] CONSTA[®] to maintain therapeutic levels until the main release of risperidone from the injection site has begun (see [DOSAGE AND ADMINISTRATION](#)). Following single doses of RISPERDAL[®] CONSTA[®], the pharmacokinetics of risperidone, 9-hydroxyrisperidone (the major metabolite), and risperidone plus 9-hydroxyrisperidone were linear in the dosing range of 12.5 mg to 50 mg.

The combination of the release profile and the dosage regimen (IM injections every 2 weeks) of RISPERDAL® CONSTA® results in sustained therapeutic concentrations. Steady-state plasma concentrations are reached after 4 injections and are maintained for 4 to 6 weeks after the last injection. Following multiple doses of 25 mg to 50 mg RISPERDAL® CONSTA®, plasma concentrations of risperidone, 9-hydroxyrisperidone, and risperidone plus 9-hydroxyrisperidone were linear.

Distribution

Once absorbed, risperidone is rapidly distributed. The volume of distribution is 1-2 L/kg. In plasma, risperidone is bound to albumin and α 1-acid glycoprotein. The plasma protein binding of risperidone is approximately 90%, and that of its major metabolite, 9-hydroxyrisperidone, is 77%. Neither risperidone nor 9-hydroxyrisperidone displaces each other from plasma binding sites. High therapeutic concentrations of sulfamethazine (100 mcg/mL), warfarin (10 mcg/mL), and carbamazepine (10 mcg/mL) caused only a slight increase in the free fraction of risperidone at 10 ng/mL and of 9-hydroxyrisperidone at 50 ng/mL, changes of unknown clinical significance.

Metabolism and Drug Interactions

Risperidone is extensively metabolized in the liver. The main metabolic pathway is through hydroxylation of risperidone to 9-hydroxyrisperidone by the enzyme, CYP 2D6. A minor metabolic pathway is through N-dealkylation. The main metabolite, 9-hydroxyrisperidone, has similar pharmacological activity as risperidone. Consequently, the clinical effect of the drug (i.e., the active moiety) results from the combined concentrations of risperidone plus 9-hydroxyrisperidone.

CYP 2D6, also called debrisoquin hydroxylase, is the enzyme responsible for metabolism of many neuroleptics, antidepressants, antiarrhythmics, and other drugs. CYP 2D6 is subject to genetic polymorphism (about 6%-8% of Caucasians, and a very low percentage of Asians, have little or no activity and are “poor metabolizers”) and to inhibition by a variety of substrates and some non-substrates, notably quinidine. Extensive CYP 2D6 metabolizers convert risperidone rapidly into 9-hydroxyrisperidone, whereas poor CYP 2D6 metabolizers convert it much more slowly. Although extensive metabolizers have lower risperidone and higher 9-hydroxyrisperidone concentrations than poor metabolizers, the pharmacokinetics of the active moiety, after single and multiple doses, are similar in extensive and poor metabolizers.

The interactions of RISPERDAL[®] CONSTA[®] and other drugs have not been systematically evaluated in human subjects. Risperidone could be subject to two kinds of drug-drug interactions (see [PRECAUTIONS - Drug Interactions](#)). First, inhibitors of CYP 2D6 interfere with conversion of risperidone to 9-hydroxyrisperidone. This occurs with quinidine, giving essentially all recipients a risperidone pharmacokinetic profile typical of poor metabolizers. The therapeutic benefits and adverse effects of risperidone in patients receiving quinidine have not been evaluated, but observations in a modest number (n=70) of poor metabolizers given risperidone do not suggest important differences between poor and extensive metabolizers. Second, co-administration of carbamazepine and other known enzyme inducers (e.g., phenytoin, rifampin, and phenobarbital) with risperidone cause a decrease in the combined plasma concentrations of risperidone and 9-hydroxyrisperidone (see [PRECAUTIONS - Drug Interactions](#)). It would also be possible for risperidone to interfere with metabolism of other drugs metabolized by CYP 2D6. Relatively weak binding of risperidone to the enzyme suggests this is unlikely.

In a drug interaction study in schizophrenic patients, 11 subjects received oral risperidone titrated to 6 mg/day for 3 weeks, followed by concurrent administration of carbamazepine for an additional 3 weeks. During co-administration, the plasma concentrations of risperidone and its pharmacologically active metabolite, 9-hydroxyrisperidone, were decreased by about 50%. Plasma concentrations of carbamazepine did not appear to be affected. Co-administration of other known enzyme inducers (e.g., phenytoin, rifampin, and phenobarbital) with risperidone may cause similar decreases in the combined plasma concentrations of risperidone and 9-hydroxyrisperidone, which could lead to decreased efficacy of risperidone treatment (see [PRECAUTIONS – Drug Interactions](#) and [DOSAGE AND ADMINISTRATION – Co-Administration of RISPERDAL[®] CONSTA[®] with Certain Other Medications](#)).

Fluoxetine (20 mg QD) and paroxetine (20 mg QD) have been shown to increase the plasma concentration of risperidone 2.5-2.8 fold and 3-9 fold respectively. Fluoxetine did not affect the plasma concentration of 9-hydroxyrisperidone. Paroxetine lowered the concentration of 9-hydroxyrisperidone by about 10% (see [PRECAUTIONS – Drug Interactions](#) and [DOSAGE AND ADMINISTRATION – Co-Administration of RISPERDAL[®] CONSTA[®] with Certain Other Medications](#)).

Repeated oral doses of risperidone (3 mg BID) did not affect the exposure (AUC) or peak plasma concentrations (C_{max}) of lithium (n=13) (see [PRECAUTIONS – Drug Interactions](#)).

Repeated oral doses of risperidone (4 mg QD) did not affect the pre-dose or average plasma concentrations and exposure (AUC) of valproate (1000 mg/day in three divided doses) compared to placebo (n=21). However, there was a 20% increase in valproate peak plasma concentration (C_{max}) after concomitant administration of risperidone (see [PRECAUTIONS – Drug Interactions](#)).

There were no significant interactions between oral risperidone (1 mg QD) and erythromycin (500 mg QID) (see [PRECAUTIONS – Drug Interactions](#)).

Cimetidine and ranitidine increased the bioavailability of risperidone by 64% and 26%, respectively. However, cimetidine did not affect the AUC of the active moiety, whereas ranitidine increased the AUC of the active moiety by 20%.

Amitriptyline did not affect the pharmacokinetics of risperidone or the active moiety.

In drug interaction studies, risperidone did not significantly affect the pharmacokinetics of donepezil and galantamine, which are metabolized by CYP 2D6.

RISPERDAL[®] (0.25 mg BID) did not show a clinically relevant effect on the pharmacokinetics of digoxin.

Excretion

Risperidone and its metabolites are eliminated via the urine and, to a much lesser extent, via the feces. As illustrated by a mass balance study of a single 1 mg oral dose of ¹⁴C-risperidone administered as solution to three healthy male volunteers, total recovery of radioactivity at 1 week was 84%, including 70% in the urine and 14% in the feces.

The apparent half-life of risperidone plus 9-hydroxyrisperidone following RISPERDAL[®] CONSTA[®] administration is 3 to 6 days, and is associated with a monoexponential decline in plasma concentrations. This half-life of 3-6 days is related to the erosion of the microspheres and subsequent absorption of risperidone. The clearance of risperidone and risperidone plus 9-hydroxyrisperidone was 13.7 L/h and 5.0 L/h in extensive CYP 2D6 metabolizers, and 3.3 L/h and 3.2 L/h in poor CYP 2D6 metabolizers, respectively. No accumulation of risperidone was observed during long-term use (up to 12 months) in patients treated every 2 weeks with 25 mg or 50 mg RISPERDAL[®] CONSTA[®]. The elimination phase is complete approximately 7 to 8 weeks after the last injection.

Special Populations

Renal Impairment

In patients with moderate to severe renal disease treated with oral RISPERDAL®, clearance of the sum of risperidone and its active metabolite decreased by 60% compared with young healthy subjects. Although patients with renal impairment were not studied with RISPERDAL® CONSTA®, it is recommended that patients with renal impairment be carefully titrated on oral RISPERDAL® before treatment with RISPERDAL® CONSTA® is initiated at a dose of 25 mg. A lower initial dose of 12.5 mg may be appropriate when clinical factors warrant dose adjustment, such as in patients with renal impairment (see [PRECAUTIONS – Use in patients with Concomitant Illness](#) and [DOSAGE AND ADMINISTRATION – Dosage in Special Populations](#)).

Hepatic Impairment

While the pharmacokinetics of oral RISPERDAL® in subjects with liver disease were comparable to those in young healthy subjects, the mean free fraction of risperidone in plasma was increased by about 35% because of the diminished concentration of both albumin and α 1-acid glycoprotein. Although patients with hepatic impairment were not studied with RISPERDAL® CONSTA®, it is recommended that patients with hepatic impairment be carefully titrated on oral RISPERDAL® before treatment with RISPERDAL® CONSTA® is initiated at a dose of 25mg. A lower initial dose of 12.5 mg may be appropriate when clinical factors warrant dose adjustment, such as in patients with hepatic impairment (see [PRECAUTIONS – Use in patients with Concomitant Illness](#) and [DOSAGE AND ADMINISTRATION – Dosage in Special Populations](#)).

Elderly

In an open-label trial, steady-state concentrations of risperidone plus 9-hydroxyrisperidone in otherwise healthy elderly patients (≥ 65 years old) treated with RISPERDAL® CONSTA® for up to 12 months fell within the range of values observed in otherwise healthy nonelderly patients. Dosing recommendations are the same for otherwise healthy elderly patients and nonelderly patients (see [DOSAGE AND ADMINISTRATION](#)).

Race and Gender Effects

No specific pharmacokinetic study was conducted to investigate race and gender effects, but a population pharmacokinetic analysis did not identify important differences in the disposition of risperidone due to gender (whether or not corrected for body weight) or race.

CLINICAL TRIALS

The effectiveness of RISPERDAL[®] CONSTA[®] (risperidone) in the treatment of schizophrenia was established, in part, on the basis of extrapolation from the established effectiveness of the oral formulation of risperidone. In addition, the effectiveness of RISPERDAL[®] CONSTA[®] in the treatment of schizophrenia was established in a 12-week, placebo-controlled trial in adult psychotic inpatients and outpatients who met the DSM-IV criteria for schizophrenia.

Efficacy data were obtained from 400 patients with schizophrenia who were randomized to receive injections of 25, 50, or 75 mg RISPERDAL[®] CONSTA[®] or placebo every 2 weeks. During a 1-week run-in period, patients were discontinued from other antipsychotics and were titrated to a dose of 4 mg oral RISPERDAL[®]. Patients who received RISPERDAL[®] CONSTA[®] were given doses of oral RISPERDAL[®] (2 mg for patients in the 25-mg group, 4 mg for patients in the 50-mg group, and 6 mg for patients in the 75-mg group) for the 3 weeks after the first injection to provide therapeutic plasma concentrations until the main release phase of risperidone from the injection site had begun. Patients who received placebo injections were given placebo tablets.

Efficacy was evaluated using the Positive and Negative Syndrome Scale (PANSS), a validated, multi-item inventory, composed of five subscales to evaluate positive symptoms, negative symptoms, disorganized thoughts, uncontrolled hostility/excitement, and anxiety/depression.

The primary efficacy variable in this trial was change from baseline to endpoint in the total PANSS score. The mean total PANSS score at baseline for schizophrenic patients in this study was 81.5.

Total PANSS scores showed significant improvement in the change from baseline to endpoint in schizophrenic patients treated with each dose of RISPERDAL[®] CONSTA[®] (25 mg, 50 mg, or 75 mg) compared with patients treated with placebo. While there were no statistically significant differences between the treatment effects for the three dose groups, the effect size for the 75 mg dose group was actually numerically less than that observed for the 50 mg dose group.

Subgroup analyses did not indicate any differences in treatment outcome as a function of age, race, or gender.

INDICATIONS AND USAGE

RISPERDAL[®] CONSTA[™] (risperidone) is indicated for the treatment of schizophrenia.

The efficacy of RISPERDAL[®] CONSTA[®] is based in part on a 12-week, placebo-controlled trial in schizophrenic inpatients or outpatients, along with extrapolation from the established efficacy of oral RISPERDAL[®] in this population.

The effectiveness of RISPERDAL[®] CONSTA[®] in longer-term use, that is, more than 12 weeks, has not been systematically evaluated in controlled trials. However, oral risperidone has been shown to be effective in delaying time to relapse in longer-term use. Patients should be periodically reassessed to determine the need for continued treatment (see [DOSAGE AND ADMINISTRATION](#)).

CONTRAINDICATIONS

RISPERDAL[®] CONSTA[®] (risperidone) is contraindicated in patients with a known hypersensitivity to the product or any of its components.

WARNINGS

Increased Mortality in Elderly Patients with Dementia-Related Psychosis
Elderly patients with dementia-related psychosis treated with atypical antipsychotic drugs are at an increased risk of death compared to placebo. RISPERDAL[®] CONSTA[®] (risperidone) is not approved for the treatment of dementia-related psychosis (see [Boxed Warning](#)).

Neuroleptic Malignant Syndrome (NMS)

A potentially fatal symptom complex sometimes referred to as Neuroleptic Malignant Syndrome (NMS) has been reported in association with antipsychotic drugs. Clinical manifestations of NMS are hyperpyrexia, muscle rigidity, altered mental status, and evidence of autonomic instability (irregular pulse or blood pressure, tachycardia, diaphoresis, and cardiac dysrhythmia). Additional signs may include elevated creatine phosphokinase, myoglobinuria (rhabdomyolysis), and acute renal failure.

The diagnostic evaluation of patients with this syndrome is complicated. In arriving at a diagnosis, it is important to identify cases in which the clinical presentation includes both serious medical illness (e.g., pneumonia, systemic infection, etc.) and untreated or inadequately treated extrapyramidal signs and symptoms (EPS). Other important considerations in the differential diagnosis include central anticholinergic toxicity, heat stroke, drug fever, and primary central nervous system pathology.

The management of NMS should include: (1) immediate discontinuation of antipsychotic drugs and other drugs not essential to concurrent therapy; (2) intensive symptomatic treatment and medical monitoring; and (3) treatment of any concomitant serious medical problems for which specific treatments are available. There is no

general agreement about specific pharmacological treatment regimens for uncomplicated NMS.

If a patient requires antipsychotic drug treatment after recovery from NMS, the potential reintroduction of drug therapy should be carefully considered. The patient should be carefully monitored, since recurrences of NMS have been reported.

Tardive Dyskinesia

A syndrome of potentially irreversible, involuntary, dyskinetic movements may develop in patients treated with antipsychotic drugs. Although the prevalence of the syndrome appears to be highest among the elderly, especially elderly women, it is impossible to rely upon prevalence estimates to predict, at the inception of antipsychotic treatment, which patients are likely to develop the syndrome. Whether antipsychotic drug products differ in their potential to cause tardive dyskinesia is unknown.

The risk of developing tardive dyskinesia and the likelihood that it will become irreversible are believed to increase as the duration of treatment and the total cumulative dose of antipsychotic drugs administered to the patient increase. However, the syndrome can develop, although much less commonly, after relatively brief treatment periods at low doses.

There is no known treatment for established cases of tardive dyskinesia, although the syndrome may remit, partially or completely, if antipsychotic treatment is withdrawn. Antipsychotic treatment, itself, however, may suppress (or partially suppress) the signs and symptoms of the syndrome and thereby may possibly mask the underlying process. The effect that symptomatic suppression has upon the long-term course of the syndrome is unknown.

Given these considerations, RISPERDAL[®] CONSTA[®] should be prescribed in a manner that is most likely to minimize the occurrence of tardive dyskinesia. Chronic antipsychotic treatment should generally be reserved for patients who suffer from a chronic illness that: (1) is known to respond to antipsychotic drugs, and (2) for whom alternative, equally effective, but potentially less harmful treatments are not available or appropriate. In patients who do require chronic treatment, the smallest dose and the shortest duration of treatment producing a satisfactory clinical response should be sought. The need for continued treatment should be reassessed periodically.

If signs and symptoms of tardive dyskinesia appear in a patient treated with RISPERDAL[®] CONSTA[®], drug discontinuation should be considered. However, some patients may require treatment with RISPERDAL[®] CONSTA[®] despite the presence of the syndrome.

Cerebrovascular Adverse Events, Including Stroke, in Elderly Patients with Dementia-Related Psychosis

Cerebrovascular adverse events (e.g., stroke, transient ischemic attack), including fatalities, were reported in patients (mean age 85 years; range 73-97) in trials of oral risperidone in elderly patients with dementia-related psychosis. In placebo-controlled trials, there was a significantly higher incidence of cerebrovascular adverse events in patients treated with oral risperidone compared to patients treated with placebo. RISPERDAL[®] CONSTA[®] is not approved for the treatment of patients with dementia-related psychosis. (See also [Boxed WARNING, WARNINGS: Increased Mortality in Elderly Patients with Dementia-Related Psychosis.](#))

Hyperglycemia and Diabetes Mellitus

Hyperglycemia, in some cases extreme and associated with ketoacidosis or hyperosmolar coma or death, has been reported in patients treated with atypical antipsychotics including RISPERDAL[®]. Assessment of the relationship between atypical antipsychotic use and glucose abnormalities is complicated by the possibility of an increased background risk of diabetes mellitus in patients with schizophrenia and the increasing incidence of diabetes mellitus in the general population. Given these confounders, the relationship between atypical antipsychotic use and hyperglycemia-related adverse events is not completely understood. However, epidemiological studies suggest an increased risk of treatment-emergent hyperglycemia-related adverse events in patients treated with the atypical antipsychotics. Precise risk estimates for hyperglycemia-related adverse events in patients treated with atypical antipsychotics are not available.

Patients with an established diagnosis of diabetes mellitus who are started on atypical antipsychotics should be monitored regularly for worsening of glucose control. Patients with risk factors for diabetes mellitus (e.g., obesity, family history of diabetes) who are starting treatment with atypical antipsychotics should undergo fasting blood glucose testing at the beginning of treatment and periodically during treatment. Any patient treated with atypical antipsychotics should be monitored for symptoms of hyperglycemia including polydipsia, polyuria, polyphagia, and weakness. Patients who develop symptoms of hyperglycemia during treatment with atypical antipsychotics should undergo fasting blood glucose testing. In some cases, hyperglycemia has resolved when the atypical antipsychotic was discontinued; however, some patients required continuation of anti-diabetic treatment despite discontinuation of the suspect drug.

PRECAUTIONS

General

Administration

RISPERDAL[®] CONSTA[®] should be injected into the gluteal muscle, and care must be taken to avoid inadvertent injection into a blood vessel. (See [DOSAGE AND ADMINISTRATION](#) and [ADVERSE REACTIONS – Postintroduction Reports \[retinal artery occlusion\]](#).)

Orthostatic Hypotension

RISPERDAL[®] CONSTA[®] (risperidone) may induce orthostatic hypotension associated with dizziness, tachycardia, and in some patients, syncope, probably reflecting its alpha-adrenergic antagonistic properties. Syncope was reported in 0.8% (12/1499 patients) of patients treated with RISPERDAL[®] CONSTA[®] in multiple-dose studies. Patients should be instructed in nonpharmacologic interventions that help to reduce the occurrence of orthostatic hypotension (e.g., sitting on the edge of the bed for several minutes before attempting to stand in the morning and slowly rising from a seated position).

RISPERDAL[®] CONSTA[®] should be used with particular caution in (1) patients with known cardiovascular disease (history of myocardial infarction or ischemia, heart failure, or conduction abnormalities), cerebrovascular disease, and conditions which would predispose patients to hypotension, e.g., dehydration and hypovolemia, and (2) in the elderly and patients with renal or hepatic impairment. Monitoring of orthostatic vital signs should be considered in all such patients, and a dose reduction should be considered if hypotension occurs. Clinically significant hypotension has been observed with concomitant use of oral RISPERDAL[®] and antihypertensive medication.

Seizures

During premarketing testing, seizures occurred in 0.3% (5/1499 patients) of patients treated with RISPERDAL[®] CONSTA[®]. Therefore, RISPERDAL[®] CONSTA[®] should be used cautiously in patients with a history of seizures.

Dysphagia

Esophageal dysmotility and aspiration have been associated with antipsychotic drug use. Aspiration pneumonia is a common cause of morbidity and mortality in patients with advanced Alzheimer's dementia. RISPERDAL[®] CONSTA[®] and other antipsychotic drugs should be used cautiously in patients at risk for aspiration pneumonia. (See also [Boxed WARNING, WARNINGS: Increased Mortality in Elderly Patients with Dementia-Related Psychosis](#).)

Osteodystrophy and Tumors in Animals

RISPERDAL[®] CONSTA[®] produced osteodystrophy in male and female rats in a 1-year toxicity study and a 2-year carcinogenicity study at a dose of 40 mg/kg administered IM every 2 weeks.

RISPERDAL[®] CONSTA[®] produced renal tubular tumors (adenoma, adenocarcinoma) and adrenomedullary pheochromocytomas in male rats in the 2-year carcinogenicity study at 40 mg/kg administered IM every 2 weeks. In addition, RISPERDAL[®] CONSTA[®] produced an increase in a marker of cellular proliferation in renal tissue in males in the 1-year toxicity study and in renal tumor-bearing males in the 2-year carcinogenicity study at 40 mg/kg administered IM every 2 weeks. (Cellular proliferation was not measured at the low dose or in females in either study.)

The effect dose for osteodystrophy and the tumor findings is 8 times the IM maximum recommended human dose (MRHD) (50 mg) on a mg/m² basis and is associated with a plasma exposure (AUC) 2 times the expected plasma exposure (AUC) at the IM MRHD. The no-effect dose for these findings was 5 mg/kg (equal to the IM MRHD on a mg/m² basis). Plasma exposure (AUC) at the no-effect dose was one third the expected plasma exposure (AUC) at the IM MRHD.

Neither the renal or adrenal tumors, nor osteodystrophy, were seen in studies of orally administered risperidone. Osteodystrophy was not observed in dogs at doses up to 14 times (based on AUC) the IM MRHD in a 1-year toxicity study.

The renal tubular and adrenomedullary tumors in male rats and other tumor findings are described in more detail under PRECAUTIONS, Carcinogenicity, Mutagenesis, Impairment of Fertility.

The relevance of these findings to human risk is unknown.

Hyperprolactinemia

As with other drugs that antagonize dopamine D₂ receptors, risperidone elevates prolactin levels and the elevation persists during chronic administration. Risperidone is associated with higher levels of prolactin elevation than other antipsychotic agents.

Hyperprolactinemia may suppress hypothalamic GnRH, resulting in reduced pituitary gonadotropin secretion. This, in turn, may inhibit reproductive function by impairing gonadal steroidogenesis in both female and male patients. Galactorrhea, amenorrhea, gynecomastia, and impotence have been reported in patients receiving prolactin-elevating compounds. Long-standing hyperprolactinemia when associated with hypogonadism may lead to decreased bone density in both female and male subjects.

Tissue culture experiments indicate that approximately one-third of human breast cancers are prolactin dependent *in vitro*, a factor of potential importance if the prescription of these drugs is contemplated in a patient with previously detected breast cancer. An increase in pituitary gland, mammary gland, and pancreatic islet cell neoplasia (mammary adenocarcinomas, pituitary and pancreatic adenomas) was observed in the risperidone carcinogenicity studies conducted in mice and rats (see [PRECAUTIONS – Carcinogenesis, Mutagenesis, Impairment of Fertility](#)). Neither clinical studies nor epidemiologic studies conducted to date have shown an association between chronic administration of this class of drugs and tumorigenesis in humans; the available evidence is considered too limited to be conclusive at this time.

Potential for Cognitive and Motor Impairment

Somnolence was reported by 5% of patients treated with RISPERDAL[®] CONSTA[®] in multiple-dose trials. Since risperidone has the potential to impair judgment, thinking, or motor skills, patients should be cautioned about operating hazardous machinery, including automobiles, until they are reasonably certain that treatment with RISPERDAL[®] CONSTA[®] does not affect them adversely.

Priapism

No cases of priapism have been reported in patients treated with RISPERDAL[®] CONSTA[®]. However, rare cases of priapism have been reported in patients treated with oral RISPERDAL[®]. While the relationship of these events to oral RISPERDAL[®] use has not been established, other drugs with alpha-adrenergic blocking effects have been reported to induce priapism, and it is possible that RISPERDAL[®] may share this capacity. Severe priapism may require surgical intervention.

Thrombotic Thrombocytopenic Purpura (TTP)

A single case of TTP was reported in a 28 year-old female patient receiving oral RISPERDAL[®] in a large, open premarketing experience (approximately 1300 patients). She experienced jaundice, fever, and bruising, but eventually recovered after receiving plasmapheresis. The relationship to RISPERDAL[®] therapy is unknown.

Antiemetic Effect

Risperidone has an antiemetic effect in animals; this effect may also occur in humans, and may mask signs and symptoms of overdose with certain drugs or of conditions such as intestinal obstruction, Reye's syndrome, and brain tumor.

Body Temperature Regulation

Disruption of body temperature regulation has been attributed to antipsychotic agents. Both hyperthermia and hypothermia have been reported in association with oral

RISPERDAL[®] use. Caution is advised when prescribing RISPERDAL[®] CONSTA[®] for patients who will be exposed to temperature extremes.

Suicide

The possibility of a suicide attempt is inherent in schizophrenia, and close supervision of high-risk patients should accompany drug therapy. RISPERDAL[®] CONSTA[®] is to be administered by a health care professional (see [DOSAGE and ADMINISTRATION](#)); therefore, suicide due to an overdose is unlikely.

Use in Patients with Concomitant Illness

Clinical experience with RISPERDAL[®] CONSTA[®] in patients with certain concomitant systemic illnesses is limited. Patients with Parkinson's Disease or Dementia with Lewy Bodies who receive antipsychotics, including RISPERDAL[®] CONSTA[®], are reported to have an increased sensitivity to antipsychotic medications. Manifestations of this increased sensitivity have been reported to include confusion, obtundation, postural instability with frequent falls, extrapyramidal symptoms, and clinical features consistent with the neuroleptic malignant syndrome.

Caution is advisable when using RISPERDAL[®] CONSTA[®] in patients with diseases or conditions that could affect metabolism or hemodynamic responses. RISPERDAL[®] CONSTA[®] has not been evaluated or used to any appreciable extent in patients with a recent history of myocardial infarction or unstable heart disease. Patients with these diagnoses were excluded from clinical studies during the product's premarket testing.

Increased plasma concentrations of risperidone and 9-hydroxyrisperidone occur in patients with severe renal impairment (creatinine clearance <30 mL/min/1.73 m²) treated with oral RISPERDAL[®]; an increase in the free fraction of risperidone is also seen in patients with severe hepatic impairment. Patients with renal or hepatic impairment should be carefully titrated on oral RISPERDAL[®] before treatment with RISPERDAL[®] CONSTA[®] is initiated at a dose of 25 mg. A lower initial dose of 12.5 mg may be appropriate when clinical factors warrant dose adjustment, such as in patients with renal or hepatic impairment (see [DOSAGE AND ADMINISTRATION – Dosage in Special Populations](#)).

Information for Patients

Physicians are advised to discuss the following issues with patients for whom they prescribe RISPERDAL[®] CONSTA[®].

Orthostatic Hypotension

Patients should be advised of the risk of orthostatic hypotension and instructed in nonpharmacologic interventions that help to reduce the occurrence of orthostatic

hypotension (e.g., sitting on the edge of the bed for several minutes before attempting to stand in the morning and slowly rising from a seated position).

Interference With Cognitive and Motor Performance

Because RISPERDAL[®] CONSTA[®] has the potential to impair judgment, thinking, or motor skills, patients should be cautioned about operating hazardous machinery, including automobiles, until they are reasonably certain that treatment with RISPERDAL[®] CONSTA[®] does not affect them adversely.

Pregnancy

Patients should be advised to notify their physician if they become pregnant or intend to become pregnant during therapy and for at least 12 weeks after the last injection of RISPERDAL[®] CONSTA[®].

Nursing

Patients should be advised not to breast-feed an infant during treatment and for at least 12 weeks after the last injection of RISPERDAL[®] CONSTA[®].

Concomitant Medication

Patients should be advised to inform their physicians if they are taking, or plan to take, any prescription or over-the-counter drugs, since there is a potential for interactions.

Alcohol

Patients should be advised to avoid alcohol during treatment with RISPERDAL[®] CONSTA[®].

Laboratory Tests

No specific laboratory tests are recommended.

Drug Interactions

The interactions of RISPERDAL[®] CONSTA[®] and other drugs have not been systematically evaluated. Given the primary CNS effects of risperidone, caution should be used when RISPERDAL[®] CONSTA[®] is administered in combination with other centrally-acting drugs or alcohol.

Because of its potential for inducing hypotension, RISPERDAL[®] CONSTA[®] may enhance the hypotensive effects of other therapeutic agents with this potential.

RISPERDAL[®] CONSTA[®] may antagonize the effects of levodopa and dopamine agonists.

Amitriptyline did not affect the pharmacokinetics of risperidone or the active moiety. Cimetidine and ranitidine increased the bioavailability of risperidone by 64% and

26%, respectively. However, cimetidine did not affect the AUC of the active moiety, whereas ranitidine increased the AUC of the active moiety by 20%.

Chronic administration of clozapine with risperidone may decrease the clearance of risperidone.

Carbamazepine and Other CYP 3A4 Enzyme Inducers

In a drug interaction study in schizophrenic patients, 11 subjects received oral risperidone titrated to 6 mg/day for 3 weeks, followed by concurrent administration of carbamazepine for an additional 3 weeks. During co-administration, the plasma concentrations of risperidone and its pharmacologically active metabolite, 9-hydroxyrisperidone, were decreased by about 50%. Plasma concentrations of carbamazepine did not appear to be affected. Co-administration of other known CYP 3A4 enzyme inducers (e.g., phenytoin, rifampin, and phenobarbital) with risperidone may cause similar decreases in the combined plasma concentrations of risperidone and 9-hydroxyrisperidone, which could lead to decreased efficacy of RISPERDAL® CONSTA® treatment. At the initiation of therapy with carbamazepine or other known CYP 3A4 hepatic enzyme inducers, patients should be closely monitored during the first 4-8 weeks, since the dose of RISPERDAL® CONSTA® may need to be adjusted. A dose increase, or additional oral RISPERDAL®, may need to be considered. On discontinuation of carbamazepine or other CYP 3A4 hepatic enzyme inducers, the dosage of RISPERDAL® CONSTA® should be re-evaluated and, if necessary, decreased. Patients may be placed on a lower dose of RISPERDAL® CONSTA® between 2 to 4 weeks before the planned discontinuation of carbamazepine or other CYP 3A4 enzyme inducers to adjust for the expected increase in plasma concentrations of risperidone plus 9-hydroxyrisperidone. For patients treated with the recommended dose of 25 mg RISPERDAL® CONSTA® and discontinuing from carbamazepine or other CYP 3A4 enzyme inducers, it is recommended to continue treatment with the 25-mg dose unless clinical judgment necessitates lowering the RISPERDAL® CONSTA® dose to 12.5 mg or necessitates interruption of RISPERDAL® CONSTA® treatment. (See also [DOSAGE AND ADMINISTRATION](#).) The efficacy of the 12.5 mg dose has not been investigated in clinical trials.

Fluoxetine and Paroxetine

Fluoxetine (20 mg QD) and paroxetine (20 mg QD), CYP 2D6 inhibitors, have been shown to increase the plasma concentration of risperidone 2.5-2.8 fold and 3-9 fold, respectively. Fluoxetine did not affect the plasma concentration of 9-hydroxyrisperidone. Paroxetine lowered the concentration of 9-hydroxyrisperidone by about 10%. When either concomitant fluoxetine or paroxetine is initiated or

discontinued, the physician should re-evaluate the dose of RISPERDAL[®] CONSTA[®]. When initiation of fluoxetine or paroxetine is considered, patients may be placed on a lower dose of RISPERDAL[®] CONSTA[®] between 2 to 4 weeks before the planned start of fluoxetine or paroxetine therapy to adjust for the expected increase in plasma concentrations of risperidone. When fluoxetine or paroxetine is initiated in patients receiving the recommended dose of 25 mg RISPERDAL[®] CONSTA[®], it is recommended to continue treatment with the 25-mg dose unless clinical judgment necessitates lowering the RISPERDAL[®] CONSTA[®] dose to 12.5 mg or necessitates interruption of RISPERDAL[®] CONSTA[®] treatment. When RISPERDAL[®] CONSTA[®] is initiated in patients already receiving fluoxetine or paroxetine, a starting dose of 12.5 mg can be considered. The efficacy of the 12.5 mg dose has not been investigated in clinical trials. (See also [DOSAGE AND ADMINISTRATION](#).) The effects of discontinuation of concomitant fluoxetine or paroxetine therapy on the pharmacokinetics of risperidone and 9-hydroxyrisperidone have not been studied.

Lithium

Repeated oral doses of risperidone (3 mg BID) did not affect the exposure (AUC) or peak plasma concentrations (C_{max}) of lithium (n=13).

Valproate

Repeated oral doses of risperidone (4 mg QD) did not affect the pre-dose or average plasma concentrations and exposure (AUC) of valproate (1000 mg/day in three divided doses) compared to placebo (n=21). However, there was a 20% increase in valproate peak plasma concentration (C_{max}) after concomitant administration of risperidone.

Digoxin

RISPERDAL[®] (0.25 mg BID) did not show a clinically relevant effect on the pharmacokinetics of digoxin.

Drugs that Inhibit CYP 2D6 and Other CYP Isozymes

Risperidone is metabolized to 9-hydroxyrisperidone by CYP 2D6, an enzyme that is polymorphic in the population and that can be inhibited by a variety of psychotropic and other drugs (see [CLINICAL PHARMACOLOGY](#)). Drug interactions that reduce the metabolism of risperidone to 9-hydroxyrisperidone would increase the plasma concentrations of risperidone and lower the concentrations of 9-hydroxyrisperidone. Analysis of clinical studies involving a modest number of poor metabolizers (n \approx 70 patients) does not suggest that poor and extensive metabolizers have different rates of adverse effects. No comparison of effectiveness in the two groups has been made.

In vitro studies showed that drugs metabolized by other CYP isozymes, including 1A1, 1A2, 2C9, 2C19, and 3A4, are only weak inhibitors of risperidone metabolism.

There were no significant interactions between risperidone and erythromycin (see [CLINICAL PHARMACOLOGY](#)).

Drugs Metabolized by CYP 2D6

In vitro studies indicate that risperidone is a relatively weak inhibitor of CYP 2D6. Therefore, RISPERDAL[®] CONSTA[®] is not expected to substantially inhibit the clearance of drugs that are metabolized by this enzymatic pathway. In drug interaction studies, oral risperidone did not significantly affect the pharmacokinetics of donepezil and galantamine, which are metabolized by CYP 2D6.

Carcinogenesis, Mutagenesis, Impairment of Fertility

Carcinogenesis - Oral

Carcinogenicity studies were conducted in Swiss albino mice and Wistar rats. Risperidone was administered in the diet at doses of 0.63, 2.5, and 10 mg/kg for 18 months to mice and for 25 months to rats. These doses are equivalent to 2.4, 9.4, and 37.5 times the oral maximum recommended human dose (MRHD) for schizophrenia (16 mg/day) on a mg/kg basis, or 0.2, 0.75, and 3 times the oral MRHD (mice) or 0.4, 1.5, and 6 times the oral MRHD (rats) on a mg/m² basis. A maximum tolerated dose was not achieved in male mice. There was a significant increase in pituitary gland adenomas in female mice at doses 0.75 and 3 times the oral MRHD on a mg/m² basis. There was a significant increase in endocrine pancreatic adenomas in male rats at doses 1.5 and 6 times the oral MRHD on a mg/m² basis. Mammary gland adenocarcinomas were significantly increased in female mice at all doses tested (0.2, 0.75, and 3 times the oral MRHD on a mg/m² basis), in female rats at all doses tested (0.4, 1.5, and 6 times the oral MRHD on a mg/m² basis), and in male rats at a dose 6 times the oral MRHD on a mg/m² basis.

Carcinogenesis - IM

RISPERDAL[®] CONSTA[®] was evaluated in a 24-month carcinogenicity study in which SPF Wistar rats were treated every 2 weeks with IM injections of either 5 mg/kg or 40 mg/kg of risperidone. These doses are 1 and 8 times the MRHD (50 mg) on a mg/m² basis. A control group received injections of 0.9% NaCl, and a vehicle control group was injected with placebo microspheres. There was a significant increase in pituitary gland adenomas, endocrine pancreas adenomas, and adrenomedullary pheochromocytomas at 8 times the IM MRHD on a mg/m² basis. The incidence of mammary gland adenocarcinomas was significantly increased in female rats at both doses (1 and 8 times the IM MRHD on a mg/m² basis). A significant increase in renal tubular tumors (adenoma, adenocarcinomas) was observed in male

rats at 8 times the IM MRHD on a mg/m² basis. Plasma exposures (AUC) in rats were 0.3 and 2 times (at 5 and 40 mg/kg, respectively) the expected plasma exposure (AUC) at the IM MRHD.

Dopamine D₂ receptor antagonists have been shown to chronically elevate prolactin levels in rodents. Serum prolactin levels were not measured during the carcinogenicity studies of oral risperidone; however, measurements taken during subchronic toxicity studies showed that oral risperidone elevated serum prolactin levels 5- to 6-fold in mice and rats at the same doses used in the oral carcinogenicity studies. Serum prolactin levels increased in a dose-dependent manner up to 6- and 1.5-fold in male and female rats, respectively, at the end of the 24-month treatment with RISPERDAL[®] CONSTA[®] every 2 weeks. Increases in the incidence of pituitary gland, endocrine pancreas, and mammary gland neoplasms have been found in rodents after chronic administration of other antipsychotic drugs and may be prolactin-mediated.

The relevance for human risk of the findings of prolactin-mediated endocrine tumors in rodents is unknown (see [PRECAUTIONS - Hyperprolactinemia](#)).

Mutagenesis

No evidence of mutagenic potential for oral risperidone was found in the *in vitro* Ames reverse mutation test, *in vitro* mouse lymphoma assay, *in vitro* rat hepatocyte DNA-repair assay, *in vivo* oral micronucleus test in mice, the sex-linked recessive lethal test in *Drosophila*, or the *in vitro* chromosomal aberration test in human lymphocytes or in Chinese hamster cells.

In addition, no evidence of mutagenic potential was found in the *in vitro* Ames reverse mutation test for RISPERDAL[®] CONSTA[®].

Impairment of Fertility

Oral risperidone (0.16 to 5 mg/kg) was shown to impair mating, but not fertility, in Wistar rats in three reproductive studies (two mating and fertility studies and a multigenerational study) at doses 0.1 to 3 times the oral maximum recommended human dose (MRHD) (16 mg/day) on a mg/m² basis. The effect appeared to be in females, since impaired mating behavior was not noted in the mating and fertility study in which males only were treated. In a subchronic study in Beagle dogs in which oral risperidone was administered at doses of 0.31 to 5 mg/kg, sperm motility and concentration were decreased at doses 0.6 to 10 times the oral MRHD on a mg/m² basis. Dose-related decreases were also noted in serum testosterone at the same doses. Serum testosterone and sperm values partially recovered, but remained decreased after treatment was discontinued. No no-effect doses were noted in either rat or dog.

No mating and fertility studies were conducted with RISPERDAL[®] CONSTA[®].

Pregnancy

Pregnancy Category C

The teratogenic potential of oral risperidone was studied in three embryofetal development studies in Sprague-Dawley and Wistar rats (0.63-10 mg/kg or 0.4 to 6 times the oral maximum recommended human dose [MRHD] on a mg/m² basis) and in one embryofetal development study in New Zealand rabbits (0.31-5 mg/kg or 0.4 to 6 times the oral MRHD on a mg/m² basis). The incidence of malformations was not increased compared to control in offspring of rats or rabbits given 0.4 to 6 times the oral MRHD on a mg/m² basis. In three reproductive studies in rats (two peri/post-natal development studies and a multigenerational study), there was an increase in pup deaths during the first 4 days of lactation at doses of 0.16-5 mg/kg or 0.1 to 3 times the oral MRHD on a mg/m² basis. It is not known whether these deaths were due to a direct effect on the fetuses or pups or to effects on the dams.

There was no no-effect dose for increased rat pup mortality. In one peri/post-natal development study, there was an increase in stillborn rat pups at a dose of 2.5 mg/kg or 1.5 times the oral MRHD on a mg/m² basis. In a cross-fostering study in Wistar rats, toxic effects on the fetus or pups, as evidenced by a decrease in the number of live pups and an increase in the number of dead pups at birth (Day 0), and a decrease in birth weight in pups of drug-treated dams were observed. In addition, there was an increase in deaths by Day 1 among pups of drug-treated dams, regardless of whether or not the pups were cross-fostered. Risperidone also appeared to impair maternal behavior in that pup body weight gain and survival (from Days 1 to 4 of lactation) were reduced in pups born to control but reared by drug-treated dams. These effects were all noted at the one dose of risperidone tested, i.e., 5 mg/kg or 3 times the oral MRHD on a mg/m² basis.

No studies were conducted with RISPERDAL[®] CONSTA[®].

Placental transfer of risperidone occurs in rat pups. There are no adequate and well-controlled studies in pregnant women. However, there was one report of a case of agenesis of the corpus callosum in an infant exposed to risperidone *in utero*. The causal relationship to oral RISPERDAL[®] therapy is unknown. Reversible extrapyramidal symptoms in the neonate were observed following postmarketing use of risperidone during the last trimester of pregnancy.

RISPERDAL[®] CONSTA[®] should be used during pregnancy only if the potential benefit justifies the potential risk to the fetus.

Labor and Delivery

The effect of RISPERDAL[®] CONSTA[®] on labor and delivery in humans is unknown.

Nursing Mothers

In animal studies, risperidone and 9-hydroxyrisperidone are excreted in milk. Risperidone and 9-hydroxyrisperidone are also excreted in human breast milk. Therefore, women should not breast-feed during treatment with RISPERDAL[®] CONSTA[®] and for at least 12 weeks after the last injection.

Pediatric Use

RISPERDAL[®] CONSTA[®] has not been studied in children younger than 18 years old.

Geriatric Use

In an open-label study, 57 clinically stable, elderly patients (≥65 years old) with schizophrenia or schizoaffective disorder received RISPERDAL[®] CONSTA[®] every 2 weeks for up to 12 months. In general, no differences in the tolerability of RISPERDAL[®] CONSTA[®] were observed between otherwise healthy elderly and nonelderly patients. Therefore, dosing recommendations for otherwise healthy elderly patients are the same as for nonelderly patients. Because elderly patients exhibit a greater tendency to orthostatic hypotension than nonelderly patients, elderly patients should be instructed in nonpharmacologic interventions that help to reduce the occurrence of orthostatic hypotension (e.g., sitting on the edge of the bed for several minutes before attempting to stand in the morning and slowly rising from a seated position). In addition, monitoring of orthostatic vital signs should be considered in elderly patients for whom orthostatic hypotension is of concern (see [CLINICAL PHARMACOLOGY](#), [PRECAUTIONS](#), and [DOSAGE AND ADMINISTRATION](#)).

Concomitant use with Furosemide in Elderly Patients with Dementia-Related Psychosis

In two of four placebo-controlled trials in elderly patients with dementia-related psychosis, a higher incidence of mortality was observed in patients treated with furosemide plus oral risperidone when compared to patients treated with oral risperidone alone or with oral placebo plus furosemide. No pathological mechanism has been identified to explain this finding, and no consistent pattern for cause of death was observed. An increase of mortality in elderly patients with dementia-related psychosis was seen with the use of oral risperidone regardless of concomitant use with furosemide. RISPERDAL[®] CONSTA[®] is not approved for the treatment of patients with dementia-related psychosis. (See [Boxed WARNING](#), [WARNINGS: Increased Mortality in Elderly Patients with Dementia-Related Psychosis](#).)

ADVERSE REACTIONS

Adverse findings were assessed by spontaneous reports of adverse events, laboratory tests, vital signs, body weight, and ECGs. Adverse events were classified using the World Health Organization preferred terms. Treatment-emergent adverse events were defined as those events with an onset between the first dose and 49 days after the last dose.

The prescriber should be aware that these figures cannot be used to predict the incidence of side effects in the course of usual medical practice where patient characteristics and other factors differ from those which prevailed in this clinical trial. Similarly, the cited frequencies cannot be compared with figures obtained from other clinical investigations involving different treatments, uses, and investigators. The cited figures, however, do provide the prescribing physician with some basis for estimating the relative contribution of drug and nondrug factors to the side effect incidence rate in the population studied.

Associated with Discontinuation of Treatment

In the 12-week, placebo-controlled trial, the incidence of schizophrenic patients who discontinued treatment due to an adverse event was lower with RISPERDAL[®] CONSTA[®] (11%; 22/202 patients) than with placebo (13%; 13/98 patients).

Incidence in Controlled Trials

The incidence of adverse reactions in the placebo-controlled trial was based on 202 schizophrenic patients treated with 25 or 50 mg RISPERDAL[®] CONSTA[®] and 98 schizophrenic patients treated with placebo for up to 12 weeks.

Commonly Observed Adverse Events in Controlled Clinical Trials

Spontaneously reported, treatment-emergent adverse events with an incidence of 5% or greater in at least one of the RISPERDAL[®] CONSTA[®] groups (25 mg or 50 mg) and at least twice that of placebo were: somnolence, akathisia, parkinsonism, dyspepsia, constipation, dry mouth, fatigue, weight increase.

Adverse Events Occurring at an Incidence of 2% or More in Patients Treated with RISPERDAL[®] CONSTA[®]:

[Table 1](#) enumerates adverse events that occurred at an incidence of 2% or more, and were at least as frequent among patients treated with 25 mg or 50 mg RISPERDAL[®] CONSTA[™] as patients treated with placebo in the 12-week, placebo-controlled trial. This table shows the percentage of patients in each dose group who spontaneously reported at least one episode of an event at some time during double-blind treatment. All patients were titrated to a dose of 4 mg oral RISPERDAL[®] during a 1-week run-in period. Patients who received RISPERDAL[®] CONSTA[®] were given doses of oral

RISPERDAL[®] (2 mg for patients in the 25-mg group, and 4 mg for patients in the 50-mg group) during the 3 weeks after the first injection to provide therapeutic levels until the main release phase of risperidone from the injection site had begun. Patients who received placebo injections were given placebo tablets.

Table 1. Incidence (% of Patients) of Treatment-Emergent Adverse Events in a 12-Week, Placebo-Controlled Clinical Trial

WHO Body System Disorder/ Preferred Term	RISPERDAL® CONSTA®		Placebo (N=98)
	25 mg (N=99)	50 mg (N=103)	
Psychiatric			
Insomnia	16	13	14
Hallucination	7	6	5
Somnolence	5	6	3
Suicide attempt	1	4	3
Abnormal thinking	0	3	2
Abnormal dreaming	2	0	0
Central & peripheral nervous system			
Headache	15	22	12
Dizziness	8	11	6
Akathisia	2	9	4
Parkinsonism ^a	4	10	3
Tremor	0	3	0
Hypoaesthesia	2	0	0
Gastrointestinal			
Dyspepsia	7	7	2
Constipation	5	7	1
Mouth dry	0	7	1
Toothache	1	3	0
Saliva increased	6	2	1
Tooth disorder	4	2	0
Diarrhea	5	1	3
Body as a whole - general			
Fatigue	3	7	0
Pain	10	3	4
Peripheral edema	2	3	1
Leg pain	4	1	1
Fever	2	1	0
Syncope	2	0	0
Respiratory system			
Rhinitis	14	4	8
Coughing	5	2	4
Sinusitis	3	1	0
Upper respiratory tract infection	2	0	1
Metabolic & nutritional			
Weight increase	5	4	2
Weight decrease	4	1	1
Cardiovascular			
Hypertension	3	3	2
Hearing & vestibular			
Ear disorder (NOS)	0	3	0
Vision			
Vision abnormal	2	3	0
Skin & appendages			
Acne	2	2	0
Skin dry	2	0	0
Musculo-Skeletal			
Myalgia	4	2	1

^a Includes adverse events of bradykinesia, extrapyramidal disorder, and hypokinesia.

Dose Dependency of Adverse Events

Extrapyramidal Symptoms:

Two methods were used to measure extrapyramidal symptoms (EPS) in the 12-week, placebo-controlled trial comparing three doses of RISPERDAL[®] CONSTA[®] (25 mg, 50 mg, and 75 mg) with placebo, including: (1) the incidence of spontaneous reports of EPS symptoms; and (2) the change from baseline to endpoint on the total score (sum of the subscale scores for parkinsonism, dystonia, and dyskinesia) of the Extrapyramidal Symptom Rating Scale (ESRS).

As shown in [Table 1](#), the overall incidence of EPS-related adverse events (akathisia, dystonia, parkinsonism, and tremor) in patients treated with 25 mg RISPERDAL[®] CONSTA[®] was comparable to that of patients treated with placebo; the incidence of EPS-related adverse events was higher in patients treated with 50 mg RISPERDAL[®] CONSTA[®].

The median change from baseline to endpoint in total ESRS score showed no worsening in patients treated with RISPERDAL[®] CONSTA[®] compared with patients treated with placebo: 0 (placebo group); -1 (25-mg group, significantly less than the placebo group); and 0 (50-mg group).

Vital Sign Changes:

RISPERDAL[®] is associated with orthostatic hypotension and tachycardia (see [PRECAUTIONS](#)). In the placebo-controlled trial, orthostatic hypotension was observed in 2% of patients treated with 25 mg or 50 mg RISPERDAL[®] CONSTA[®] (see [PRECAUTIONS](#)).

Weight Changes:

In the 12-week, placebo-controlled trial, 9% of patients treated with RISPERDAL[®] CONSTA[®], compared with 6% of patients treated with placebo, experienced a weight gain of >7% of body weight at endpoint.

Laboratory Changes:

The percentage of patients treated with RISPERDAL[®] CONSTA[®] who experienced potentially important changes in routine serum chemistry, hematology, or urinalysis parameters was similar to or less than that of placebo patients. Additionally, no patients discontinued treatment due to changes in serum chemistry, hematology, or urinalysis parameters.

ECG Changes:

The electrocardiograms of 202 schizophrenic patients treated with 25 mg or 50 mg RISPERDAL[®] CONSTA[®] and 98 schizophrenic patients treated with placebo in a

12-week, double-blind, placebo-controlled trial were evaluated. Compared with placebo, there were no statistically significant differences in QTc intervals (using Fridericia's and linear correction factors) during treatment with RISPERDAL[®] CONSTA[®].

Between-group comparisons for pooled placebo-controlled trials with oral RISPERDAL[®] revealed no statistically significant differences between risperidone and placebo in mean changes from baseline in ECG parameters, including QT, QTc, and PR intervals, and heart rate. When all oral RISPERDAL[®] doses were pooled from randomized controlled trials in several indications, there was a mean increase in heart rate of 1 beat per minute compared to no change for placebo patients. In short-term schizophrenia trials, higher doses of oral risperidone (8-16 mg/day) were associated with a higher mean increase in heart rate compared to placebo (4-6 beats per minute).

Pain Assessment and Local Injection Site Reactions:

The mean intensity of injection pain reported by patients using a visual analog scale (0 = no pain to 100 = unbearably painful) decreased in all treatment groups from the first to the last injection (placebo: 16.7 to 12.6; 25 mg: 12.0 to 9.0; 50 mg: 18.2 to 11.8). After the sixth injection (Week 10), investigator ratings indicated that 1% of patients treated with 25 mg or 50 mg RISPERDAL[®] CONSTA[®] experienced redness, swelling, or induration at the injection site.

Other Events Observed During the Premarketing Evaluation of RISPERDAL[®] CONSTA[®]

During its premarketing assessment, RISPERDAL[®] CONSTA[®] was administered to 1499 patients in multiple-dose studies. The conditions and duration of exposure to RISPERDAL[®] CONSTA[®] varied greatly, and included (in overlapping categories) open-label and double-blind studies, uncontrolled and controlled studies, inpatient and outpatient studies, fixed-dose and titration studies, and short-term and long-term exposure studies. In all studies, untoward events associated with this exposure were obtained by spontaneous report and were recorded by clinical investigators using terminology of their own choosing. Consequently, it is not possible to provide a meaningful estimate of the proportion of individuals experiencing adverse events without first grouping similar types of untoward events into a smaller number of standardized event categories.

In the listings that follow, spontaneously reported adverse events were classified using World Health Organization (WHO) preferred terms. The frequencies presented, therefore, represent the proportion of the 1499 patients exposed to multiple doses of RISPERDAL[®] CONSTA[®] who experienced an event of the type cited on at least one occasion while receiving RISPERDAL[®] CONSTA[®]. All reported events are included

except those already listed in [Table 1](#), those events for which a drug cause was remote, those event terms which were so general as to be uninformative, and those events reported only once which did not have a substantial probability of being acutely life-threatening. It is important to emphasize that, although the reported events occurred during treatment with RISPERDAL[®] CONSTA[®], they were not necessarily caused by it.

Events are further categorized by body system and listed in order of decreasing frequency according to the following definitions: frequent adverse events are those occurring in at least 1/100 patients (only those not already listed in the tabulated results from the placebo-controlled trial appear in this listing); infrequent adverse events are those occurring in 1/100 to 1/1000 patients; and rare events are those occurring in fewer than 1/1000 patients.

Psychiatric Disorders

Frequent: anxiety, psychosis, depression, agitation, nervousness, paranoid reaction, delusion, apathy. *Infrequent:* anorexia, impaired concentration, impotence, emotional lability, manic reaction, decreased libido, increased appetite, amnesia, confusion, euphoria, depersonalization, paroniria, delirium, psychotic depression.

Central and Peripheral Nervous System Disorders

Frequent: hypertonia, dystonia. *Infrequent:* dyskinesia, vertigo, leg cramps, tardive dyskinesia^a, involuntary muscle contractions, paraesthesia, abnormal gait, bradykinesia, convulsions, hypokinesia, ataxia, fecal incontinence, oculogyric crisis, tetany, apraxia, dementia, migraine. *Rare:* neuroleptic malignant syndrome.

^a In the integrated database of multiple-dose studies (1499 patients with schizophrenia or schizoaffective disorder), 9 patients (0.6%) treated with RISPERDAL[®] CONSTA[®] (all dosages combined) experienced an adverse event of tardive dyskinesia.

Body as a Whole/General Disorders

Frequent: back pain, chest pain, asthenia. *Infrequent:* malaise, choking.

Gastrointestinal Disorders

Frequent: nausea, vomiting, abdominal pain. *Infrequent:* gastritis, gastroesophageal reflux, flatulence, hemorrhoids, melena, dysphagia, rectal hemorrhage, stomatitis, colitis, gastric ulcer, gingivitis, irritable bowel syndrome, ulcerative stomatitis.

Respiratory System Disorders

Frequent: dyspnea. *Infrequent:* pneumonia, stridor, hemoptysis. *Rare:* pulmonary edema.

Skin and Appendage Disorders

Frequent: rash. *Infrequent:* eczema, pruritus, erythematous rash, dermatitis, alopecia, seborrhea, photosensitivity reaction, increased sweating.

Metabolic and Nutritional Disorders

Infrequent: hyperuricemia, hyperglycemia, hyperlipemia, hypokalemia, glycosuria, hypercholesterolemia, obesity, dehydration, diabetes mellitus, hyponatremia.

Musculo-Skeletal System Disorders

Frequent: arthralgia, skeletal pain. *Infrequent:* torticollis, arthrosis, muscle weakness, tendinitis, arthritis, arthropathy.

Heart Rate and Rhythm Disorders

Frequent: tachycardia. *Infrequent:* bradycardia, AV block, palpitation, bundle branch block. *Rare:* T-wave inversion.

Cardiovascular Disorders

Frequent: hypotension. *Infrequent:* postural hypotension.

Urinary System Disorders

Frequent: urinary incontinence. *Infrequent:* hematuria, micturition frequency, renal pain, urinary retention.

Vision Disorders

Infrequent: conjunctivitis, eye pain, abnormal accommodation.

Reproductive Disorders, Female

Frequent: amenorrhea. *Infrequent:* nonpuerperal lactation, vaginitis, dysmenorrhea, breast pain, leukorrhea.

Resistance Mechanism Disorders

Infrequent: abscess.

Liver and Biliary System Disorders

Frequent: increased hepatic enzymes. *Infrequent:* hepatomegaly, increased SGPT. *Rare:* bilirubinemia, increased GGT, hepatitis, hepatocellular damage, jaundice, fatty liver, increased SGOT.

Reproductive Disorders, Male

Infrequent: ejaculation failure.

Application Site Disorders

Frequent: injection site pain. *Infrequent:* injection site reaction.

Hearing and Vestibular Disorders

Infrequent: earache, deafness, hearing decreased.

Red Blood Cell Disorders

Frequent: anemia.

White Cell and Resistance Disorders

Infrequent: lymphadenopathy, leucopenia, cervical lymphadenopathy.

Rare: granulocytopenia, leukocytosis, lymphopenia.

Endocrine Disorders

Infrequent: hyperprolactinemia, gynecomastia, hypothyroidism.

Platelet, Bleeding and Clotting Disorders

Infrequent: purpura, epistaxis. *Rare:* pulmonary embolism, hematoma, thrombocytopenia.

Myo-, Endo-, and Pericardial and Valve Disorders

Infrequent: myocardial ischemia, angina pectoris, myocardial infarction.

Vascular (Extracardiac) Disorders

Infrequent: phlebitis. *Rare:* intermittent claudication, flushing, thrombophlebitis.

Postintroduction Reports

Adverse events reported since market introduction which were temporally (but not necessarily causally) related to oral RISPERDAL[®] therapy include the following: anaphylactic reaction, angioedema, apnea, atrial fibrillation, cerebrovascular disorder, including cerebrovascular accident, diabetes mellitus aggravated, including diabetic ketoacidosis, hyperglycemia, intestinal obstruction, jaundice, mania, pancreatitis, Parkinson's disease aggravated, pituitary adenomas, pulmonary embolism, and QT prolongation. There have been rare reports of sudden death and/or cardiopulmonary arrest in patients receiving oral RISPERDAL[®]. A causal relationship with oral RISPERDAL[®] has not been established. It is important to note that sudden and unexpected death may occur in psychotic patients whether they remain untreated or whether they are treated with other antipsychotic drugs.

Retinal artery occlusion after injection of RISPERDAL[®] CONSTA[®] has been reported during postmarketing surveillance. This has been reported in the presence of abnormal arteriovenous anastomosis.

DRUG ABUSE AND DEPENDENCE

Controlled Substance Class

RISPERDAL[®] CONSTA[™] (risperidone) is not a controlled substance.

Physical and Psychological Dependence

RISPERDAL[®] CONSTA[®] has not been systematically studied in animals or humans for its potential for abuse, tolerance, or physical dependence. Because RISPERDAL[®] CONSTA[®] is to be administered by health care professionals, the potential for misuse or abuse by patients is low.

OVERDOSAGE

Human Experience

No cases of overdose were reported in premarketing studies with RISPERDAL[®] CONSTA[®] (risperidone). Because RISPERDAL[®] CONSTA[®] is to be administered by health care professionals, the potential for overdose by patients is low.

In premarketing experience with oral RISPERDAL[®] (risperidone), there were eight reports of acute RISPERDAL[®] overdose, with estimated doses ranging from 20 to 300 mg and no fatalities. In general, reported signs and symptoms were those resulting from an exaggeration of the drug's known pharmacological effects, i.e., drowsiness and sedation, tachycardia and hypotension, and extrapyramidal symptoms. One case, involving an estimated overdose of 240 mg, was associated with hyponatremia, hypokalemia, prolonged QT, and widened QRS. Another case, involving an estimated overdose of 36 mg, was associated with a seizure.

Postmarketing experience with oral RISPERDAL[®] includes reports of acute overdose, with estimated doses of up to 360 mg. In general, the most frequently reported signs and symptoms are those resulting from an exaggeration of the drug's known pharmacological effects, i.e., drowsiness, sedation, tachycardia, hypotension, and extrapyramidal symptoms. Other adverse events reported since market introduction which were temporally (but not necessarily causally) related to oral RISPERDAL[®] overdose include torsades de pointes, prolonged QT interval, convulsions, cardiopulmonary arrest, and rare fatality associated with multiple drug overdose.

Management of Overdosage

In case of acute overdose, establish and maintain an airway and ensure adequate oxygenation and ventilation. Cardiovascular monitoring should commence immediately and should include continuous electrocardiographic monitoring to detect possible arrhythmias. If antiarrhythmic therapy is administered, disopyramide, procainamide, and quinidine carry a theoretical hazard of QT prolonging effects that might be additive to those of risperidone. Similarly, it is reasonable to expect that the alpha-blocking properties of bretylium might be additive to those of risperidone, resulting in problematic hypotension.

There is no specific antidote to oral RISPERDAL[®]. Therefore, appropriate supportive measures should be instituted. The possibility of multiple drug involvement should be considered. Hypotension and circulatory collapse should be treated with appropriate measures, such as intravenous fluids and/or sympathomimetic agents (epinephrine and dopamine should not be used, since beta stimulation may worsen hypotension in the setting of risperidone-induced alpha blockade). In cases of severe extrapyramidal symptoms, anticholinergic medication should be administered. Close medical supervision and monitoring should continue until the patient recovers.

DOSAGE AND ADMINISTRATION

For patients who have never taken oral RISPERDAL[®], it is recommended to establish tolerability with oral RISPERDAL[®] prior to initiating treatment with RISPERDAL[®] CONSTA[®] (risperidone).

RISPERDAL[®] CONSTA[®] should be administered every 2 weeks by deep intramuscular (IM) gluteal injection. Each injection should be administered by a health care professional using the enclosed safety needle (see [HOW SUPPLIED](#)). Injections should alternate between the two buttocks. Do not administer intravenously.

The recommended dose is 25 mg IM every 2 weeks. Although dose response for effectiveness has not been established for RISPERDAL[®] CONSTA[®], some patients not responding to 25 mg may benefit from a higher dose of 37.5 mg or 50 mg. The maximum dose should not exceed 50 mg RISPERDAL[®] CONSTA[®] every 2 weeks. No additional benefit was observed with dosages greater than 50 mg RISPERDAL[®] CONSTA[®]; however, a higher incidence of adverse effects was observed.

A lower initial dose of 12.5 mg may be appropriate when clinical factors warrant dose adjustment, such as in patients with hepatic or renal impairment, for certain drug interactions that increase risperidone plasma concentrations (see PRECAUTIONS - Drug Interactions), or in patients who have a history of poor tolerability to psychotropic medications. The efficacy of the 12.5 mg dose has not been investigated in clinical trials.

Oral RISPERDAL[®] (or another antipsychotic medication) should be given with the first injection of RISPERDAL[®] CONSTA[®] and continued for 3 weeks (and then discontinued) to ensure that adequate therapeutic plasma concentrations are maintained prior to the main release phase of risperidone from the injection site (see [CLINICAL PHARMACOLOGY](#)).

Upward dosage adjustment should not be made more frequently than every 4 weeks. The clinical effects of this dose adjustment should not be anticipated earlier than 3 weeks after the first injection with the higher dose.

In patients with clinical factors such as hepatic or renal impairment or certain drug interactions that increase risperidone plasma concentrations (see PRECAUTIONS – Drug Interactions), dose reduction as low as 12.5 mg may be appropriate. The efficacy of the 12.5 mg dose has not been investigated in clinical trials.

Do not combine two different dosage strengths of RISPERDAL[®] CONSTA[®] in a single administration.

Pediatric Use

RISPERDAL[®] CONSTA[®] has not been studied in children younger than 18 years old.

Dosage in Special Populations

For elderly patients treated with RISPERDAL[®] CONSTA[®], the recommended dosage is 25 mg IM every 2 weeks. Oral RISPERDAL[®] (or another antipsychotic medication) should be given with the first injection of RISPERDAL[®] CONSTA[®] and should be continued for 3 weeks to ensure that adequate therapeutic plasma concentrations are maintained prior to the main release phase of risperidone from the injection site (see [CLINICAL PHARMACOLOGY](#)).

Patients with renal or hepatic impairment should be treated with titrated doses of oral RISPERDAL[®] prior to initiating treatment with RISPERDAL[®] CONSTA[®]. The recommended starting dose is 0.5 mg oral RISPERDAL[®] b.i.d. during the first week, which can be increased to 1 mg b.i.d. or 2 mg once daily during the second week. If a total daily dose of at least 2 mg oral RISPERDAL[®] is well tolerated, an injection of 25 mg RISPERDAL[®] CONSTA[®] can be administered every 2 weeks. Alternatively, a starting dose of RISPERDAL[®] CONSTA[®] of 12.5 mg may be appropriate. The efficacy of the 12.5 mg dose has not been investigated in clinical trials.

Oral supplementation should be continued for 3 weeks after the first injection until the main release of risperidone from the injection site has begun. In some patients, slower titration may be medically appropriate.

Patients with renal impairment may have less ability to eliminate risperidone than normal adults. Patients with impaired hepatic function may have an increase in the free fraction of the risperidone, possibly resulting in an enhanced effect (see [CLINICAL PHARMACOLOGY](#)). Elderly patients and patients with a predisposition

to hypotensive reactions or for whom such reactions would pose a particular risk should be instructed in nonpharmacologic interventions that help to reduce the occurrence of orthostatic hypotension (e.g., sitting on the edge of the bed for several minutes before attempting to stand in the morning and slowly rising from a seated position). These patients should avoid sodium depletion or dehydration, and circumstances that accentuate hypotension (alcohol intake, high ambient temperature, etc.). Monitoring of orthostatic vital signs should be considered (see [PRECAUTIONS](#)).

Maintenance Therapy

Although no controlled studies have been conducted to answer the question of how long patients should be treated with RISPERDAL[®] CONSTA[®], oral risperidone has been shown to be effective in delaying time to relapse in longer-term use. It is recommended that responding patients be continued on treatment with RISPERDAL[®] CONSTA[®] at the lowest dose needed. Patients should be periodically reassessed to determine the need for continued treatment.

Reinitiation of Treatment in Patients Previously Discontinued

There are no data to specifically address reinitiation of treatment. When restarting patients who have had an interval off treatment with RISPERDAL[®] CONSTA[®], supplementation with oral RISPERDAL[®] (or another antipsychotic medication) should be administered.

Switching from Other Antipsychotics

There are no systematically collected data to specifically address switching schizophrenic patients from other antipsychotics to RISPERDAL[®] CONSTA[®], or concerning concomitant administration with other antipsychotics. Previous antipsychotics should be continued for 3 weeks after the first injection of RISPERDAL[®] CONSTA[®] to ensure that therapeutic concentrations are maintained until the main release phase of risperidone from the injection site has begun (see [CLINICAL PHARMACOLOGY](#)). For schizophrenic patients who have never taken oral RISPERDAL[®], it is recommended to establish tolerability with oral RISPERDAL[®] prior to initiating treatment with RISPERDAL[®] CONSTA[®]. As recommended with other antipsychotic medications, the need for continuing existing EPS medication should be re-evaluated periodically.

Co-Administration of RISPERDAL[®] CONSTA[®] with Certain Other Medications

Co-administration of carbamazepine and other CYP 3A4 enzyme inducers (e.g., phenytoin, rifampin, phenobarbital) with risperidone would be expected to cause

decreases in the plasma concentrations of active moiety (the sum of risperidone and 9-hydroxyrisperidone), which could lead to decreased efficacy of RISPERDAL® CONSTA® treatment. The dose of risperidone needs to be titrated accordingly for patients receiving these enzyme inducers, especially during initiation or discontinuation of therapy with these inducers (see [CLINICAL PHARMACOLOGY](#) and [PRECAUTIONS](#)). At the initiation of therapy with carbamazepine or other known CYP 3A4 hepatic enzyme inducers, patients should be closely monitored during the first 4-8 weeks, since the dose of RISPERDAL® CONSTA® may need to be adjusted. A dose increase, or additional oral RISPERDAL®, may need to be considered. On discontinuation of carbamazepine or other CYP 3A4 hepatic enzyme inducers, the dosage of RISPERDAL® CONSTA® should be re-evaluated and, if necessary, decreased. Patients may be placed on a lower dose of RISPERDAL® CONSTA® between 2 to 4 weeks before the planned discontinuation of carbamazepine or other CYP 3A4 enzyme inducers to adjust for the expected increase in plasma concentrations of risperidone plus 9-hydroxyrisperidone. For patients treated with the recommended dose of 25 mg RISPERDAL® CONSTA® and discontinuing from carbamazepine or other CYP 3A4 enzyme inducers, it is recommended to continue treatment with the 25-mg dose unless clinical judgment necessitates lowering the RISPERDAL® CONSTA® dose to 12.5 mg or necessitates interruption of RISPERDAL® CONSTA® treatment. The efficacy of the 12.5 mg dose has not been investigated in clinical trials.

Fluoxetine and paroxetine, CYP 2D6 inhibitors, have been shown to increase the plasma concentration of risperidone 2.5-2.8 fold and 3-9 fold respectively. Fluoxetine did not affect the plasma concentration of 9-hydroxyrisperidone. Paroxetine lowered the concentration of 9-hydroxyrisperidone by about 10%. The dose of risperidone needs to be titrated accordingly when fluoxetine or paroxetine is co-administered. When either concomitant fluoxetine or paroxetine is initiated or discontinued, the physician should re-evaluate the dose of RISPERDAL® CONSTA®. When initiation of fluoxetine or paroxetine is considered, patients may be placed on a lower dose of RISPERDAL® CONSTA® between 2 to 4 weeks before the planned start of fluoxetine or paroxetine therapy to adjust for the expected increase in plasma concentrations of risperidone. When fluoxetine and paroxetine is initiated in patients receiving the recommended dose of 25 mg RISPERDAL® CONSTA®, it is recommended to continue treatment with the 25-mg dose unless clinical judgment necessitates lowering the RISPERDAL® CONSTA® dose to 12.5 mg or necessitates interruption of RISPERDAL® CONSTA® treatment. When RISPERDAL® CONSTA® is initiated in patients already receiving fluoxetine or paroxetine, a

starting dose of 12.5 mg can be considered. The efficacy of the 12.5 mg dose has not been investigated in clinical trials. The effects of discontinuation of concomitant fluoxetine or paroxetine therapy on the pharmacokinetics of risperidone and 9-hydroxyrisperidone have not been studied.

Instructions for Use

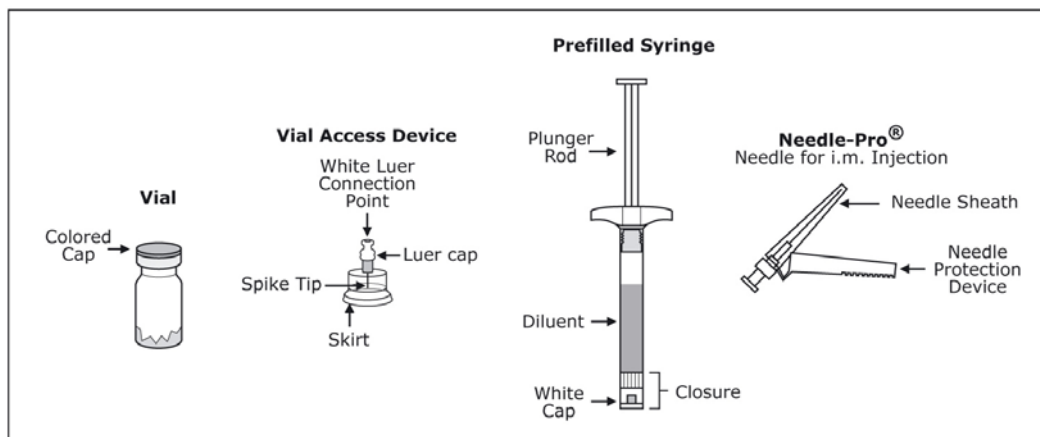

RISPERDAL® CONSTA® must be reconstituted **only** in the diluent supplied in the dose pack, and must be administered with the needle supplied in the dose pack. All components are required for administration. Do not substitute any components of the dose pack. To assure that the intended dose of risperidone is delivered, the full contents from the vial must be administered. Administration of partial contents may not deliver the intended dose of risperidone.

Remove the dose pack of **RISPERDAL® CONSTA®** from the refrigerator and allow it to come to room temperature prior to reconstitution.

1. Flip off the plastic colored cap from the vial.

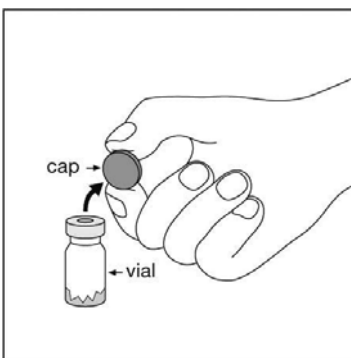

2. Peel back the blister pouch and remove the SmartSite[®] Needle-Free Vial Access Device by holding the white luer cap. Do **not** touch the spike tip of the access device at any time.

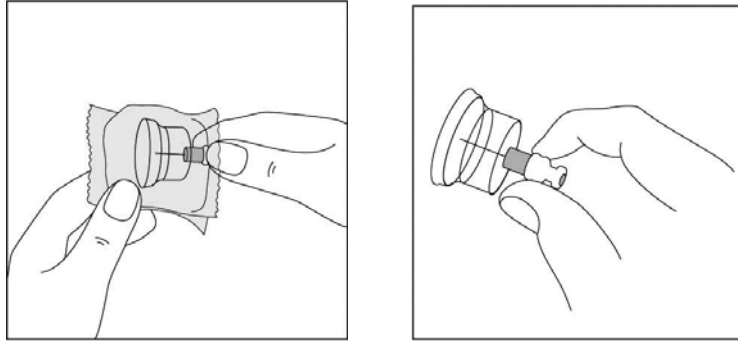

3. Place vial on a hard surface. Press the spike tip of the SmartSite[®] Access Device through the center of the vial's rubber stopper until the device securely snaps into place.



4. Swab the syringe connection point (blue circle) of the SmartSite[®] Access Device with preferred antiseptic prior to attaching the syringe to the SmartSite[®] Access Device.



- Twist off the white cap from the pre-filled syringe and remove together with the rubber tip cap inside.

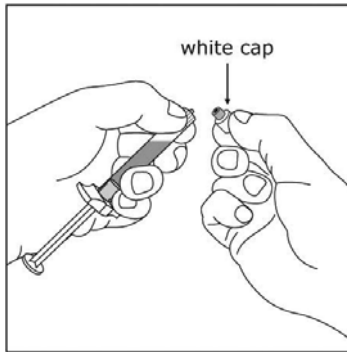

- Press** the syringe tip into the blue circle of the SmartSite[®] Access Device and **Twist** in a clockwise motion to ensure that the syringe is securely attached to the white luer cap of the access device. Keep the syringe and SmartSite[®] Access Device aligned, and hold the skirt of the access device during attachment to prevent spinning.

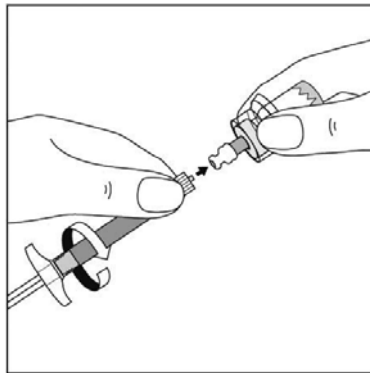

- Inject the entire contents of the syringe containing the diluent into the vial.

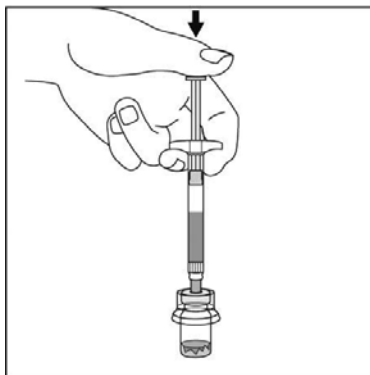

- Shake the vial vigorously while holding the plunger rod down with the thumb for a minimum of 10 seconds to ensure a homogeneous suspension. When properly

mixed, the suspension appears uniform, thick, and milky in color. The particles will be visible in liquid, but no dry particles remain.

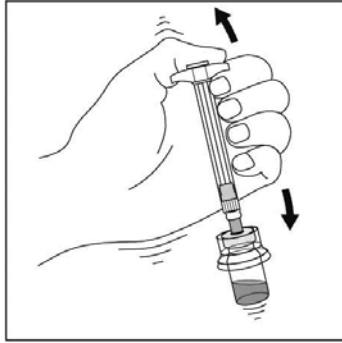

9. Do not store the vial after reconstitution or the suspension may settle. *If 2 minutes pass before injection, re-suspend by shaking vigorously.*
10. Invert the vial completely and slowly withdraw the suspension from the vial. Tear section of the vial label at the perforation and apply detached label to syringe for identification purposes.

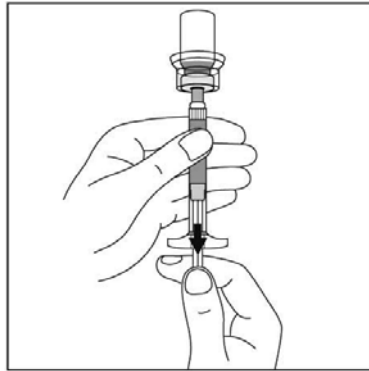

11. Unscrew the syringe from the SmartSite[®] access device and discard both the vial and access device appropriately.

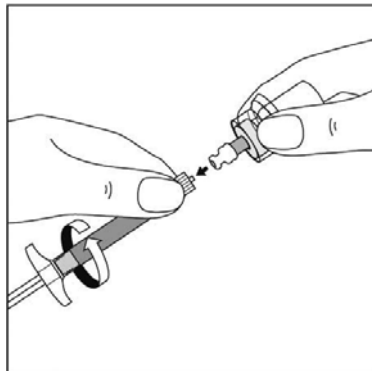

12. Peel the blister pouch of the Needle-Pro[®] device open halfway. Grasp sheath using the plastic peel pouch.

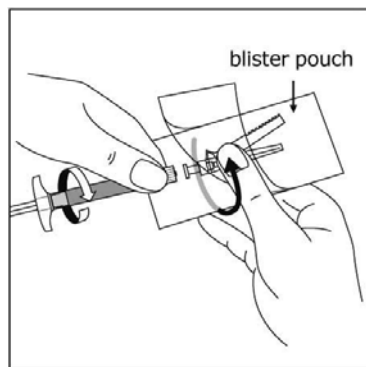

13. Attach the luer connection of the Needle-Pro[®] device to the syringe with an easy clockwise twisting motion. Seat the needle firmly on the Needle-Pro[®] device with a push and clockwise twist.
14. *If 2 minutes pass before injection, re-suspend by shaking vigorously.*
15. Pull sheath away from the needle. Do not twist sheath, as needle may be loosened from Needle-Pro[®] device. Tap the syringe gently to make any air bubbles rise to the top. De-aerate syringe by moving plunger rod carefully forward, with needle in an upward position. Inject entire contents intramuscularly (IM) into the upper-outer quadrant of the gluteal area within 2 minutes to avoid settling. **DO NOT ADMINISTER INTRAVENOUSLY.**

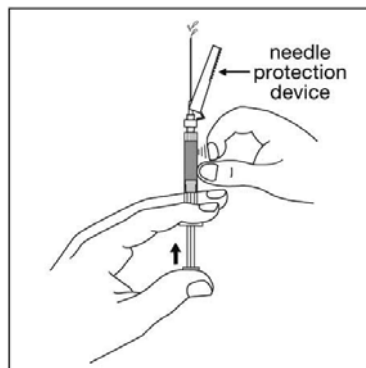

WARNING: To avoid a needle stick injury with a contaminated needle, do not:

- intentionally disengage the Needle-Pro[®] device
 - attempt to straighten the needle or engage Needle-Pro[®] device if the needle is bent or damaged
 - mishandle the needle protection device that could lead to protrusion of the needle from it
16. After injection is complete, use only one hand and tabletop or other hard surface to snap needle into the orange needle protector device before discarding. Discard needle appropriately.

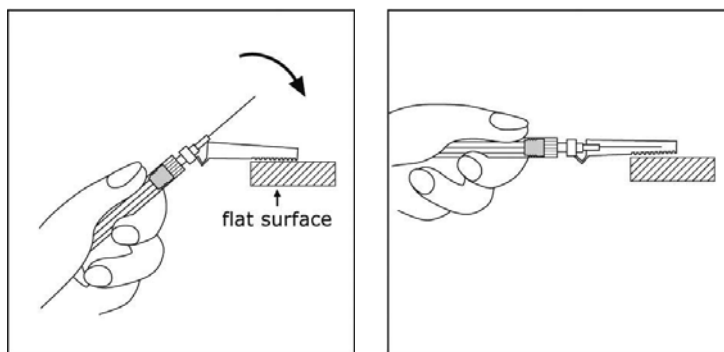

Upon suspension in the diluent, it is recommended to use RISPERDAL[®] CONSTA[®] immediately. RISPERDAL[®] CONSTA[®] must be used within 6 hours of suspension. Resuspension of RISPERDAL[®] CONSTA[®] will be necessary prior to administration, as settling will occur over time once the product is in suspension. Keeping the vial upright, shake vigorously back and forth for as long as it takes to resuspend the microspheres. Once in suspension, the product should not be exposed to temperatures above 77°F (25°C).

Parenteral drug products should be inspected visually for particulate matter and discoloration prior to administration, whenever solution and container permit.

HOW SUPPLIED

RISPERDAL[®] CONSTA[®] (risperidone) is available in dosage strengths of 12.5, 25, 37.5, or 50 mg risperidone. It is provided as a dose pack, consisting of a vial containing the risperidone microspheres, a pre-filled syringe containing 2 mL of diluent for RISPERDAL[®] CONSTA[®], a SmartSite[®] Needle-Free Vial Access Device, and one Needle-Pro[®] safety needle for intramuscular injection (20 G TW needle with needle protection device).

12.5-mg vial/kit (NDC 50458-309-11): 12.5 mg of a white to off-white powder provided in a vial with a violet flip-off cap (NDC 50458-309-01).

25-mg vial/kit (NDC 50458-306-11): 25 mg of a white to off-white powder provided in a vial with a pink flip-off cap (NDC 50458-306-01).

37.5-mg vial/kit (NDC 50458-307-11): 37.5 mg of a white to off-white powder provided in a vial with a green flip-off cap (NDC 50458-307-01).

50-mg vial/kit (NDC 50458-308-11): 50 mg of a white to off-white powder provided in a vial with a blue flip-off cap (NDC 50458-308-01).

Storage and Handling

The entire dose pack should be stored in the refrigerator (36°- 46°F; 2°- 8°C) and protected from light.

If refrigeration is unavailable, RISPERDAL[®] CONSTA[®] can be stored at temperatures not exceeding 77°F (25°C) for no more than 7 days prior to administration. Do not expose unrefrigerated product to temperatures above 77°F (25°C).

Keep out of reach of children.

7519507

Revised April 2007

©Janssen 2003

Risperidone is manufactured by:
Janssen Pharmaceutical Ltd.
Wallingstown, Little Island, County Cork, Ireland

Microspheres are manufactured by:
Alkermes Controlled Therapeutics II
Wilmington, Ohio

Diluent is manufactured by:
Vetter Pharma Fertigung GmbH & Co. KG
Ravensburg, Germany

RISPERDAL CONSTA[®] is distributed by:
Janssen , L.P.
Titusville, NJ 08560