

HIGHLIGHTS OF PRESCRIBING INFORMATION

These highlights do not include all the information needed to use RISPERDAL[®] CONSTA[®] safely and effectively. See full prescribing information for RISPERDAL[®] CONSTA[®].

RISPERDAL[®] CONSTA[®] (risperidone) LONG-ACTING INJECTION

Initial U.S. Approval: 2003

WARNING: INCREASED MORTALITY IN ELDERLY PATIENTS WITH DEMENTIA-RELATED PSYCHOSIS

See full prescribing information for complete boxed warning.

Elderly patients with dementia-related psychosis treated with antipsychotic drugs are at an increased risk of death. RISPERDAL[®] CONSTA[®] is not approved for use in patients with dementia-related psychosis. (5.1)

RECENT MAJOR CHANGES

Boxed Warning	Month YYYY
Warnings and Precautions (5.1)	Month YYYY
Warnings and Precautions, Priapism (5.11)	Month YYYY

INDICATIONS AND USAGE

RISPERDAL[®] CONSTA[®] is an atypical antipsychotic agent indicated for the treatment of schizophrenia.

DOSAGE AND ADMINISTRATION

- For patients who have never taken oral RISPERDAL[®], tolerability should be established with oral RISPERDAL[®] prior to initiating treatment with RISPERDAL[®] CONSTA[®] (2)
- Administer by deep intramuscular (IM) deltoid or gluteal injection. Each injection should be administered by a health care professional using the appropriate enclosed safety needle (1-inch for deltoid administration alternating injections between the two arms and 2-inch for gluteal administration alternating injections between the two buttocks). Do not administer intravenously. (2)
- 25 mg intramuscular (IM) every 2 weeks. Patients not responding to 25 mg may benefit from a higher dose of 37.5 mg or 50 mg. The maximum dose should not exceed 50 mg every 2 weeks. (2)
- Oral RISPERDAL[®] (or another antipsychotic medication) should be given with the first injection of RISPERDAL[®] CONSTA[®], and continued for 3 weeks (and then discontinued) to ensure adequate therapeutic plasma concentrations from RISPERDAL[®] CONSTA[®]. (2)
- Upward dose adjustment of RISPERDAL[®] CONSTA[®] should not be made more frequently than every 4 weeks. Clinical effects of each upward dose adjustment should not be anticipated earlier than 3 weeks after injection. (2)
- Avoid inadvertent administration into a blood vessel. (5.14)
- See Full Prescribing Information Section 2.6 for instructions for use.

DOSAGE FORMS AND STRENGTHS

Vial kits: 12.5, 25, 37.5, and 50 mg (3)

CONTRAINDICATIONS

- Known hypersensitivity to the product (4)

WARNINGS AND PRECAUTIONS

- Cerebrovascular events, including stroke, in elderly patients with dementia-related psychosis. RISPERDAL[®] is not approved for use in patients with dementia-related psychosis (5.2)
- Neuroleptic Malignant Syndrome: Manage with immediate discontinuation and close monitoring (5.3)
- Tardive Dyskinesia: Discontinue treatment if clinically appropriate (5.4)
- Hyperglycemia and Diabetes Mellitus- in some cases extreme and associated with ketoacidosis or hyperosmolar coma or death, has been reported in patients taking risperidone. Patients with diabetes mellitus should have glucose levels monitored regularly. Patients with risk factors for diabetes mellitus should undergo fasting glucose testing at the beginning of treatment and periodically during treatment. All patients taking risperidone should be monitored for symptoms of hyperglycemia. Symptomatic patients should undergo fasting glucose testing. (5.5)

- Hyperprolactinemia: Risperidone treatment may elevate prolactin levels. Long-standing hyperprolactinemia, when associated with hypogonadism, can lead to decreased bone density in men and women. (5.6)
- Orthostatic hypotension: associated with dizziness, tachycardia, bradycardia, and syncope can occur, especially during initial dose titration with oral risperidone. Use caution in patients with cardiovascular disease, cerebrovascular disease, and conditions that could affect hemodynamic responses. (5.7)
- Potential for cognitive and motor impairment: has potential to impair judgment, thinking, and motor skills. Use caution when operating machinery, including automobiles. (5.8)
- Seizures: Use cautiously in patients with a history of seizures or with conditions that potentially lower the seizure threshold. (5.9)
- Dysphagia: Esophageal dysmotility and aspiration can occur. Use cautiously in patients at risk for aspiration pneumonia. (5.10)
- Priapism: has been reported. Severe priapism may require surgical intervention. (5.11)
- Thrombotic Thrombocytopenic Purpura (TTP): has been reported. (5.12)
- Avoid inadvertent administration into a blood vessel (5.14)
- Suicide: The possibility of a suicide attempt is inherent in Schizophrenia. Close supervision of high-risk patients should accompany drug therapy. (5.16)
- Increased sensitivity in patients with Parkinson's disease or those with dementia with Lewy bodies: has been reported. Manifestations include mental status changes, motor impairment, extrapyramidal symptoms, and features consistent with Neuroleptic Malignant Syndrome. (5.17)
- Diseases or conditions that could affect metabolism or hemodynamic responses: Use with caution in patients with such medical conditions (e.g., recent myocardial infarction or unstable cardiac disease) (5.17)

ADVERSE REACTIONS

The most common adverse reactions in clinical trials ($\geq 5\%$) were: headache, parkinsonism, dizziness, akathisia, fatigue, constipation, dyspepsia, sedation, weight increased, pain in extremity, and dry mouth. (6)

The most common adverse reactions that were associated with discontinuation from clinical trials were agitation, depression, anxiety, and akathisia. (6)

To report SUSPECTED ADVERSE REACTIONS, contact Janssen, L.P. at 1-800-JANSSEN (1-800-526-7736) or FDA at 1-800-FDA-1088 or www.fda.gov/medwatch

DRUG INTERACTIONS

- Due to CNS effects, use caution when administering with other centrally-acting drugs. Avoid alcohol. (7.1)
- Due to hypotensive effects, hypotensive effects of other drugs with this potential may be enhanced. (7.2)
- Effects of levodopa and dopamine agonists may be antagonized. (7.3)
- Cimetidine and ranitidine increase the bioavailability of risperidone. (7.5)
- Clozapine may decrease clearance of risperidone. (7.6)
- Fluoxetine and paroxetine increase plasma concentrations of risperidone. (7.11)
- Carbamazepine and other enzyme inducers decrease plasma concentrations of risperidone. (7.12)

USE IN SPECIFIC POPULATIONS

- Renal or Hepatic Impairment: dose appropriately with oral RISPERDAL[®] prior to initiating treatment with RISPERDAL[®] CONSTA[®]. A lower starting dose of RISPERDAL[®] CONSTA[®] of 12.5 mg may be appropriate in some patients. (2.1)
- Nursing Mothers: should not breast feed. (8.3)
- Pediatric Use: safety and effectiveness not established in patients less than 18 years of age. (8.4)
- Elderly: dosing for otherwise healthy elderly patients is the same as for healthy nonelderly. Elderly may be more predisposed to orthostatic effects than nonelderly. (8.5)

See 17 for PATIENT COUNSELING INFORMATION.

Revised: Month YYYY

FULL PRESCRIBING INFORMATION: CONTENTS*

WARNINGS – INCREASED MORTALITY IN ELDERLY PATIENTS WITH DEMENTIA-RELATED PSYCHOSIS

1 INDICATIONS AND USAGE

2 DOSAGE AND ADMINISTRATION

2.1 Dosage in Special Populations

2.2 Maintenance Therapy

2.3 Reinitiation of Treatment in Patients Previously Discontinued

2.4 Switching from Other Antipsychotics

2.5 Co-Administration of RISPERDAL[®] CONSTA[®] with Certain Other Medications

2.6 Instructions for Use

3 DOSAGE FORMS AND STRENGTHS

4 CONTRAINDICATIONS

5 WARNINGS AND PRECAUTIONS

5.1 Increased Mortality in Elderly Patients with Dementia-Related Psychosis

5.2 Cerebrovascular Adverse Events, Including Stroke, in Elderly Patients with Dementia-Related Psychosis

5.3 Neuroleptic Malignant Syndrome (NMS)

5.4 Tardive Dyskinesia

5.5 Hyperglycemia and Diabetes Mellitus

5.6 Hyperprolactinemia

5.7 Orthostatic Hypotension

5.8 Potential for Cognitive and Motor Impairment

5.9 Seizures

5.10 Dysphagia

5.11 Priapism

5.12 Thrombotic Thrombocytopenic Purpura (TTP)

5.13 Body Temperature Regulation

5.14 Administration

5.15 Antiemetic Effect

5.16 Suicide

5.17 Use in Patients with Concomitant Illness

5.18 Osteodystrophy and Tumors in Animals

5.19 Monitoring: Laboratory Tests

6 ADVERSE REACTIONS

6.1 Commonly-Observed Adverse Reactions in Double-Blind, Placebo-Controlled Clinical Trials

6.2 Other Adverse Reactions Observed During the Premarketing Evaluation of RISPERDAL[®] CONSTA[®]

6.3 Discontinuations Due to Adverse Reactions

6.4 Dose Dependency of Adverse Reactions in Clinical Trials

6.5 Changes in Body Weight

6.6 Changes in ECG

6.7 Pain Assessment and Local Injection Site Reactions

6.8 Postmarketing Experience

7 DRUG INTERACTIONS

7.1 Centrally-Acting Drugs and Alcohol

7.2 Drugs with Hypotensive Effects

7.3 Levodopa and Dopamine Agonists

7.4 Amitriptyline

7.5 Cimetidine and Ranitidine

7.6 Clozapine

7.7 Lithium

7.8 Valproate

7.9 Digoxin

7.10 Topiramate

7.11 Drugs That Inhibit CYP 2D6 and Other CYP Isozymes

7.12 Carbamazepine and Other CYP 3A4 Enzyme Inducers

7.13 Drugs Metabolized by CYP 2D6

8 USE IN SPECIFIC POPULATIONS

8.1 Pregnancy

8.2 Labor and Delivery

8.3 Nursing Mothers

8.4 Pediatric Use

8.5 Geriatric Use

9 DRUG ABUSE AND DEPENDENCE

9.1 Controlled Substance

9.2 Abuse

9.3 Dependence

10 OVERDOSAGE

10.1 Human Experience

10.2 Management of Overdosage

11 DESCRIPTION

12 CLINICAL PHARMACOLOGY

12.1 Mechanism of Action

12.2 Pharmacodynamics

12.3 Pharmacokinetics

13 NONCLINICAL TOXICOLOGY

13.1 Carcinogenesis, Mutagenesis, Impairment of Fertility

14 CLINICAL STUDIES

16 HOW SUPPLIED/STORAGE AND HANDLING

17 PATIENT COUNSELING INFORMATION

17.1 Orthostatic Hypotension

17.2 Interference with Cognitive and Motor Performance

17.3 Pregnancy

17.4 Nursing

17.5 Concomitant Medication

17.6 Alcohol

*Sections or subsections omitted from the full prescribing information are not listed

FULL PRESCRIBING INFORMATION

WARNING: INCREASED MORTALITY IN ELDERLY PATIENTS WITH DEMENTIA-RELATED PSYCHOSIS

Elderly patients with dementia-related psychosis treated with antipsychotic drugs are at an increased risk of death. Analyses of 17 placebo-controlled trials (modal duration of 10 weeks), largely in patients taking atypical antipsychotic drugs, revealed a risk of death in drug-treated patients of between 1.6 to 1.7 times the risk of death in placebo-treated patients. Over the course of a typical 10-week controlled trial, the rate of death in drug-treated patients was about 4.5%, compared to a rate of about 2.6% in the placebo group. Although the causes of death were varied, most of the deaths appeared to be either cardiovascular (e.g., heart failure, sudden death) or infectious (e.g., pneumonia) in nature. Observational studies suggest that, similar to atypical antipsychotic drugs, treatment with conventional antipsychotic drugs may increase mortality. The extent to which the findings of increased mortality in observational studies may be attributed to the antipsychotic drug as opposed to some characteristic(s) of the patients is not clear. RISPERDAL[®] CONSTA[®] (risperidone) is not approved for the treatment of patients with dementia-related psychosis. [See *Warnings and Precautions (5.1)*]

1 INDICATIONS AND USAGE

RISPERDAL[®] CONSTA[®] (risperidone) is indicated for the treatment of schizophrenia [see *Clinical Studies (14)*].

2 DOSAGE AND ADMINISTRATION

For patients who have never taken oral RISPERDAL[®], it is recommended to establish tolerability with oral RISPERDAL[®] prior to initiating treatment with RISPERDAL[®] CONSTA[®].

RISPERDAL[®] CONSTA[®] should be administered every 2 weeks by deep intramuscular (IM) deltoid or gluteal injection. Each injection should be administered by a health care professional using the appropriate enclosed safety needle [see *Dosage and Administration (2.6)*]. For deltoid administration, use the 1-inch needle alternating injections between the two arms. For gluteal administration, use the 2-inch needle alternating injections between the two buttocks. Do not administer intravenously.

The recommended dose is 25 mg IM every 2 weeks. Although dose response for effectiveness has not been established for RISPERDAL[®] CONSTA[®], some patients not responding to 25 mg may benefit from a higher dose of 37.5 mg or 50 mg. The maximum dose should not exceed 50 mg RISPERDAL[®] CONSTA[®] every 2 weeks. No additional benefit was observed with dosages greater than 50 mg RISPERDAL[®] CONSTA[®]; however, a higher incidence of adverse effects was observed.

A lower initial dose of 12.5 mg may be appropriate when clinical factors warrant dose adjustment, such as in patients with hepatic or renal impairment, for certain drug interactions that increase risperidone plasma concentrations [see *DRUG INTERACTIONS (7.11)*] or in patients who have a history of poor tolerability to psychotropic medications. The efficacy of the 12.5 mg dose has not been investigated in clinical trials.

Oral RISPERDAL[®] (or another antipsychotic medication) should be given with the first injection of RISPERDAL[®] CONSTA[®] and continued for 3 weeks (and then discontinued) to ensure that adequate therapeutic plasma concentrations are maintained prior to the main release phase of risperidone from the injection site [see *Clinical Pharmacology (12.3)*].

Upward dose adjustment should not be made more frequently than every 4 weeks. The clinical effects of this dose adjustment should not be anticipated earlier than 3 weeks after the first injection with the higher dose.

In patients with clinical factors such as hepatic or renal impairment or certain drug interactions that increase risperidone plasma concentrations [see *DRUG INTERACTIONS (7.11)*], dose reduction as low as 12.5 mg may be appropriate. The efficacy of the 12.5 mg dose has not been investigated in clinical trials.

Do not combine two different dose strengths of RISPERDAL[®] CONSTA[®] in a single administration.

The efficacy of RISPERDAL[®] CONSTA[®] has not been evaluated in controlled clinical trials for longer than 12 weeks. Therefore, the physician who elects to use RISPERDAL[®] CONSTA[®] for extended periods should periodically re-evaluate the long-term risks and benefits of the drug for the individual patient.

2.1 Dosage in Special Populations

Elderly

For elderly patients treated with RISPERDAL[®] CONSTA[®], the recommended dosage is 25 mg IM every 2 weeks. Oral RISPERDAL[®] (or another antipsychotic medication) should be given with the first injection of RISPERDAL[®] CONSTA[®] and should be continued for 3 weeks to ensure that adequate therapeutic plasma concentrations are maintained prior to the main release phase of risperidone from the injection site [see *Clinical Pharmacology (12.3)*].

Renal or Hepatic Impairment

Patients with renal or hepatic impairment should be treated with titrated doses of oral RISPERDAL[®] prior to initiating treatment with RISPERDAL[®] CONSTA[®]. The

recommended starting dose is 0.5 mg oral RISPERDAL[®] twice daily during the first week, which can be increased to 1 mg twice daily or 2 mg once daily during the second week. If a total daily dose of at least 2 mg oral RISPERDAL[®] is well tolerated, an injection of 25 mg RISPERDAL[®] CONSTA[®] can be administered every 2 weeks. Oral supplementation should be continued for 3 weeks after the first injection until the main release of risperidone from the injection site has begun. In some patients, slower titration may be medically appropriate. Alternatively, a starting dose of RISPERDAL[®] CONSTA[®] of 12.5 mg may be appropriate. The efficacy of the 12.5 mg dose has not been investigated in clinical trials.

Patients with renal impairment may have less ability to eliminate risperidone than normal adults. Patients with impaired hepatic function may have an increase in the free fraction of the risperidone, possibly resulting in an enhanced effect [*see Clinical Pharmacology (12.3)*]. Elderly patients and patients with a predisposition to hypotensive reactions or for whom such reactions would pose a particular risk should be instructed in nonpharmacologic interventions that help to reduce the occurrence of orthostatic hypotension (e.g., sitting on the edge of the bed for several minutes before attempting to stand in the morning and slowly rising from a seated position). These patients should avoid sodium depletion or dehydration, and circumstances that accentuate hypotension (alcohol intake, high ambient temperature, etc.). Monitoring of orthostatic vital signs should be considered [*see Warnings and Precautions (5.9)*].

2.2 Maintenance Therapy

Although no controlled studies have been conducted to answer the question of how long patients should be treated with RISPERDAL[®] CONSTA[®], oral risperidone has been shown to be effective in delaying time to relapse in longer-term use. It is recommended that responding patients be continued on treatment with RISPERDAL[®] CONSTA[®] at the lowest dose needed. Patients should be periodically reassessed to determine the need for continued treatment.

2.3 Reinitiation of Treatment in Patients Previously Discontinued

There are no data to specifically address reinitiation of treatment. When restarting patients who have had an interval off treatment with RISPERDAL[®] CONSTA[®], supplementation with oral RISPERDAL[®] (or another antipsychotic medication) should be administered.

2.4 Switching from Other Antipsychotics

There are no systematically collected data to specifically address switching schizophrenic patients from other antipsychotics to RISPERDAL[®] CONSTA[®], or concerning concomitant administration with other antipsychotics. Previous antipsychotics should be continued for

3 weeks after the first injection of RISPERDAL[®] CONSTA[®] to ensure that therapeutic concentrations are maintained until the main release phase of risperidone from the injection site has begun [see *Clinical Pharmacology (12.3)*]. For schizophrenic patients who have never taken oral RISPERDAL[®], it is recommended to establish tolerability with oral RISPERDAL[®] prior to initiating treatment with RISPERDAL[®] CONSTA[®]. As recommended with other antipsychotic medications, the need for continuing existing EPS medication should be re-evaluated periodically.

2.5 Co-Administration of RISPERDAL[®] CONSTA[®] with Certain Other Medications

Co-administration of carbamazepine and other CYP 3A4 enzyme inducers (e.g., phenytoin, rifampin, phenobarbital) with risperidone would be expected to cause decreases in the plasma concentrations of the sum of risperidone and 9-hydroxyrisperidone combined, which could lead to decreased efficacy of RISPERDAL[®] CONSTA[®] treatment. The dose of risperidone needs to be titrated accordingly for patients receiving these enzyme inducers, especially during initiation or discontinuation of therapy with these inducers [see *Drug Interactions (7.11)*]. At the initiation of therapy with carbamazepine or other known CYP 3A4 hepatic enzyme inducers, patients should be closely monitored during the first 4-8 weeks, since the dose of RISPERDAL[®] CONSTA[®] may need to be adjusted. A dose increase, or additional oral RISPERDAL[®], may need to be considered. On discontinuation of carbamazepine or other CYP 3A4 hepatic enzyme inducers, the dosage of RISPERDAL[®] CONSTA[®] should be re-evaluated and, if necessary, decreased. Patients may be placed on a lower dose of RISPERDAL[®] CONSTA[®] between 2 to 4 weeks before the planned discontinuation of carbamazepine or other CYP 3A4 inducers to adjust for the expected increase in plasma concentrations of risperidone plus 9-hydroxyrisperidone. For patients treated with the recommended dose of 25 mg RISPERDAL[®] CONSTA[®] and discontinuing from carbamazepine or other CYP3A4 enzyme inducers, it is recommended to continue treatment with the 25-mg dose unless clinical judgment necessitates lowering the RISPERDAL[®] CONSTA[®] dose to 12.5 mg or necessitates interruption of RISPERDAL[®] CONSTA[®] treatment. The efficacy of the 12.5 mg dose has not been investigated in clinical trials.

Fluoxetine and paroxetine, CYP 2D6 inhibitors, have been shown to increase the plasma concentration of risperidone 2.5-2.8 fold and 3-9 fold respectively. Fluoxetine did not affect the plasma concentration of 9-hydroxyrisperidone. Paroxetine lowered the concentration of 9-hydroxyrisperidone by about 10%. The dose of risperidone needs to be titrated accordingly when fluoxetine or paroxetine is co-administered. When either concomitant fluoxetine or paroxetine is initiated or discontinued, the physician should re-evaluate the

dose of RISPERDAL[®] CONSTA[®]. When initiation of fluoxetine or paroxetine is considered, patients may be placed on a lower dose of RISPERDAL[®] CONSTA[®] between 2 to 4 weeks before the planned start of fluoxetine or paroxetine therapy to adjust for the expected increase in plasma concentrations of risperidone. When fluoxetine or paroxetine is initiated in patients receiving the recommended dose of 25 mg RISPERDAL[®] CONSTA[®], it is recommended to continue treatment with the 25-mg dose unless clinical judgment necessitates lowering the RISPERDAL[®] CONSTA[®] dose to 12.5 mg or necessitates interruption of RISPERDAL[®] CONSTA[®] treatment. When RISPERDAL[®] CONSTA[®] is initiated in patients already receiving fluoxetine or paroxetine, a starting dose of 12.5 mg can be considered. The efficacy of the 12.5 mg dose has not been investigated in clinical trials. The effects of discontinuation of concomitant fluoxetine or paroxetine therapy on the pharmacokinetics of risperidone and 9-hydroxyrisperidone have not been studied. [See Drug Interactions (7.11)]

2.6 Instructions for Use

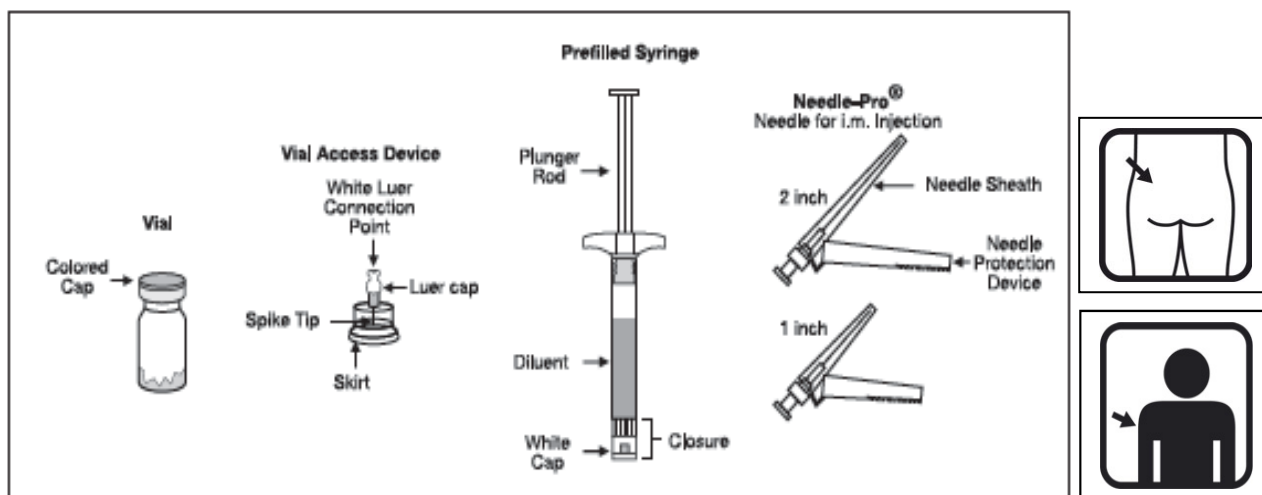

RISPERDAL[®] CONSTA[®] must be reconstituted **only** in the diluent supplied in the dose pack, and must be administered with **only** the appropriate needle supplied in the dose pack for gluteal (2-inch needle) or deltoid (1-inch needle) administration. All components are required for administration. Do not substitute any components of the dose pack. To assure that the intended dose of risperidone is delivered, the full contents from the vial must be administered. Administration of partial contents may not deliver the intended dose of risperidone.

Remove the dose pack of RISPERDAL[®] CONSTA[®] from the refrigerator and allow it to come to room temperature prior to reconstitution.

1. Flip off the plastic colored cap from the vial.

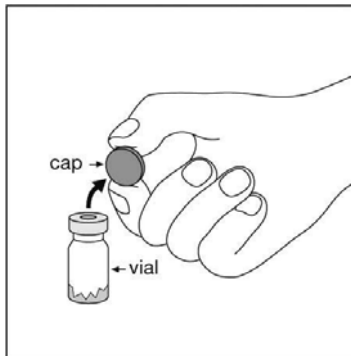

2. Peel back the blister pouch and remove the SmartSite[®] Needle-Free Vial Access Device by holding the white luer cap. Do not touch the spike tip of the access device at any time.

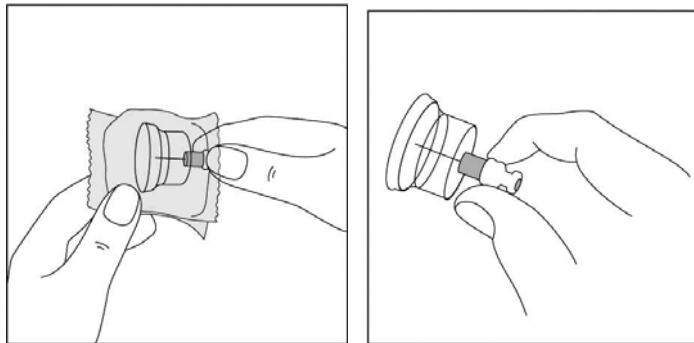

3. Place vial on a hard surface. Hold the base of the vial. Orient the SmartSite[®] Access Device vertically over the vial so that the spike tip is at the center of the vial's rubber stopper. With a straight downward push, press the spike tip of the SmartSite[®] Access Device through the center of the vial's rubber stopper until the device securely snaps onto the vial top.

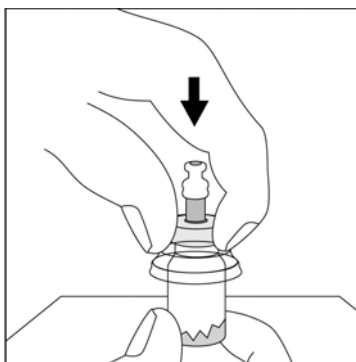

- Swab the syringe connection point (blue circle) of the SmartSite[®] Access Device with preferred antiseptic prior to attaching the syringe to the SmartSite[®] Access Device.



- The prefilled syringe has a white cap consisting of 2 parts: a knurled collar and a smooth cap. To open the syringe, hold the syringe by the knurled collar and **snap** off the smooth cap (**DO NOT TWIST OFF THE CAP**). Remove the white cap together with the rubber tip cap inside.



For all syringe assembly steps, hold the syringe only by the white collar, located at the tip of the syringe. Be careful to not overtighten components when assembling. Overtightening connections may cause syringe component parts to loosen from the syringe body.

- While holding the **white collar** of the syringe, **press** the syringe tip into the blue circle of the SmartSite[®] Access Device and **twist** in a clockwise motion to attach the syringe to the SmartSite[®] Access Device. Hold the skirt of the SmartSite[®] Access Device during attachment to prevent it from spinning. Keep the syringe and SmartSite[®] Access Device aligned.

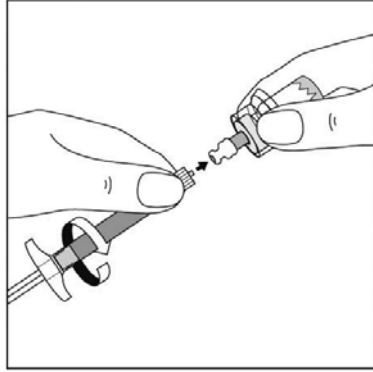

7. Inject the entire contents of the syringe containing the diluent into the vial.

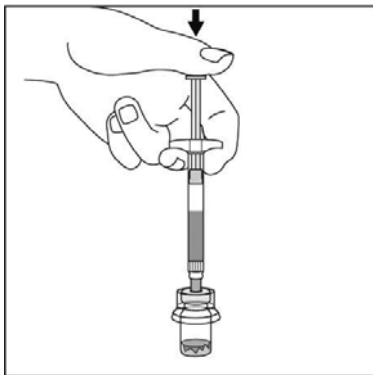

8. Shake the vial vigorously while holding the plunger rod down with the thumb for a minimum of 10 seconds to ensure a homogeneous suspension. When properly mixed, the suspension appears uniform, thick, and milky in color. The particles will be visible in liquid, but no dry particles remain.

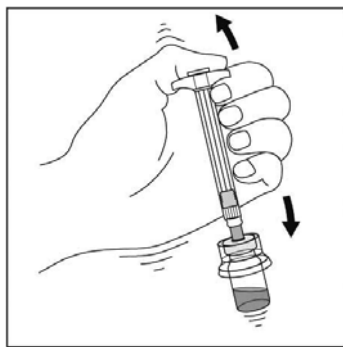

9. Do not store the vial after reconstitution or the suspension may settle. *If 2 minutes pass before injection, re-suspend by shaking vigorously.*

- Invert the vial completely and slowly withdraw the suspension from the vial into the syringe. Tear section of the vial label at the perforation and apply detached label to syringe for identification purposes.

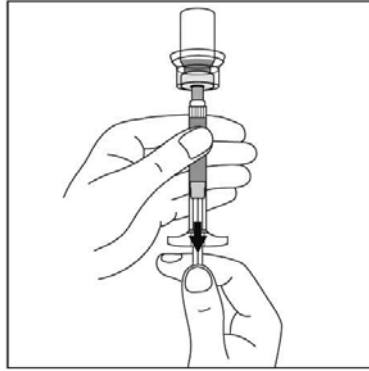

- While holding the **white collar** of the syringe, unscrew the syringe from the SmartSite[®] Access Device. Discard both the vial and access device appropriately.

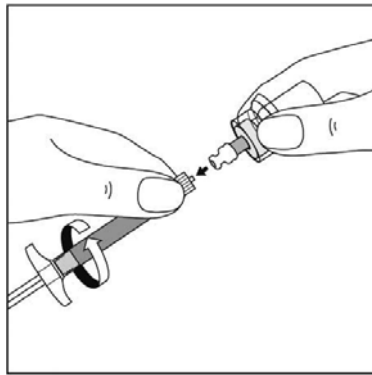

- Select the appropriate needle:

For GLUTEAL injection, select the **20G TW 2-inch** needle (longer needle with **yellow** colored hub in blister with **yellow** print)

For DELTOID injection, select the **21G UTW 1-inch** needle (shorter needle with **green** colored hub in blister with **green** print)

- Peel the blister pouch of the Needle-Pro[®] device open halfway. Grasp sheath using the plastic peel pouch. While holding the **white collar** of the syringe, attach the leuc connection of the Needle-Pro[®] device to the syringe with an easy clockwise twisting motion.

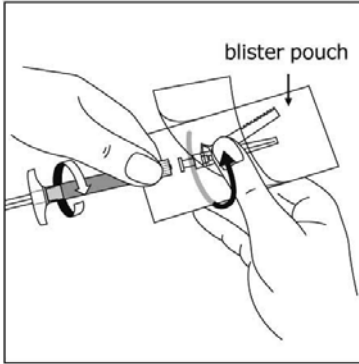

14. If 2 minutes pass before injection, re-suspend by shaking vigorously.

15. While holding the **white collar** of the syringe, pull the sheath away from the needle- do not twist the sheath because it could result in loosening the needle.

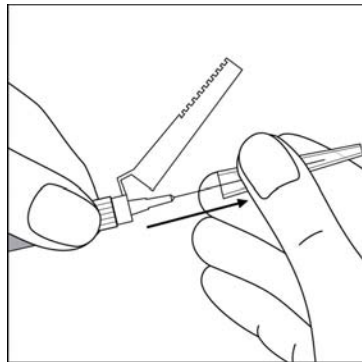

16. Tap the syringe gently to make any air bubbles rise to the top. De-aerate syringe by moving plunger rod carefully forward, with the needle in an upright position. Inject the entire contents of the syringe intramuscularly (IM) into the selected gluteal or deltoid muscle of the patient within 2 minutes to avoid settling. Gluteal injection should be made into the upper-outer quadrant of the gluteal area. **DO NOT ADMINISTER INTRAVENOUSLY.**

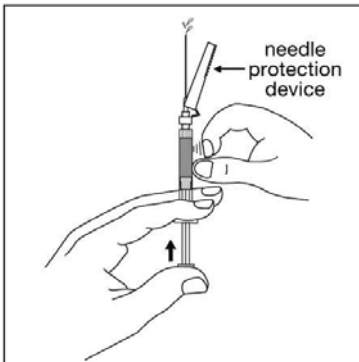

WARNING: To avoid a needle stick injury with a contaminated needle, do not:

- intentionally disengage the Needle-Pro[®] device
 - attempt to straighten the needle or engage Needle-Pro[®] device if the needle is bent or damaged
 - mishandle the needle protection device that could lead to protrusion of the needle from it
17. After injection is complete, use only one hand and tabletop or other hard surface to snap needle into the orange needle protector device before discarding. Discard needle appropriately. Also discard the other (unused) needle.

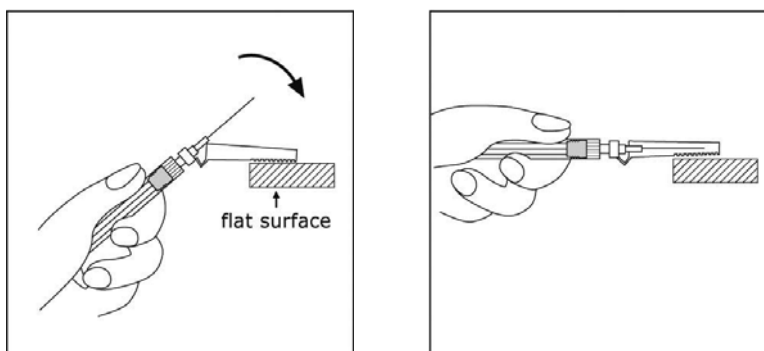

Upon suspension in the diluent, it is recommended to use RISPERDAL[®] CONSTA[®] immediately. RISPERDAL[®] CONSTA[®] must be used within 6 hours of suspension. Resuspension of RISPERDAL[®] CONSTA[®] will be necessary prior to administration, as settling will occur over time once the product is in suspension. Keeping the vial upright, shake vigorously back and forth for as long as it takes to resuspend the microspheres. Once in suspension, the product should not be exposed to temperatures above 77°F (25°C).

Parenteral drug products should be inspected visually for particulate matter and discoloration prior to administration, whenever solution and container permit.

3 DOSAGE FORMS AND STRENGTHS

RISPERDAL[®] CONSTA[®] is available in dosage strengths of 12.5, 25 mg, 37.5 mg, and 50 mg risperidone. It is provided as a dose pack, consisting of a vial containing the risperidone microspheres, a pre-filled syringe containing 2 mL of diluent for RISPERDAL[®] CONSTA[®], a SmartSite[®] Needle-Free Vial Access Device, and two Needle-Pro[®] safety needles for intramuscular injection (a 21 G UTW 1-inch needle with needle protection device for deltoid administration and a 20 G TW needle with needle protection device for gluteal administration).

4 CONTRAINDICATIONS

RISPERDAL[®] CONSTA[®] (risperidone) is contraindicated in patients with a known hypersensitivity to the product.

5 WARNINGS AND PRECAUTIONS

5.1 Increased Mortality in Elderly Patients with Dementia-Related Psychosis

Elderly patients with dementia-related psychosis treated with antipsychotic drugs are at an increased risk of death. RISPERDAL[®] CONSTA[®] (risperidone) is not approved for the treatment of dementia-related psychosis (see Boxed Warning).

5.2 Cerebrovascular Adverse Events, Including Stroke, in Elderly Patients with Dementia-Related Psychosis

Cerebrovascular adverse events (e.g., stroke, transient ischemic attack), including fatalities, were reported in patients (mean age 85 years; range 73-97) in trials of oral risperidone in elderly patients with dementia-related psychosis. In placebo-controlled trials, there was a significantly higher incidence of cerebrovascular adverse events in patients treated with oral risperidone compared to patients treated with placebo. RISPERDAL[®] CONSTA[®] is not approved for the treatment of patients with dementia-related psychosis [See also Boxed Warning and Warnings and Precautions (5.1)]

5.3 Neuroleptic Malignant Syndrome (NMS)

A potentially fatal symptom complex sometimes referred to as Neuroleptic Malignant Syndrome (NMS) has been reported in association with antipsychotic drugs. Clinical manifestations of NMS are hyperpyrexia, muscle rigidity, altered mental status, and evidence of autonomic instability (irregular pulse or blood pressure, tachycardia, diaphoresis, and cardiac dysrhythmia). Additional signs may include elevated creatine phosphokinase, myoglobinuria (rhabdomyolysis), and acute renal failure.

The diagnostic evaluation of patients with this syndrome is complicated. In arriving at a diagnosis, it is important to identify cases in which the clinical presentation includes both serious medical illness (e.g., pneumonia, systemic infection, etc.) and untreated or inadequately treated extrapyramidal signs and symptoms (EPS). Other important considerations in the differential diagnosis include central anticholinergic toxicity, heat stroke, drug fever, and primary central nervous system pathology.

The management of NMS should include: (1) immediate discontinuation of antipsychotic drugs and other drugs not essential to concurrent therapy; (2) intensive symptomatic treatment and medical monitoring; and (3) treatment of any concomitant serious medical

problems for which specific treatments are available. There is no general agreement about specific pharmacological treatment regimens for uncomplicated NMS.

If a patient requires antipsychotic drug treatment after recovery from NMS, the potential reintroduction of drug therapy should be carefully considered. The patient should be carefully monitored, since recurrences of NMS have been reported.

5.4 Tardive Dyskinesia

A syndrome of potentially irreversible, involuntary, dyskinetic movements may develop in patients treated with antipsychotic drugs. Although the prevalence of the syndrome appears to be highest among the elderly, especially elderly women, it is impossible to rely upon prevalence estimates to predict, at the inception of antipsychotic treatment, which patients are likely to develop the syndrome. Whether antipsychotic drug products differ in their potential to cause tardive dyskinesia is unknown.

The risk of developing tardive dyskinesia and the likelihood that it will become irreversible are believed to increase as the duration of treatment and the total cumulative dose of antipsychotic drugs administered to the patient increase. However, the syndrome can develop, although much less commonly, after relatively brief treatment periods at low doses.

There is no known treatment for established cases of tardive dyskinesia, although the syndrome may remit, partially or completely, if antipsychotic treatment is withdrawn. Antipsychotic treatment, itself, however, may suppress (or partially suppress) the signs and symptoms of the syndrome and thereby may possibly mask the underlying process. The effect that symptomatic suppression has upon the long-term course of the syndrome is unknown.

Given these considerations, RISPERDAL[®] CONSTA[®] should be prescribed in a manner that is most likely to minimize the occurrence of tardive dyskinesia. Chronic antipsychotic treatment should generally be reserved for patients who suffer from a chronic illness that: (1) is known to respond to antipsychotic drugs, and (2) for whom alternative, equally effective, but potentially less harmful treatments are not available or appropriate. In patients who do require chronic treatment, the smallest dose and the shortest duration of treatment producing a satisfactory clinical response should be sought. The need for continued treatment should be reassessed periodically.

If signs and symptoms of tardive dyskinesia appear in a patient treated with RISPERDAL[®] CONSTA[®], drug discontinuation should be considered. However, some patients may require treatment with RISPERDAL[®] CONSTA[®] despite the presence of the syndrome.

5.5 Hyperglycemia and Diabetes Mellitus

Hyperglycemia, in some cases extreme and associated with ketoacidosis or hyperosmolar coma or death, has been reported in patients treated with atypical antipsychotics including RISPERDAL[®]. Assessment of the relationship between atypical antipsychotic use and glucose abnormalities is complicated by the possibility of an increased background risk of diabetes mellitus in patients with schizophrenia and the increasing incidence of diabetes mellitus in the general population. Given these confounders, the relationship between atypical antipsychotic use and hyperglycemia-related adverse events is not completely understood. However, epidemiological studies suggest an increased risk of treatment-emergent hyperglycemia-related adverse events in patients treated with the atypical antipsychotics. Precise risk estimates for hyperglycemia-related adverse events in patients treated with atypical antipsychotics are not available.

Patients with an established diagnosis of diabetes mellitus who are started on atypical antipsychotics should be monitored regularly for worsening of glucose control. Patients with risk factors for diabetes mellitus (e.g., obesity, family history of diabetes) who are starting treatment with atypical antipsychotics should undergo fasting blood glucose testing at the beginning of treatment and periodically during treatment. Any patient treated with atypical antipsychotics should be monitored for symptoms of hyperglycemia including polydipsia, polyuria, polyphagia, and weakness. Patients who develop symptoms of hyperglycemia during treatment with atypical antipsychotics should undergo fasting blood glucose testing. In some cases, hyperglycemia has resolved when the atypical antipsychotic was discontinued; however, some patients required continuation of anti-diabetic treatment despite discontinuation of the suspect drug.

5.6 Hyperprolactinemia

As with other drugs that antagonize dopamine D₂ receptors, risperidone elevates prolactin levels and the elevation persists during chronic administration. Risperidone is associated with higher levels of prolactin elevation than other antipsychotic agents.

Hyperprolactinemia may suppress hypothalamic GnRH, resulting in reduced pituitary gonadotropin secretion. This, in turn, may inhibit reproductive function by impairing gonadal steroidogenesis in both female and male patients. Galactorrhea, amenorrhea, gynecomastia, and impotence have been reported in patients receiving prolactin-elevating compounds. Long-standing hyperprolactinemia when associated with hypogonadism may lead to decreased bone density in both female and male subjects.

Tissue culture experiments indicate that approximately one-third of human breast cancers are prolactin dependent *in vitro*, a factor of potential importance if the prescription of these

drugs is contemplated in a patient with previously detected breast cancer. An increase in pituitary gland, mammary gland, and pancreatic islet cell neoplasia (mammary adenocarcinomas, pituitary and pancreatic adenomas) was observed in the risperidone carcinogenicity studies conducted in mice and rats [see *Nonclinical Toxicology (13.1)*]. Neither clinical studies nor epidemiologic studies conducted to date have shown an association between chronic administration of this class of drugs and tumorigenesis in humans; the available evidence is considered too limited to be conclusive at this time.

5.7 Orthostatic Hypotension

RISPERDAL[®] CONSTA[®] may induce orthostatic hypotension associated with dizziness, tachycardia, and in some patients, syncope, especially during the initial dose-titration period with oral risperidone, probably reflecting its alpha-adrenergic antagonistic properties. Syncope was reported in 0.8% (12/1499 patients) of patients treated with RISPERDAL[®] CONSTA[®] in multiple-dose studies. Patients should be instructed in nonpharmacologic interventions that help to reduce the occurrence of orthostatic hypotension (e.g., sitting on the edge of the bed for several minutes before attempting to stand in the morning and slowly rising from a seated position).

RISPERDAL[®] CONSTA[®] should be used with particular caution in (1) patients with known cardiovascular disease (history of myocardial infarction or ischemia, heart failure, or conduction abnormalities), cerebrovascular disease, and conditions which would predispose patients to hypotension, e.g., dehydration and hypovolemia, and (2) in the elderly and patients with renal or hepatic impairment. Monitoring of orthostatic vital signs should be considered in all such patients, and a dose reduction should be considered if hypotension occurs. Clinically significant hypotension has been observed with concomitant use of oral RISPERDAL[®] and antihypertensive medication.

5.8 Potential for Cognitive and Motor Impairment

Somnolence was reported by 5% of patients treated with RISPERDAL[®] CONSTA[®] in multiple-dose trials. Since risperidone has the potential to impair judgment, thinking, or motor skills, patients should be cautioned about operating hazardous machinery, including automobiles, until they are reasonably certain that treatment with RISPERDAL[®] CONSTA[®] does not affect them adversely.

5.9 Seizures

During premarketing testing, seizures occurred in 0.3% (5/1499 patients) of patients treated with RISPERDAL[®] CONSTA[®]. Therefore, RISPERDAL[®] CONSTA[®] should be used cautiously in patients with a history of seizures.

5.10 Dysphagia

Esophageal dysmotility and aspiration have been associated with antipsychotic drug use. Aspiration pneumonia is a common cause of morbidity and mortality in patients with advanced Alzheimer's dementia. RISPERDAL[®] CONSTA[®] and other antipsychotic drugs should be used cautiously in patients at risk for aspiration pneumonia. *[See also Boxed Warning and Warnings and Precautions (5.1)]*

5.11 Priapism

Priapism has been reported during postmarketing surveillance *[see Adverse Reactions (6.8)]*. Severe priapism may require surgical intervention.

5.12 Thrombotic Thrombocytopenic Purpura (TTP)

A single case of TTP was reported in a 28 year-old female patient receiving oral RISPERDAL[®] in a large, open premarketing experience (approximately 1300 patients). She experienced jaundice, fever, and bruising, but eventually recovered after receiving plasmapheresis. The relationship to RISPERDAL[®] therapy is unknown.

5.13 Body Temperature Regulation

Disruption of body temperature regulation has been attributed to antipsychotic agents. Both hyperthermia and hypothermia have been reported in association with oral RISPERDAL[®] or RISPERDAL[®] CONSTA[®] use. Caution is advised when prescribing RISPERDAL[®] CONSTA[®] for patients who will be exposed to temperature extremes.

5.14 Administration

RISPERDAL[®] CONSTA[®] should be injected into the deltoid or gluteal muscle, and care must be taken to avoid inadvertent injection into a blood vessel. *[See Dosage and Administration (2) and Adverse Reactions (6.8)]*

5.15 Antiemetic Effect

Risperidone has an antiemetic effect in animals; this effect may also occur in humans, and may mask signs and symptoms of overdose with certain drugs or of conditions such as intestinal obstruction, Reye's syndrome, and brain tumor.

5.16 Suicide

The possibility of a suicide attempt is inherent in schizophrenia, and close supervision of high-risk patients should accompany drug therapy. RISPERDAL[®] CONSTA[®] is to be administered by a health care professional *[see Dosage and Administration (2)]*; therefore, suicide due to an overdose is unlikely.

5.17 Use in Patients with Concomitant Illness

Clinical experience with RISPERDAL[®] CONSTA[®] in patients with certain concomitant systemic illnesses is limited. Patients with Parkinson's Disease or Dementia with Lewy Bodies who receive antipsychotics, including RISPERDAL[®] CONSTA[®], are reported to have an increased sensitivity to antipsychotic medications. Manifestations of this increased sensitivity have been reported to include confusion, obtundation, postural instability with frequent falls, extrapyramidal symptoms, and clinical features consistent with the neuroleptic malignant syndrome.

Caution is advisable when using RISPERDAL[®] CONSTA[®] in patients with diseases or conditions that could affect metabolism or hemodynamic responses. RISPERDAL[®] CONSTA[®] has not been evaluated or used to any appreciable extent in patients with a recent history of myocardial infarction or unstable heart disease. Patients with these diagnoses were excluded from clinical studies during the product's premarket testing.

Increased plasma concentrations of risperidone and 9-hydroxyrisperidone occur in patients with severe renal impairment (creatinine clearance <30 mL/min/1.73 m²) treated with oral RISPERDAL[®]; an increase in the free fraction of risperidone is also seen in patients with severe hepatic impairment. Patients with renal or hepatic impairment should be carefully titrated on oral RISPERDAL[®] before treatment with RISPERDAL[®] CONSTA[®] is initiated at a dose of 25 mg. A lower initial dose of 12.5 mg may be appropriate when clinical factors warrant dose adjustment, such as in patients with renal or hepatic impairment [*see Dosage and Administration (2.1)*].

5.18 Osteodystrophy and Tumors in Animals

RISPERDAL[®] CONSTA[®] produced osteodystrophy in male and female rats in a 1-year toxicity study and a 2-year carcinogenicity study at a dose of 40 mg/kg administered IM every 2 weeks.

RISPERDAL[®] CONSTA[®] produced renal tubular tumors (adenoma, adenocarcinoma) and adrenomedullary pheochromocytomas in male rats in the 2-year carcinogenicity study at 40 mg/kg administered IM every 2 weeks. In addition, RISPERDAL[®] CONSTA[®] produced an increase in a marker of cellular proliferation in renal tissue in males in the 1-year toxicity study and in renal tumor-bearing males in the 2-year carcinogenicity study at 40 mg/kg administered IM every 2 weeks. (Cellular proliferation was not measured at the low dose or in females in either study.)

The effect dose for osteodystrophy and the tumor findings is 8 times the IM maximum recommended human dose (MRHD) (50 mg) on a mg/m² basis and is associated with a plasma exposure (AUC) 2 times the expected plasma exposure (AUC) at the IM MRHD. The no-effect dose for these findings was 5 mg/kg (equal to the IM MRHD on a mg/m² basis). Plasma exposure (AUC) at the no-effect dose was one third the expected plasma exposure (AUC) at the IM MRHD.

Neither the renal or adrenal tumors, nor osteodystrophy, were seen in studies of orally administered risperidone. Osteodystrophy was not observed in dogs at doses up to 14 times (based on AUC) the IM MRHD in a 1-year toxicity study.

The renal tubular and adrenomedullary tumors in male rats and other tumor findings are described in more detail in Section 13.1 (Carcinogenicity, Mutagenesis, Impairment of Fertility).

The relevance of these findings to human risk is unknown.

5.19 Monitoring: Laboratory Tests

No specific laboratory tests are recommended.

6 ADVERSE REACTIONS

The following are discussed in more detail in other sections of the labeling:

- Increased mortality in elderly patients with dementia-related psychosis [*see Boxed Warning and Warnings and Precautions (5.1)*]
- Cerebrovascular adverse events, including stroke, in elderly patients with dementia-related psychosis [*see Warnings and Precautions (5.2)*]
- Neuroleptic malignant syndrome [*see Warnings and Precautions (5.3)*]
- Tardive dyskinesia [*see Warnings and Precautions (5.4)*]
- Hyperglycemia and diabetes mellitus [*see Warnings and Precautions (5.5)*]
- Hyperprolactinemia [*see Warnings and Precautions (5.6)*]
- Orthostatic hypotension [*see Warnings and Precautions (5.7)*]
- Potential for cognitive and motor impairment [*see Warnings and Precautions (5.8)*]
- Seizures [*see Warnings and Precautions (5.9)*]
- Dysphagia [*see Warnings and Precautions (5.10)*]
- Priapism [*see Warnings and Precautions (5.11)*]

- Thrombotic Thrombocytopenic Purpura (TTP) [*see Warnings and Precautions (5.12)*]
- Disruption of body temperature regulation [*see Warnings and Precautions (5.13)*]
- Avoidance of inadvertent injection into a blood vessel [*see Warnings and Precautions (5.14)*]
- Antiemetic effect [*see Warnings and Precautions (5.15)*]
- Suicide [*see Warnings and Precautions (5.16)*]
- Increased sensitivity in patients with Parkinson's disease or those with dementia with Lewy bodies [*see Warnings and Precautions (5.17)*]
- Diseases or conditions that could affect metabolism or hemodynamic responses [*see Warnings and Precautions (5.17)*]
- Osteodystrophy and tumors in animals [*see Warnings and Precautions (5.18)*]

The most common adverse reactions in clinical trials ($\geq 5\%$) were: headache, parkinsonism, dizziness, akathisia, fatigue, constipation, dyspepsia, sedation, weight increased, pain in extremity, and dry mouth.

The most common adverse reactions that were associated with discontinuation from the 12-week double-blind, placebo-controlled (causing discontinuation in $\geq 1\%$ of patients) were agitation, depression, anxiety, and akathisia [*see Adverse Reactions (6.3)*].

The data described in this section are derived from a clinical trial database consisting of 2392 patients exposed to one or more doses of RISPERDAL[®] CONSTA[®] for the treatment of schizophrenia. Of these 2392 patients, 332 were patients who received RISPERDAL[®] CONSTA[®] while participating in a 12-week double-blind, placebo-controlled trial. Two hundred two (202) of the 332 were schizophrenia patients who received 25 mg or 50 mg RISPERDAL[®] CONSTA[®]. The conditions and duration of treatment with RISPERDAL[®] CONSTA[®] varied greatly and included (in overlapping categories) double-blind, fixed- and flexible-dose, placebo- or active-controlled studies and open-label phases of studies, inpatients and outpatients, and short-term (up to 12 weeks) and longer-term (up to 4 years) exposures. Safety was assessed by collecting adverse events and performing physical examinations, vital signs, body weights, laboratory analyses, and ECGs.

Adverse events during exposure to study treatment were obtained by general inquiry and recorded by clinical investigators using their own terminology. Consequently, to provide a meaningful estimate of the proportion of individuals experiencing adverse events, events were grouped in standardized categories using MedDRA terminology.

Throughout this section, adverse reactions are reported. Adverse reactions are adverse events that were considered to be reasonably associated with the use of RISPERDAL[®] CONSTA[®] (adverse drug reactions) based on the comprehensive assessment of the available adverse event information. A causal association for RISPERDAL[®] CONSTA[®] often cannot be reliably established in individual cases. Further, because clinical trials are conducted under widely varying conditions, adverse reaction rates observed in the clinical trials of a drug cannot be directly compared to rates in the clinical trials of another drug and may not reflect the rates observed in clinical practice.

The majority of all adverse reactions were mild to moderate in severity.

6.1 Commonly-Observed Adverse Reactions in Double-Blind, Placebo-Controlled Clinical Trials

Table 1 lists the adverse reactions reported in 2% or more of RISPERDAL[®] CONSTA[®]-treated patients with schizophrenia in one 12-week double-blind, placebo-controlled trial.

Table 1. Adverse Reactions in $\geq 2\%$ of RISPERDAL[®] CONSTA[®]-Treated Patients with Schizophrenia in a 12-Week Double-Blind, Placebo-Controlled Trial

System Organ Class Adverse Reaction	Percentage of Patients Reporting Event		
	RISPERDAL [®] 25 mg (N=99)	CONSTA [®] 50 mg (N=103)	Placebo (N=98)
Eye disorders			
Vision blurred	2	3	0
Gastrointestinal disorders			
Constipation	5	7	1
Dry mouth	0	7	1
Dyspepsia	6	6	0
Nausea	3	4	5
Toothache	1	3	0
Salivary hypersecretion	4	1	0
General disorders and administration site conditions			
Fatigue*	3	9	0
Edema peripheral	2	3	1
Pain	4	1	0
Pyrexia	2	1	0
Infections and infestations			
Upper respiratory tract infection	2	0	1
Investigations			
Weight increased	5	4	2
Weight decreased	4	1	1
Musculoskeletal and connective tissue disorders			
Pain in extremity	6	2	1
Nervous system disorders			
Headache	15	21	12
Parkinsonism*	8	15	9
Dizziness	7	11	6
Akathisia*	4	11	6
Sedation*	5	6	3
Tremor	0	3	0
Syncope	2	1	0
Hypoesthesia	2	0	0
Respiratory, thoracic and mediastinal disorders			
Cough	4	2	3
Sinus congestion	2	0	0
Skin and subcutaneous tissue disorders			
Acne	2	2	0
Dry skin	2	0	0

* Fatigue includes fatigue and asthenia. Parkinsonism includes extrapyramidal disorder, musculoskeletal stiffness, muscle rigidity, and bradykinesia. Akathisia includes akathisia and restlessness. Sedation includes sedation and somnolence.

6.2 Other Adverse Reactions Observed During the Premarketing Evaluation of RISPERDAL[®] CONSTA[®]

The following adverse reactions occurred in < 2% of the patients in the above 12-week double-blind, placebo-controlled trial. In addition, the following also includes adverse reactions reported in RISPERDAL[®] CONSTA[®]-treated patients who participated in other studies, including double-blind, active-controlled and open-label studies in schizophrenia.

Blood and lymphatic system disorders: anemia, neutropenia

Cardiac disorders: tachycardia, atrioventricular block first degree, palpitations, sinus bradycardia, bundle branch block left, bradycardia, sinus tachycardia, bundle branch block right

Ear and labyrinth disorders: ear pain, vertigo

Endocrine disorders: hyperprolactinemia

Eye disorders: conjunctivitis

Gastrointestinal disorders: diarrhea, vomiting, abdominal pain, stomach discomfort, gastritis

General disorders and administration site conditions: injection site pain, chest discomfort, chest pain, influenza like illness, sluggishness, malaise, induration, injection site induration, injection site reaction

Immune system disorders: hypersensitivity

Infections and infestations: nasopharyngitis, influenza, bronchitis, urinary tract infection, rhinitis, ear infection, pneumonia, lower respiratory tract infection, pharyngitis, sinusitis, viral infection, infection, localized infection, cystitis, gastroenteritis, subcutaneous abscess

Injury and poisoning: fall, procedural pain

Investigations: blood prolactin increased, alanine aminotransferase increased, electrocardiogram abnormal, gamma-glutamyl transferase increased, blood glucose increased, hepatic enzyme increased, aspartate aminotransferase increased

Metabolism and nutritional disorders: increased appetite, decreased appetite

Musculoskeletal, connective tissue and bone disorders: myalgia, back pain, arthralgia, buttock pain, muscular weakness, neck pain, musculoskeletal chest pain

Nervous system disorders: dyskinesia, dystonia, tardive dyskinesia, drooling, paresthesia, dizziness postural, convulsion

Psychiatric disorders: insomnia, agitation, anxiety, sleep disorder, depression, libido decreased, nervousness

Renal and urinary disorders: urinary incontinence

Reproductive system and breast disorders: amenorrhea, erectile dysfunction, galactorrhea, sexual dysfunction, gynecomastia

Respiratory, thoracic and mediastinal disorders: nasal congestion, pharyngolaryngeal pain, dyspnea, rhinorrhea

Skin and subcutaneous tissue disorders: rash, eczema, pruritus

Vascular disorders: hypertension, hypotension, orthostatic hypotension

6.3 Discontinuations Due to Adverse Reactions

Approximately 11% (22/202) of RISPERDAL[®] CONSTA[®]-treated patients in the 12-week double-blind, placebo-controlled trial discontinued treatment due to an adverse event, compared with 13% (13/98) who received placebo. The adverse reactions associated with discontinuation in two or more RISPERDAL[®] CONSTA[®]-treated patients were: agitation (3%), depression (2%), anxiety (1%), and akathisia (1%).

6.4 Dose Dependency of Adverse Reactions in Clinical Trials

Extrapyramidal Symptoms:

Two methods were used to measure extrapyramidal symptoms (EPS) in the 12-week double-blind, placebo-controlled trial comparing three doses of RISPERDAL[®] CONSTA[®] (25 mg, 50 mg, and 75 mg) with placebo, including: (1) the incidence of spontaneous reports of EPS symptoms; and (2) the change from baseline to endpoint on the total score (sum of the subscale scores for Parkinsonism, dystonia, and dyskinesia) of the Extrapyramidal Symptom Rating Scale (ESRS).

As shown in Table 1, the overall incidence of EPS-related adverse reactions (akathisia, dystonia, Parkinsonism, and tremor) in patients treated with 25 mg RISPERDAL[®] CONSTA[®] was comparable to that of patients treated with placebo; the incidence of

EPS-related adverse reactions was higher in patients treated with 50 mg RISPERDAL[®] CONSTA[®].

The median change from baseline to endpoint in total ESRS score showed no worsening in patients treated with RISPERDAL[®] CONSTA[®] compared with patients treated with placebo: 0 (placebo group); -1 (25-mg group, significantly less than the placebo group); and 0 (50-mg group).

Dystonia

Class Effect: Symptoms of dystonia, prolonged abnormal contractions of muscle groups, may occur in susceptible individuals during the first few days of treatment. Dystonic symptoms include: spasm of the neck muscles, sometimes progressing to tightness of the throat, swallowing difficulty, difficulty breathing, and/or protrusion of the tongue. While these symptoms can occur at low doses, they occur more frequently and with greater severity with high potency and at higher doses of first generation antipsychotic drugs. An elevated risk of acute dystonia is observed in males and younger age groups.

6.5 Changes in Body Weight

In the 12-week double-blind, placebo-controlled trial, 9% of patients treated with RISPERDAL[®] CONSTA[®], compared with 6% of patients treated with placebo, experienced a weight gain of >7% of body weight at endpoint.

6.6 Changes in ECG

The electrocardiograms of 202 schizophrenic patients treated with 25 mg or 50 mg RISPERDAL[®] CONSTA[®] and 98 schizophrenic patients treated with placebo in the 12-week double-blind, placebo-controlled trial were evaluated. Compared with placebo, there were no statistically significant differences in QTc intervals (using Fridericia's and linear correction factors) during treatment with RISPERDAL[®] CONSTA[®].

6.7 Pain Assessment and Local Injection Site Reactions

The mean intensity of injection pain reported by patients using a visual analog scale (0 = no pain to 100 = unbearably painful) decreased in all treatment groups from the first to the last injection (placebo: 16.7 to 12.6; 25 mg: 12.0 to 9.0; 50 mg: 18.2 to 11.8). After the sixth injection (Week 10), investigator ratings indicated that 1% of patients treated with 25 mg or 50 mg RISPERDAL[®] CONSTA[®] experienced redness, swelling, or induration at the injection site.

In a separate study to observe local-site tolerability in which RISPERDAL[®] CONSTA[®] was administered into the deltoid muscle every 2 weeks over a period of 8 weeks, no patient

discontinued treatment due to local injection site pain or reaction. Clinician ratings indicated that only mild redness, swelling, or induration at the injection site was observed in subjects treated with 37.5 mg or 50 mg RISPERDAL[®] CONSTA[®] at 2 hours after deltoid injection. All ratings returned to baseline at the predose assessment of the next injection 2 weeks later. No moderate or severe reactions were observed in any subject.

6.8 Postmarketing Experience

The following adverse reactions have been identified during postapproval use of risperidone; because these reactions are reported voluntarily from a population of uncertain size, it is not possible to reliably estimate their frequency: agranulocytosis, alopecia, anaphylactic reaction, angioedema, atrial fibrillation, diabetic ketoacidosis in patients with impaired glucose metabolism, inappropriate antidiuretic hormone secretion, hypothermia, intestinal obstruction, jaundice, mania, pancreatitis, priapism, QT prolongation, sleep apnea syndrome, thrombocytopenia, and water intoxication. In addition, the following adverse reactions have been observed during postapproval use of RISPERDAL[®] CONSTA[®]: cerebrovascular disorders, including cerebrovascular accidents, and diabetes mellitus aggravated.

Retinal artery occlusion after injection of RISPERDAL[®] CONSTA[®] has been reported during postmarketing surveillance. This has been reported in the presence of abnormal arteriovenous anastomosis.

7 DRUG INTERACTIONS

The interactions of RISPERDAL[®] CONSTA[®] with coadministration of other drugs have not been systematically evaluated. The drug interaction data provided in this section is based on studies with oral RISPERDAL[®].

7.1 Centrally-Acting Drugs and Alcohol

Given the primary CNS effects of risperidone, caution should be used when RISPERDAL[®] CONSTA[®] is administered in combination with other centrally-acting drugs or alcohol.

7.2 Drugs with Hypotensive Effects

Because of its potential for inducing hypotension, RISPERDAL[®] CONSTA[®] may enhance the hypotensive effects of other therapeutic agents with this potential.

7.3 Levodopa and Dopamine Agonists

RISPERDAL[®] CONSTA[®] may antagonize the effects of levodopa and dopamine agonists.

7.4 Amitriptyline

Amitriptyline did not affect the pharmacokinetics of risperidone or of risperidone and 9-hydroxyrisperidone combined following concomitant administration with oral RISPERDAL[®].

7.5 Cimetidine and Ranitidine

Cimetidine and ranitidine increased the bioavailability of oral risperidone by 64% and 26%, respectively. However, cimetidine did not affect the AUC of risperidone and 9-hydroxyrisperidone combined, whereas ranitidine increased the AUC of risperidone and 9-hydroxyrisperidone combined by 20%.

7.6 Clozapine

Chronic administration of clozapine with risperidone may decrease the clearance of risperidone.

7.7 Lithium

Repeated doses of oral RISPERDAL[®] (3 mg twice daily) did not affect the exposure (AUC) or peak plasma concentrations (C_{max}) of lithium (n=13).

7.8 Valproate

Repeated doses of oral RISPERDAL[®] (4 mg once daily) did not affect the pre-dose or average plasma concentrations and exposure (AUC) of valproate (1000 mg/day in three divided doses) compared to placebo (n=21). However, there was a 20% increase in valproate peak plasma concentration (C_{max}) after concomitant administration of oral RISPERDAL[®].

7.9 Digoxin

Oral RISPERDAL[®] (0.25 mg twice daily) did not show a clinically relevant effect on the pharmacokinetics of digoxin.

7.10 Topiramate

Oral RISPERDAL[®] administered at doses from 1-6 mg/day concomitantly with topiramate 400 mg/day resulted in a 23% decrease in risperidone C_{max} and a 33% decrease in risperidone $AUC_{0-12 \text{ hour}}$ at steady state. Minimal reductions in the exposure to risperidone and 9-hydroxyrisperidone combined, and no change for 9-hydroxyrisperidone were observed. This interaction is unlikely to be of clinical significance. There was no clinically relevant effect of oral RISPERDAL[®] on the pharmacokinetics of topiramate.

7.11 Drugs That Inhibit CYP 2D6 and Other CYP Isozymes

Risperidone is metabolized to 9-hydroxyrisperidone by CYP 2D6, an enzyme that is polymorphic in the population and that can be inhibited by a variety of psychotropic and other

drugs [see *Clinical Pharmacology (12.3)*]. Drug interactions that reduce the metabolism of risperidone to 9-hydroxyrisperidone would increase the plasma concentrations of risperidone and lower the concentrations of 9-hydroxyrisperidone. Analysis of clinical studies involving a modest number of poor metabolizers (n=70 patients) does not suggest that poor and extensive metabolizers have different rates of adverse effects. No comparison of effectiveness in the two groups has been made.

In vitro studies showed that drugs metabolized by other CYP isozymes, including 1A1, 1A2, 2C9, 2C19, and 3A4, are only weak inhibitors of risperidone metabolism.

Fluoxetine and Paroxetine

Fluoxetine (20 mg once daily) and paroxetine (20 mg once daily), CYP 2D6 inhibitors, have been shown to increase the plasma concentration of risperidone 2.5-2.8 fold and 3-9 fold respectively. Fluoxetine did not affect the plasma concentration of 9-hydroxyrisperidone. Paroxetine lowered the concentration of 9-hydroxyrisperidone by about 10%. When either concomitant fluoxetine or paroxetine is initiated or discontinued, the physician should re-evaluate the dose of RISPERDAL[®] CONSTA[®]. When initiation of fluoxetine or paroxetine is considered, patients may be placed on a lower dose of RISPERDAL[®] CONSTA[®] between 2 to 4 weeks before the planned start of fluoxetine or paroxetine therapy to adjust for the expected increase in plasma concentrations of risperidone. When fluoxetine or paroxetine is initiated in patients receiving the recommended dose of 25 mg RISPERDAL[®] CONSTA[®], it is recommended to continue treatment with the 25-mg dose unless clinical judgment necessitates lowering the RISPERDAL[®] CONSTA[®] dose to 12.5 mg or necessitates interruption of RISPERDAL[®] CONSTA[®] treatment. When RISPERDAL[®] CONSTA[®] is initiated in patients already receiving fluoxetine or paroxetine, a starting dose of 12.5 mg can be considered. The efficacy of the 12.5 mg dose has not been investigated in clinical trials. [See also DOSAGE AND ADMINISTRATION (2.5)]. The effects of discontinuation of concomitant fluoxetine or paroxetine therapy on the pharmacokinetics of risperidone and 9-hydroxyrisperidone have not been studied.

Erythromycin

There were no significant interactions between oral RISPERDAL[®] and erythromycin.

7.12 Carbamazepine and Other CYP 3A4 Enzyme Inducers

Carbamazepine co-administration with oral RISPERDAL[®] decreased the steady-state plasma concentrations of risperidone and 9-hydroxyrisperidone by about 50%. Plasma concentrations of carbamazepine did not appear to be affected. Co-administration of other known CYP 3A4 enzyme inducers (e.g., phenytoin, rifampin, and phenobarbital) with

risperidone may cause similar decreases in the combined plasma concentrations of risperidone and 9-hydroxyrisperidone, which could lead to decreased efficacy of RISPERDAL[®] CONSTA[®] treatment. At the initiation of therapy with carbamazepine or other known hepatic enzyme inducers, patients should be closely monitored during the first 4-8 weeks, since the dose of RISPERDAL[®] CONSTA[®] may need to be adjusted. A dose increase, or additional oral RISPERDAL[®], may need to be considered. On discontinuation of carbamazepine or other CYP 3A4 hepatic enzyme inducers, the dosage of RISPERDAL[®] CONSTA[®] should be re-evaluated and, if necessary, decreased. Patients may be placed on a lower dose of RISPERDAL[®] CONSTA[®] between 2 to 4 weeks before the planned discontinuation of carbamazepine or other CYP 3A4 enzyme inducers to adjust for the expected increase in plasma concentrations of risperidone plus 9-hydroxyrisperidone. For patients treated with the recommended dose of 25 mg RISPERDAL[®] CONSTA[®] and discontinuing from carbamazepine or other CYP 3A4 enzyme inducers, it is recommended to continue treatment with the 25-mg dose unless clinical judgment necessitates lowering the RISPERDAL[®] CONSTA[®] dose to 12.5 mg or necessitates interruption of RISPERDAL[®] CONSTA[®] treatment. The efficacy of the 12.5 mg dose has not been investigated in clinical trials. [See also *DOSAGE AND ADMINISTRATION (2.5)*]

7.13 Drugs Metabolized by CYP 2D6

In vitro studies indicate that risperidone is a relatively weak inhibitor of CYP 2D6. Therefore, RISPERDAL[®] CONSTA[®] is not expected to substantially inhibit the clearance of drugs that are metabolized by this enzymatic pathway. In drug interaction studies, oral RISPERDAL[®] did not significantly affect the pharmacokinetics of donepezil and galantamine, which are metabolized by CYP 2D6.

8 USE IN SPECIFIC POPULATIONS

8.1 Pregnancy

Pregnancy Category C.

The teratogenic potential of oral risperidone was studied in three embryofetal development studies in Sprague-Dawley and Wistar rats (0.63-10 mg/kg or 0.4 to 6 times the oral maximum recommended human dose [MRHD] on a mg/m² basis) and in one embryofetal development study in New Zealand rabbits (0.31-5 mg/kg or 0.4 to 6 times the oral MRHD on a mg/m² basis). The incidence of malformations was not increased compared to control in offspring of rats or rabbits given 0.4 to 6 times the oral MRHD on a mg/m² basis. In three reproductive studies in rats (two peri/post-natal development studies and a multigenerational study), there was an increase in pup deaths during the first 4 days of lactation at doses of

0.16-5 mg/kg or 0.1 to 3 times the oral MRHD on a mg/m² basis. It is not known whether these deaths were due to a direct effect on the fetuses or pups or to effects on the dams.

There was no no-effect dose for increased rat pup mortality. In one peri/post-natal development study, there was an increase in stillborn rat pups at a dose of 2.5 mg/kg or 1.5 times the oral MRHD on a mg/m² basis. In a cross-fostering study in Wistar rats, toxic effects on the fetus or pups, as evidenced by a decrease in the number of live pups and an increase in the number of dead pups at birth (Day 0), and a decrease in birth weight in pups of drug-treated dams were observed. In addition, there was an increase in deaths by Day 1 among pups of drug-treated dams, regardless of whether or not the pups were cross-fostered. Risperidone also appeared to impair maternal behavior in that pup body weight gain and survival (from Days 1 to 4 of lactation) were reduced in pups born to control but reared by drug-treated dams. These effects were all noted at the one dose of risperidone tested, i.e., 5 mg/kg or 3 times the oral MRHD on a mg/m² basis.

No studies were conducted with RISPERDAL[®] CONSTA[®].

Placental transfer of risperidone occurs in rat pups. There are no adequate and well-controlled studies in pregnant women. However, there was one report of a case of agenesis of the corpus callosum in an infant exposed to risperidone *in utero*. The causal relationship to oral RISPERDAL[®] therapy is unknown. Reversible extrapyramidal symptoms in the neonate were observed following postmarketing use of risperidone during the last trimester of pregnancy.

RISPERDAL[®] CONSTA[®] should be used during pregnancy only if the potential benefit justifies the potential risk to the fetus.

8.2 Labor and Delivery

The effect of RISPERDAL[®] CONSTA[®] on labor and delivery in humans is unknown.

8.3 Nursing Mothers

Risperidone and 9-hydroxyrisperidone are also excreted in human breast milk. Therefore, women should not breast-feed during treatment with RISPERDAL[®] CONSTA[®] and for at least 12 weeks after the last injection.

8.4 Pediatric Use

RISPERDAL[®] CONSTA[®] has not been studied in children younger than 18 years old.

8.5 Geriatric Use

In an open-label study, 57 clinically stable, elderly patients (≥65 years old) with schizophrenia or schizoaffective disorder received RISPERDAL[®] CONSTA[®] every 2 weeks for up to 12 months. In general, no differences in the tolerability of RISPERDAL[®] CONSTA[®] were observed between otherwise healthy elderly and nonelderly patients. Therefore, dosing recommendations for otherwise healthy elderly patients are the same as for nonelderly patients. Because elderly patients exhibit a greater tendency to orthostatic hypotension than nonelderly patients, elderly patients should be instructed in nonpharmacologic interventions that help to reduce the occurrence of orthostatic hypotension (e.g., sitting on the edge of the bed for several minutes before attempting to stand in the morning and slowly rising from a seated position). In addition, monitoring of orthostatic vital signs should be considered in elderly patients for whom orthostatic hypotension is of concern [*see Warnings and Precautions (5.8)*].

Concomitant use with Furosemide in Elderly Patients with Dementia-Related Psychosis

In two of four placebo-controlled trials in elderly patients with dementia-related psychosis, a higher incidence of mortality was observed in patients treated with furosemide plus oral risperidone when compared to patients treated with oral risperidone alone or with oral placebo plus furosemide. No pathological mechanism has been identified to explain this finding, and no consistent pattern for cause of death was observed. An increase of mortality in elderly patients with dementia-related psychosis was seen with the use of oral risperidone regardless of concomitant use with furosemide. RISPERDAL[®] CONSTA[®] is not approved for the treatment of patients with dementia-related psychosis. [*See Boxed Warning and Warnings and Precautions (5.1)*]

9 DRUG ABUSE AND DEPENDENCE

9.1 Controlled Substance

RISPERDAL[®] CONSTA[®] (risperidone) is not a controlled substance.

9.2 Abuse

RISPERDAL[®] CONSTA[®] has not been systematically studied in animals or humans for its potential for abuse. Because RISPERDAL[®] CONSTA[®] is to be administered by health care professionals, the potential for misuse or abuse by patients is low.

9.3 Dependence

RISPERDAL[®] CONSTA[®] has not been systematically studied in animals or humans for its potential for tolerance or physical dependence.

10 OVERDOSAGE

10.1 Human Experience

No cases of overdose were reported in premarketing studies with RISPERDAL[®] CONSTA[®]. Because RISPERDAL[®] CONSTA[®] is to be administered by health care professionals, the potential for overdose by patients is low.

In premarketing experience with oral RISPERDAL[®], there were eight reports of acute RISPERDAL[®] overdose, with estimated doses ranging from 20 to 300 mg and no fatalities. In general, reported signs and symptoms were those resulting from an exaggeration of the drug's known pharmacological effects, i.e., drowsiness and sedation, tachycardia and hypotension, and extrapyramidal symptoms. One case, involving an estimated overdose of 240 mg, was associated with hyponatremia, hypokalemia, prolonged QT, and widened QRS. Another case, involving an estimated overdose of 36 mg, was associated with a seizure.

Postmarketing experience with oral RISPERDAL[®] includes reports of acute overdose, with estimated doses of up to 360 mg. In general, the most frequently reported signs and symptoms are those resulting from an exaggeration of the drug's known pharmacological effects, i.e., drowsiness, sedation, tachycardia, hypotension, and extrapyramidal symptoms. Other adverse reactions reported since market introduction related to oral RISPERDAL[®] overdose include prolonged QT interval and convulsions. Torsade de pointes has been reported in association with combined overdose of oral RISPERDAL[®] and paroxetine.

10.2 Management of Overdosage

In case of acute overdosage, establish and maintain an airway and ensure adequate oxygenation and ventilation. Cardiovascular monitoring should commence immediately and should include continuous electrocardiographic monitoring to detect possible arrhythmias. If antiarrhythmic therapy is administered, disopyramide, procainamide, and quinidine carry a theoretical hazard of QT prolonging effects that might be additive to those of risperidone. Similarly, it is reasonable to expect that the alpha-blocking properties of bretylium might be additive to those of risperidone, resulting in problematic hypotension.

There is no specific antidote to risperidone. Therefore, appropriate supportive measures should be instituted. The possibility of multiple drug involvement should be considered. Hypotension and circulatory collapse should be treated with appropriate measures, such as intravenous fluids and/or sympathomimetic agents (epinephrine and dopamine should not be used, since beta stimulation may worsen hypotension in the setting of risperidone-induced alpha blockade). In cases of severe extrapyramidal symptoms, anticholinergic medication

should be administered. Close medical supervision and monitoring should continue until the patient recovers.

11 DESCRIPTION

Risperidone is a psychotropic agent belonging to the chemical class of benzisoxazole derivatives. The chemical designation is 3-[2-[4-(6-fluoro-1,2-benzisoxazol-3-yl)-1-piperidinyl]ethyl]-6,7,8,9-tetrahydro-2-methyl-4H-pyrido[1,2-a]pyrimidin-4-one. Its molecular formula is $C_{23}H_{27}FN_4O_2$ and its molecular weight is 410.49. The structural formula is:

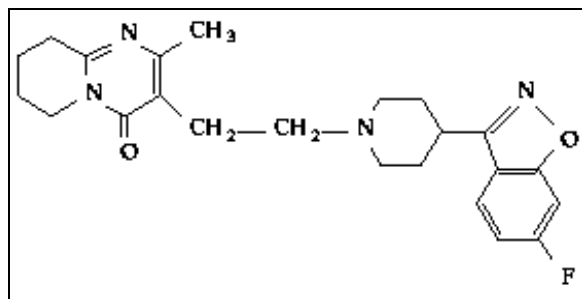

Risperidone is practically insoluble in water, freely soluble in methylene chloride, and soluble in methanol and 0.1 N HCl.

RISPERDAL[®] CONSTA[®] (risperidone) Long-Acting Injection is a combination of extended-release microspheres for injection and diluent for parenteral use.

The extended-release microspheres formulation is a white to off-white, free-flowing powder that is available in dosage strengths of 12.5, 25, 37.5, or 50 mg risperidone per vial. Risperidone is micro-encapsulated in 7525 polylactide-co-glycolide (PLG) at a concentration of 381 mg risperidone per gram of microspheres.

The diluent for parenteral use is a clear, colorless solution. Composition of the diluent includes polysorbate 20, sodium carboxymethyl cellulose, disodium hydrogen phosphate dihydrate, citric acid anhydrous, sodium chloride, sodium hydroxide, and water for injection. The microspheres are suspended in the diluent prior to injection.

RISPERDAL[®] CONSTA[®] is provided as a dose pack, consisting of a vial containing the microspheres, a pre-filled syringe containing the diluent, a SmartSite[®] Needle-Free Vial Access Device, and two Needle-Pro[®] 20 G TW safety needles (a 21 G UTW 1-inch needle with needle protection device for deltoid administration and a 20 G TW 2-inch needle with needle protection device for gluteal administration).

12 CLINICAL PHARMACOLOGY

12.1 Mechanism of Action

The mechanism of action of RISPERDAL[®] CONSTA[®], as with other drugs used to treat schizophrenia, is unknown. However, it has been proposed that the drug's therapeutic activity in schizophrenia is mediated through a combination of dopamine Type 2 (D₂) and serotonin Type 2 (5HT₂) receptor antagonism.

RISPERDAL[®] is a selective monoaminergic antagonist with high affinity (K_i of 0.12 to 7.3 nM) for the serotonin Type 2 (5HT₂), dopamine Type 2 (D₂), α₁ and α₂ adrenergic, and H₁ histaminergic receptors. RISPERDAL[®] acts as an antagonist at other receptors, but with lower potency. RISPERDAL[®] has low to moderate affinity (K_i of 47 to 253 nM) for the serotonin 5HT_{1C}, 5HT_{1D}, and 5HT_{1A} receptors, weak affinity (K_i of 620 to 800 nM) for the dopamine D₁ and haloperidol-sensitive sigma site, and no affinity (when tested at concentrations >10⁻⁵ M) for cholinergic muscarinic or β₁ and β₂ adrenergic receptors.

12.2 Pharmacodynamics

The clinical effect from RISPERDAL[®] CONSTA[®] results from the combined concentrations of risperidone and its major metabolite, 9-hydroxyrisperidone [*see Clinical Pharmacology (12.3)*]. Antagonism at receptors other than D₂ and 5HT₂ [*see Clinical Pharmacology (12.1)*] may explain some of the other effects of RISPERDAL[®] CONSTA[®].

12.3 Pharmacokinetics

Absorption

After a single intramuscular (gluteal) injection of RISPERDAL[®] CONSTA[®], there is a small initial release of the drug (< 1% of the dose), followed by a lag time of 3 weeks. The main release of the drug starts from 3 weeks onward, is maintained from 4 to 6 weeks, and subsides by 7 weeks following the intramuscular (IM) injection. Therefore, oral antipsychotic supplementation should be given during the first 3 weeks of treatment with RISPERDAL[®] CONSTA[®] to maintain therapeutic levels until the main release of risperidone from the injection site has begun [*see Dosage and Administration (2)*]. Following single doses of RISPERDAL[®] CONSTA[®], the pharmacokinetics of risperidone, 9-hydroxyrisperidone (the major metabolite), and risperidone plus 9-hydroxyrisperidone were linear in the dosing range of 12.5 mg to 50 mg.

The combination of the release profile and the dosage regimen (IM injections every 2 weeks) of RISPERDAL[®] CONSTA[®] results in sustained therapeutic concentrations. Steady-state plasma concentrations are reached after 4 injections and are maintained for 4 to 6 weeks after the last injection. Following multiple doses of 25 mg and 50 mg

RISPERDAL[®] CONSTA[®], plasma concentrations of risperidone, 9-hydroxyrisperidone, and risperidone plus 9-hydroxyrisperidone were linear.

Deltoid and gluteal intramuscular injections at the same doses are bioequivalent and, therefore, interchangeable.

Distribution

Once absorbed, risperidone is rapidly distributed. The volume of distribution is 1-2 L/kg. In plasma, risperidone is bound to albumin and α 1-acid glycoprotein. The plasma protein binding of risperidone is approximately 90%, and that of its major metabolite, 9-hydroxyrisperidone, is 77%. Neither risperidone nor 9-hydroxyrisperidone displaces each other from plasma binding sites. High therapeutic concentrations of sulfamethazine (100 mcg/mL), warfarin (10 mcg/mL), and carbamazepine (10 mcg/mL) caused only a slight increase in the free fraction of risperidone at 10 ng/mL and of 9-hydroxyrisperidone at 50 ng/mL, changes of unknown clinical significance.

Metabolism and Drug Interactions

Risperidone is extensively metabolized in the liver. The main metabolic pathway is through hydroxylation of risperidone to 9-hydroxyrisperidone by the enzyme, CYP 2D6. A minor metabolic pathway is through N-dealkylation. The main metabolite, 9-hydroxyrisperidone, has similar pharmacological activity as risperidone. Consequently, the clinical effect of the drug results from the combined concentrations of risperidone plus 9-hydroxyrisperidone.

CYP 2D6, also called debrisoquin hydroxylase, is the enzyme responsible for metabolism of many neuroleptics, antidepressants, antiarrhythmics, and other drugs. CYP 2D6 is subject to genetic polymorphism (about 6%-8% of Caucasians, and a very low percentage of Asians, have little or no activity and are “poor metabolizers”) and to inhibition by a variety of substrates and some non-substrates, notably quinidine. Extensive CYP 2D6 metabolizers convert risperidone rapidly into 9-hydroxyrisperidone, whereas poor CYP 2D6 metabolizers convert it much more slowly. Although extensive metabolizers have lower risperidone and higher 9-hydroxyrisperidone concentrations than poor metabolizers, the pharmacokinetics of risperidone and 9-hydroxyrisperidone combined, after single and multiple doses, are similar in extensive and poor metabolizers.

The interactions of RISPERDAL[®] CONSTA[®] with coadministration of other drugs have not been systematically evaluated in human subjects. Drug interactions are based primarily on experience with oral RISPERDAL[®]. Risperidone could be subject to two kinds of drug-drug interactions. First, inhibitors of CYP 2D6 interfere with conversion of risperidone to 9-hydroxyrisperidone [*see Drug Interactions (7.11)*]. This occurs with quinidine, giving

essentially all recipients a risperidone pharmacokinetic profile typical of poor metabolizers. The therapeutic benefits and adverse effects of RISPERDAL[®] in patients receiving quinidine have not been evaluated, but observations in a modest number (n≅70) of poor metabolizers given oral RISPERDAL[®] do not suggest important differences between poor and extensive metabolizers. Second, co-administration of carbamazepine and other known enzyme inducers (e.g., phenytoin, rifampin, and phenobarbital) with oral RISPERDAL[®] cause a decrease in the combined plasma concentrations of risperidone and 9-hydroxyrisperidone [*see Drug Interactions (7.12)*]. It would also be possible for risperidone to interfere with metabolism of other drugs metabolized by CYP 2D6. Relatively weak binding of risperidone to the enzyme suggests this is unlikely [*see Drug Interactions (7.11)*].

Excretion

Risperidone and its metabolites are eliminated via the urine and, to a much lesser extent, via the feces. As illustrated by a mass balance study of a single 1 mg oral dose of ¹⁴C-risperidone administered as solution to three healthy male volunteers, total recovery of radioactivity at 1 week was 84%, including 70% in the urine and 14% in the feces.

The apparent half-life of risperidone plus 9-hydroxyrisperidone following RISPERDAL[®] CONSTA[®] administration is 3 to 6 days, and is associated with a monoexponential decline in plasma concentrations. This half-life of 3-6 days is related to the erosion of the microspheres and subsequent absorption of risperidone. The clearance of risperidone and risperidone plus 9-hydroxyrisperidone was 13.7 L/h and 5.0 L/h in extensive CYP 2D6 metabolizers, and 3.3 L/h and 3.2 L/h in poor CYP 2D6 metabolizers, respectively. No accumulation of risperidone was observed during long-term use (up to 12 months) in patients treated every 2 weeks with 25 mg or 50 mg RISPERDAL[®] CONSTA[®]. The elimination phase is complete approximately 7 to 8 weeks after the last injection.

Renal Impairment

In patients with moderate to severe renal disease treated with oral RISPERDAL[®], clearance of the sum of risperidone and its active metabolite decreased by 60% compared with young healthy subjects. Although patients with renal impairment were not studied with RISPERDAL[®] CONSTA[®], it is recommended that patients with renal impairment be carefully titrated on oral RISPERDAL[®] before treatment with RISPERDAL[®] CONSTA[®] is initiated at a dose of 25 mg. A lower initial dose of 12.5 mg may be appropriate when clinical factors warrant dose adjustment, such as in patients with renal impairment [*see Dosage and Administration (2.1)*].

Hepatic Impairment

While the pharmacokinetics of oral RISPERDAL[®] in subjects with liver disease were comparable to those in young healthy subjects, the mean free fraction of risperidone in plasma was increased by about 35% because of the diminished concentration of both albumin and α_1 -acid glycoprotein. Although patients with hepatic impairment were not studied with RISPERDAL[®] CONSTA[®], it is recommended that patients with hepatic impairment be carefully titrated on oral RISPERDAL[®] before treatment with RISPERDAL[®] CONSTA[®] is initiated at a dose of 25 mg. A lower initial dose of 12.5 mg may be appropriate when clinical factors warrant dose adjustment, such as in patients with hepatic impairment [see *Dosage and Administration (2.1)*].

Elderly

In an open-label trial, steady-state concentrations of risperidone plus 9-hydroxyrisperidone in otherwise healthy elderly patients (≥ 65 years old) treated with RISPERDAL[®] CONSTA[®] for up to 12 months fell within the range of values observed in otherwise healthy nonelderly patients. Dosing recommendations are the same for otherwise healthy elderly patients and nonelderly patients [see *Dosage and Administration (2)*].

Race and Gender Effects

No specific pharmacokinetic study was conducted to investigate race and gender effects, but a population pharmacokinetic analysis did not identify important differences in the disposition of risperidone due to gender (whether or not corrected for body weight) or race.

13 NONCLINICAL TOXICOLOGY

13.1 Carcinogenesis, Mutagenesis, Impairment of Fertility

Carcinogenesis - Oral

Carcinogenicity studies were conducted in Swiss albino mice and Wistar rats. Risperidone was administered in the diet at doses of 0.63, 2.5, and 10 mg/kg for 18 months to mice and for 25 months to rats. These doses are equivalent to 2.4, 9.4, and 37.5 times the oral maximum recommended human dose (MRHD) for schizophrenia (16 mg/day) on a mg/kg basis, or 0.2, 0.75, and 3 times the oral MRHD (mice) or 0.4, 1.5, and 6 times the oral MRHD (rats) on a mg/m² basis. A maximum tolerated dose was not achieved in male mice. There was a significant increase in pituitary gland adenomas in female mice at doses 0.75 and 3 times the oral MRHD on a mg/m² basis. There was a significant increase in endocrine pancreatic adenomas in male rats at doses 1.5 and 6 times the oral MRHD on a mg/m² basis. Mammary gland adenocarcinomas were significantly increased in female mice at all doses tested (0.2, 0.75, and 3 times the oral MRHD on a mg/m² basis), in female rats at all doses tested

(0.4, 1.5, and 6 times the oral MRHD on a mg/m² basis), and in male rats at a dose 6 times the oral MRHD on a mg/m² basis.

Carcinogenesis - Intramuscular

RISPERDAL[®] CONSTA[®] was evaluated in a 24-month carcinogenicity study in which SPF Wistar rats were treated every 2 weeks with intramuscular (IM) injections of either 5 mg/kg or 40 mg/kg of risperidone. These doses are 1 and 8 times the MRHD (50 mg) on a mg/m² basis. A control group received injections of 0.9% NaCl, and a vehicle control group was injected with placebo microspheres. There was a significant increase in pituitary gland adenomas, endocrine pancreas adenomas, and adrenomedullary pheochromocytomas at 8 times the IM MRHD on a mg/m² basis. The incidence of mammary gland adenocarcinomas was significantly increased in female rats at both doses (1 and 8 times the IM MRHD on a mg/m² basis). A significant increase in renal tubular tumors (adenoma, adenocarcinomas) was observed in male rats at 8 times the IM MRHD on a mg/m² basis. Plasma exposures (AUC) in rats were 0.3 and 2 times (at 5 and 40 mg/kg, respectively) the expected plasma exposure (AUC) at the IM MRHD.

Dopamine D₂ receptor antagonists have been shown to chronically elevate prolactin levels in rodents. Serum prolactin levels were not measured during the carcinogenicity studies of oral risperidone; however, measurements taken during subchronic toxicity studies showed that oral risperidone elevated serum prolactin levels 5- to 6-fold in mice and rats at the same doses used in the oral carcinogenicity studies. Serum prolactin levels increased in a dose-dependent manner up to 6- and 1.5-fold in male and female rats, respectively, at the end of the 24-month treatment with RISPERDAL[®] CONSTA[®] every 2 weeks. Increases in the incidence of pituitary gland, endocrine pancreas, and mammary gland neoplasms have been found in rodents after chronic administration of other antipsychotic drugs and may be prolactin-mediated.

The relevance for human risk of the findings of prolactin-mediated endocrine tumors in rodents is unknown [see *Warnings and Precautions (5.7)*].

Mutagenesis

No evidence of mutagenic potential for oral risperidone was found in the *in vitro* Ames reverse mutation test, *in vitro* mouse lymphoma assay, *in vitro* rat hepatocyte DNA-repair assay, *in vivo* oral micronucleus test in mice, the sex-linked recessive lethal test in *Drosophila*, or the *in vitro* chromosomal aberration test in human lymphocytes or in Chinese hamster cells.

In addition, no evidence of mutagenic potential was found in the *in vitro* Ames reverse mutation test for RISPERDAL[®] CONSTA[®].

Impairment of Fertility

Oral risperidone (0.16 to 5 mg/kg) was shown to impair mating, but not fertility, in Wistar rats in three reproductive studies (two mating and fertility studies and a multigenerational study) at doses 0.1 to 3 times the oral maximum recommended human dose (MRHD) (16 mg/day) on a mg/m² basis. The effect appeared to be in females, since impaired mating behavior was not noted in the mating and fertility study in which males only were treated. In a subchronic study in Beagle dogs in which oral risperidone was administered at doses of 0.31 to 5 mg/kg, sperm motility and concentration were decreased at doses 0.6 to 10 times the oral MRHD on a mg/m² basis. Dose-related decreases were also noted in serum testosterone at the same doses. Serum testosterone and sperm values partially recovered, but remained decreased after treatment was discontinued. No no-effect doses were noted in either rat or dog.

No mating and fertility studies were conducted with RISPERDAL[®] CONSTA[®].

14 CLINICAL STUDIES

The effectiveness of RISPERDAL[®] CONSTA[®] in the treatment of schizophrenia was established, in part, on the basis of extrapolation from the established effectiveness of the oral formulation of risperidone. In addition, the effectiveness of RISPERDAL[®] CONSTA[®] in the treatment of schizophrenia was established in a 12-week, placebo-controlled trial in adult psychotic inpatients and outpatients who met the DSM-IV criteria for schizophrenia.

Efficacy data were obtained from 400 patients with schizophrenia who were randomized to receive injections of 25, 50, or 75 mg RISPERDAL[®] CONSTA[®] or placebo every 2 weeks. During a 1-week run-in period, patients were discontinued from other antipsychotics and were titrated to a dose of 4 mg oral RISPERDAL[®]. Patients who received RISPERDAL[®] CONSTA[®] were given doses of oral RISPERDAL[®] (2 mg for patients in the 25-mg group, 4 mg for patients in the 50-mg group, and 6 mg for patients in the 75-mg group) for the 3 weeks after the first injection to provide therapeutic plasma concentrations until the main release phase of risperidone from the injection site had begun. Patients who received placebo injections were given placebo tablets.

Efficacy was evaluated using the Positive and Negative Syndrome Scale (PANSS), a validated, multi-item inventory, composed of five subscales to evaluate positive symptoms, negative symptoms, disorganized thoughts, uncontrolled hostility/excitement, and anxiety/depression.

The primary efficacy variable in this trial was change from baseline to endpoint in the total PANSS score. The mean total PANSS score at baseline for schizophrenic patients in this study was 81.5.

Total PANSS scores showed significant improvement in the change from baseline to endpoint in schizophrenic patients treated with each dose of RISPERDAL[®] CONSTA[®] (25 mg, 50 mg, or 75 mg) compared with patients treated with placebo. While there were no statistically significant differences between the treatment effects for the three dose groups, the effect size for the 75 mg dose group was actually numerically less than that observed for the 50 mg dose group.

Subgroup analyses did not indicate any differences in treatment outcome as a function of age, race, or gender.

16 HOW SUPPLIED/STORAGE AND HANDLING

RISPERDAL[®] CONSTA[®] (risperidone) is available in dosage strengths of 12.5, 25, 37.5, or 50 mg risperidone. It is provided as a dose pack, consisting of a vial containing the risperidone microspheres, a pre-filled syringe containing 2 mL of diluent for RISPERDAL[®] CONSTA[®], a SmartSite[®] Needle-Free Vial Access Device, and two Needle-Pro[®] safety needles for intramuscular injection (a 21 G UTW 1-inch needle with needle protection device for deltoid administration and a 20 G TW 2-inch needle with needle protection device for gluteal administration).

12.5-mg vial/kit (NDC 50458-309-11): 12.5 mg of a white to off-white powder provided in a vial with a violet flip-off cap (NDC 50458-309-01).

25-mg vial/kit (NDC 50458-306-11): 25 mg of a white to off-white powder provided in a vial with a pink flip-off cap (NDC 50458-306-01).

37.5-mg vial/kit (NDC 50458-307-11): 37.5 mg of a white to off-white powder provided in a vial with a green flip-off cap (NDC 50458-307-01).

50-mg vial/kit (NDC 50458-308-11): 50 mg of a white to off-white powder provided in a vial with a blue flip-off cap (NDC 50458-308-01).

Storage and Handling

The entire dose pack should be stored in the refrigerator (36°- 46°F; 2°- 8°C) and protected from light.

If refrigeration is unavailable, RISPERDAL[®] CONSTA[®] can be stored at temperatures not exceeding 77°F (25°C) for no more than 7 days prior to administration. Do not expose unrefrigerated product to temperatures above 77°F (25°C).

Keep out of reach of children.

17 PATIENT COUNSELING INFORMATION

Physicians are advised to discuss the following issues with patients for whom they prescribe RISPERDAL[®] CONSTA[®].

17.1 Orthostatic Hypotension

Patients should be advised of the risk of orthostatic hypotension and instructed in nonpharmacologic interventions that help to reduce the occurrence of orthostatic hypotension (e.g., sitting on the edge of the bed for several minutes before attempting to stand in the morning and slowly rising from a seated position) [*see Warnings and Precautions (5.8)*].

17.2 Interference with Cognitive and Motor Performance

Because RISPERDAL[®] CONSTA[®] has the potential to impair judgment, thinking, or motor skills, patients should be cautioned about operating hazardous machinery, including automobiles, until they are reasonably certain that treatment with RISPERDAL[®] CONSTA[®] does not affect them adversely [*see Warnings and Precautions (5.9)*].

17.3 Pregnancy

Patients should be advised to notify their physician if they become pregnant or intend to become pregnant during therapy and for at least 12 weeks after the last injection of RISPERDAL[®] CONSTA[®] [*see Use in Specific Populations (8.1)*].

17.4 Nursing

Patients should be advised not to breast-feed an infant during treatment and for at least 12 weeks after the last injection of RISPERDAL[®] CONSTA[®] [*see Use in Specific Populations (8.2)*].

17.5 Concomitant Medication

Patients should be advised to inform their physicians if they are taking, or plan to take, any prescription or over-the-counter drugs, since there is a potential for interactions [*see Drug Interactions (7)*].

17.6 Alcohol

Patients should be advised to avoid alcohol during treatment with RISPERDAL[®] CONSTA[®] [*see Drug Interactions (7.1)*].

[INSERT NEW COMPONENT CODE]

Revised [INSERT MONTH AND YEAR OF FDA APPROVAL]
©Ortho-McNeil-Janssen Pharmaceuticals, Inc. 2007

Risperidone is manufactured by:

Janssen Pharmaceutical Ltd.
Wallingstown, Little Island, County Cork, Ireland

Microspheres are manufactured by:
Alkermes, Inc.
Wilmington, Ohio

Diluent is manufactured by:
Vetter Pharma Fertigung GmbH & Co. KG
Ravensburg or Langenargen, Germany

or

Cilag AG
Schaffhausen, Switzerland

RISPERDAL[®] CONSTA[®] is manufactured for:
Janssen, Division of Ortho-McNeil-Janssen Pharmaceuticals, Inc.
Titusville, NJ 08560