

CENTER FOR DRUG EVALUATION AND RESEARCH

Approval Package for:

APPLICATION NUMBER:

021346Orig1s054

Trade Name: RISPERDAL CONSTA
Generic or Proper Name: (risperidone)

Sponsor: Janssen Pharmaceuticals Inc.

Approval Date: November 18, 2016

Indication: RISPERDAL® CONSTA® is an atypical antipsychotic indicated:

- for the treatment of schizophrenia.
- as monotherapy or as adjunctive therapy to lithium or valproate for the maintenance treatment of Bipolar I Disorder.

CENTER FOR DRUG EVALUATION AND RESEARCH

021346Orig1s054

CONTENTS

Reviews / Information Included in this NDA Review.

Approval Letter	X
Other Action Letters	X
Labeling	X
REMS	
Summary Review	
Officer/Employee List	
Office Director Memo	
Cross Discipline Team Leader Review	
Clinical Review(s)	
Product Quality Review(s)	X
Non-Clinical Review(s)	
Statistical Review(s)	
Clinical Microbiology / Virology Review(s)	
Clinical Pharmacology Review(s)	
Other Reviews	
Risk Assessment and Risk Mitigation Review(s)	
Proprietary Name Review(s)	
Administrative/Correspondence Document(s)	

**CENTER FOR DRUG EVALUATION AND
RESEARCH**

APPLICATION NUMBER:

021346Orig1s054

APPROVAL LETTER



sNDAs: **See Attached List**

APPROVAL LETTER

Janssen Research & Development, LLC
U.S. Agent for: Janssen Pharmaceuticals, Inc.
Attention: Donna L. Herdzik
Manager, CMC Global Regulatory Affairs
1400 Welsh Road
Spring House, PA 19477

Dear Ms. Herdzik:

Please refer to your Supplemental New Drug Application (sNDAs) dated and received October 31, 2014, and your amendments dated September 30, 2015, February 18, 2016, and July 20, 2016, pursuant to section 505(b)(1) of the Federal Food, Drug, and Cosmetic Act (FDCA) for: **See Attached List**.

We acknowledge receipt of your amendment dated July 20, 2016, which constituted a complete response to our June 17, 2016, action letter.

The “Prior Approval” supplemental new drug applications provide for:

- Changes in the risperidone drug substance specification and methods by reference to Drug Master File (DMF) 11438.

We have completed our review of these supplemental new drug applications, as amended, and they are approved.

We remind you that you must comply with the requirements for an approved NDA set forth under 21 CFR 314.80 and 314.81.

If you have any questions, contact Michael S. Azer, Regulatory Business Process Manager, at (240) 402-4638 or michael.azer@fda.hhs.gov.

Sincerely,

{See appended electronic signature page}

David Lewis, Ph.D.
Chief (Acting), Branch II
Division of Post Marketing Activities I
Office of Lifecycle Products
Office of Pharmaceutical Quality

Group Supplement List

NDA #	Supplement #	Product Name	Dosage Form
020272	Supplement-075	Risperdal® (risperidone)	Film Coated Tablets
020588	Supplement-064	Risperdal® (risperidone)	Oral Solution
021444	Supplement-050	Risperdal® (risperidone)	Orally Disintegrating Tablets
021346	Supplement-054	Risperdal® Consta (risperidone)	Long-Acting Injection



David
Lewis

Digitally signed by David Lewis
Date: 11/18/2016 09:11:15AM
GUID: 508da7200029f287fa31e664741b577



**CENTER FOR DRUG EVALUATION AND
RESEARCH**

APPLICATION NUMBER:

021346Orig1s054

OTHER ACTION LETTERS



NDA's 20272/S-075, 20588/S-064, 21444/S-050, 21346/S-054

COMPLETE RESPONSE

Janssen Pharmaceuticals, Inc.
c/o Janssen Research & Development, L.L.C.
Attention: Donna Herdzyk, Manager, CMC Global Regulatory Affairs
1400 Welsh Road
Spring House, PA 19477

Dear Ms. Herdzyk:

Please refer to your supplemental new drug applications (sNDA) submitted under section 505(b) of the Federal Food, Drug, and Cosmetic Act for the following:

NDA	Supplement #	Drug Product	Receipt Date
20272	S-075	Risperdal® (risperidone) Film Coated Tablets	October 31, 2014
20588	S-064	Risperdal® (risperidone) Oral Solution	October 31, 2014
21444	S-050	Risperdal® (risperidone) Orally Disintegrating Tablets	October 31, 2014
21346	S-054	Risperdal® Consta (risperidone) Long-Acting Injection	November 3, 2014

We acknowledge receipt of your amendments dated February 18, 2016 and February 24, 2016, which constituted a complete response to our January 29, 2016, action letter.

These "Prior Approval" supplemental new drug applications notify the Agency of an amendment to DMF 11438 to update the drug substance specifications and methods.

We have completed the review of your applications, and have determined that we cannot approve these applications in its present form. We have described below our reasons for this action and, where possible, our recommendations to address these issues.

Your application referenced the Drug Master File (DMF) 11438. This DMF was found inadequate to support your submission and a deficiency letter was sent to the DMF holder on June 16, 2016. These deficiencies must be adequately addressed before this application can be approved. As part of your response to this letter, include the date the DMF holder amended their DMF to address the deficiencies.

OTHER

Within one year after the date of this letter, you are required to resubmit or take one of the other actions available under 21 CFR 314.110. If you do not take one of these actions, we will consider your lack of response a request to withdraw the application under 21 CFR 314.65. A resubmission must fully address all the deficiencies listed. A partial response to this letter will not be processed as a resubmission and will not start a new review cycle.

Under 21 CFR 314.102(d), you may request a meeting or telephone conference with us to discuss what steps you need to take before the application may be approved. If you wish to have such a meeting, submit your meeting request as described in the FDA's *Guidance for Industry - Formal Meetings Between the FDA and Sponsors or Applicants*, May 2009 at <http://www.fda.gov/downloads/Drugs/GuidanceComplianceRegulatoryInformation/Guidances/UCM153222.pdf>.

These products may be considered to be misbranded under the Federal Food, Drug, and Cosmetic Act if it is marketed with this change before approval of these supplemental applications.

If you have any questions, call Teshara G. Bouie, Regulatory Business Process Manager, at (301) 796-1649.

Sincerely,

Hasmukh B. Patel -S

Digitally signed by Hasmukh B. Patel -S
DN: c=US, o=U.S. Government, ou=HHS, ou=FDA,
ou=People, ou=2342.19200300.100.1.1=1300068254,
cn=Hasmukh B. Patel -S
Date: 2016.06.17 14:55:29 -04'00'

Hasmukh Patel, Ph.D.
Division Director (Acting)
Division of Post Marketing Activities I
Office of Lifecycle Drug Products
Office of Pharmaceutical Quality
Center for Drug Evaluation and Research



NDA 21346/S-054

COMPLETE RESPONSE

Janssen Pharmaceuticals, Inc.
c/o Janssen Research & Development, L.L.C.
Attention: Corrine L. Curtis, Ph.D., Manager, CMC, Global Regulatory Affairs
1400 Welsh Road
Spring House, PA 19477

Dear Dr. Curtis:

Please refer to your supplemental new drug application (sNDA) dated November 3, 2014, received November 3, 2014, submitted under section 505(b) of the Federal Food, Drug, and Cosmetic Act for Risperdal® Consta (risperidone) Long-Acting Injection.

We acknowledge receipt of your amendment dated October 7, 2015, which constituted a complete response to our March 3, 2015, action letter.

This “Prior Approval” supplemental new drug application notifies the Agency of an amendment to DMF 11438 to update the drug substance specifications and methods.

We have completed the review of your application, and have determined that we cannot approve this application in its present form. We have described below our reasons for this action and, where possible, our recommendations to address these issues.

The supplement cover letter states that a DMF amendment was submitted on September 22, 2015. However, the amendment has not been received by the Agency. This supplement cannot be approved before the DMF deficiencies are fully resolved. The DMF holder needs to submit the information to address the deficiencies.

OTHER

Within one year after the date of this letter, you are required to resubmit or take one of the other actions available under 21 CFR 314.110. If you do not take one of these actions, we will consider your lack of response a request to withdraw the application under 21 CFR 314.65. A resubmission must fully address all the deficiencies listed. A partial response to this letter will not be processed as a resubmission and will not start a new review cycle.

Under 21 CFR 314.102(d), you may request a meeting or telephone conference with us to discuss what steps you need to take before the application may be approved. If you wish to have such a meeting, submit your meeting request as described in the FDA’s *Guidance for Industry - Formal Meetings Between the FDA and Sponsors or Applicants*, May 2009 at

<http://www.fda.gov/downloads/Drugs/GuidanceComplianceRegulatoryInformation/Guidances/UCM153222.pdf>.

This product may be considered to be misbranded under the Federal Food, Drug, and Cosmetic Act if it is marketed with this change before approval of this supplemental application.

If you have any questions, call Teshara G. Bouie, Regulatory Business Process Manager, at (301) 796-1649.

Sincerely,

David Lewis, Ph.D., CMC Lead, on behalf of:

**David B.
Lewis -S**
Digitally signed by David B.
Lewis -S
DN: c=US, o=U.S. Government,
ou=HHS, ou=FDA, ou=People,
cn=David B. Lewis -S,
0.9.2342.19200300.100.1.1=1300
124430
Date: 2016.02.01 11:29:46 -05'00'

Hasmukh Patel, Ph.D.
Division Director (Acting)
Division of Post Marketing Activities I
Office of Lifecycle Drug Products
Office of Pharmaceutical Quality
Center for Drug Evaluation and Research



NDA 20272 / S-075, 20588/S-064, 21444/S-050, 21346/S-054

COMPLETE RESPONSE

Janssen Pharmaceuticals, Inc.
c/o Janssen Research & Development, L.L.C.
Attention: Donna Herdzyk, Manager, CMC Global Regulatory Affairs
1400 Welsh Road
Spring House, PA 19477

Dear Ms. Herdzyk:

Please refer to your supplemental new drug applications (sNDA) dated October 31, 2014, received October 31, 2014, submitted under section 505(b) of the Federal Food, Drug, and Cosmetic Act for the following:

NDA	Supplement #	Drug Product
20272	S-075	Risperdal® (risperidone) Film Coated Tablets
20588	S-064	Risperdal® (risperidone) Oral Solution
21444	S-050	Risperdal® (risperidone) Orally Disintegrating Tablets

We acknowledge receipt of your amendments dated September 30, 2015, which constituted a complete response to our February 27, 2015, action letter.

These “Prior Approval” supplemental new drug applications notify the Agency of an amendment to DMF 11438 to update the drug substance specifications and methods.

We have completed the review of your applications, and have determined that we cannot approve these applications in its present form. We have described below our reasons for this action and, where possible, our recommendations to address these issues.

The supplement cover letters states that a DMF amendment was submitted on September 22, 2015. However, the amendment has not been received by the Agency. These supplements cannot be approved before the DMF deficiencies are fully resolved. The DMF holder needs to submit the information to address the deficiencies.

OTHER

Within one year after the date of this letter, you are required to resubmit or take one of the other actions available under 21 CFR 314.110. If you do not take one of these actions, we will consider your lack of response a request to withdraw the application under 21 CFR 314.65. A

resubmission must fully address all the deficiencies listed. A partial response to this letter will not be processed as a resubmission and will not start a new review cycle.

Under 21 CFR 314.102(d), you may request a meeting or telephone conference with us to discuss what steps you need to take before the application may be approved. If you wish to have such a meeting, submit your meeting request as described in the FDA's *Guidance for Industry - Formal Meetings Between the FDA and Sponsors or Applicants*, May 2009 at <http://www.fda.gov/downloads/Drugs/GuidanceComplianceRegulatoryInformation/Guidances/UCM153222.pdf>.

These products may be considered to be misbranded under the Federal Food, Drug, and Cosmetic Act if it is marketed with this change before approval of these supplemental applications.

If you have any questions, call Teshara G. Bouie, Regulatory Business Process Manager, at (301) 796-1649.

Sincerely,

David Lewis, Ph.D., CMC Lead, on behalf of:

**David B.
Lewis -S**

Digitally signed by David B. Lewis -S
DN: c=US, o=U.S. Government,
ou=HHS, ou=FDA, ou=People,
cn=David B. Lewis -S,
0.9.2342.19200300.100.1.1=1300124
430
Date: 2016.01.29 15:02:49 -05'00'

Hasmukh Patel, Ph.D.
Division Director (Acting)
Division of Post Marketing Activities I
Office of Lifecycle Drug Products
Office of Pharmaceutical Quality
Center for Drug Evaluation and Research

**CENTER FOR DRUG EVALUATION AND
RESEARCH**

APPLICATION NUMBER:

021346Orig1s054

LABELING

HIGHLIGHTS OF PRESCRIBING INFORMATION

These highlights do not include all the information needed to use RISPERDAL[®] safely and effectively. See full prescribing information for RISPERDAL[®].

RISPERDAL[®] (risperidone) tablets, for oral use
RISPERDAL[®] (risperidone) oral solution
RISPERDAL[®] M-TAB[®] (risperidone) orally disintegrating tablets
Initial U.S. Approval: 1993

WARNING: INCREASED MORTALITY IN ELDERLY PATIENTS WITH DEMENTIA-RELATED PSYCHOSIS

See full prescribing information for complete boxed warning.

- Elderly patients with dementia-related psychosis treated with antipsychotic drugs are at an increased risk of death.
- RISPERDAL[®] is not approved for use in patients with dementia-related psychosis. (5.1)

INDICATIONS AND USAGE

RISPERDAL[®] is an atypical antipsychotic indicated for:

- Treatment of schizophrenia (1.1)
- As monotherapy or adjunctive therapy with lithium or valproate, for the treatment of acute manic or mixed episodes associated with Bipolar I Disorder (1.2)
- Treatment of irritability associated with autistic disorder (1.3)

DOSAGE AND ADMINISTRATION

- Recommended daily dosage:

	Initial Dose		Target Dose	Effective Dose Range
Schizophrenia : adults (2.1)	2 mg		4 to 8 mg	4 to 16 mg
Schizophrenia : adolescents (2.1)	0.5 mg		3 mg	1 to 6 mg
Bipolar mania: Adults (2.2)	2 to 3 mg		1 to 6 mg	1 to 6 mg
Bipolar mania: in children and adolescents (2.2)	0.5 mg		1 to 2.5 mg	1 to 6 mg
Irritability associated with autistic disorder (2.3)	0.25 mg (Weight < 20 kg) 0.5 mg (Weight ≥20 kg)		0.5 mg (<20 kg) 1 mg (≥20 kg)	0.5 to 3 mg

- Severe Renal or Hepatic Impairment in Adults: Use a lower starting dose of 0.5 mg twice daily. May increase to dosages above 1.5 mg twice daily at intervals of at least one week. (2.4)
- Oral Solution: Can be administered directly from calibrated pipette or mixed with beverage (water, coffee, orange juice, or low-fat milk). (2.6)
- M-TAB Orally Disintegrating Tablets: Open the blister only when ready to administer, and immediately place tablet under tongue. Can be swallowed with or without liquid. (2.7)

DOSAGE FORMS AND STRENGTHS

- Tablets: 0.25 mg, 0.5 mg, 1 mg, 2 mg, 3 mg, and 4 mg (3)
- Oral solution: 1 mg per mL (3)
- Orally disintegrating tablets: 0.5 mg, 1 mg, 2 mg, 3 mg, and 4 mg (3)

CONTRAINDICATIONS

- Known hypersensitivity to risperidone, paliperidone, or to any excipients in RISPERDAL[®]. (4)

WARNINGS AND PRECAUTIONS

- Cerebrovascular events, including stroke, in elderly patients with dementia-related psychosis: RISPERDAL[®] is not approved for use in patients with dementia-related psychosis. (5.2)
- Neuroleptic Malignant Syndrome: Manage with immediate discontinuation of RISPERDAL[®] and close monitoring. (5.3)
- Tardive dyskinesia: Consider discontinuing RISPERDAL[®] if clinically indicated. (5.4)
- Metabolic Changes: Atypical antipsychotic drugs have been associated with metabolic changes that may increase cardiovascular/ cerebrovascular risk. These metabolic changes include hyperglycemia, dyslipidemia, and weight gain. (5.5)
 - *Hyperglycemia and Diabetes Mellitus*: Monitor patients for symptoms of hyperglycemia including polydipsia, polyuria, polyphagia, and weakness. Monitor glucose regularly in patients with diabetes or at risk for diabetes. (5.5)
 - *Dyslipidemia*: Undesirable alterations have been observed in patients treated with atypical antipsychotics. (5.5)
 - *Weight Gain*: Significant weight gain has been reported. Monitor weight gain. (5.5)
- Hyperprolactinemia: Prolactin elevations occur and persist during chronic administration. (5.6)
- Orthostatic hypotension: For patients at risk, consider a lower starting dose and slower titration. (5.7)
- Leukopenia, Neutropenia, and Agranulocytosis: Perform complete blood counts in patients with a history of clinically significant low white blood cell count (WBC). Consider discontinuing RISPERDAL[®] if a clinically significant decline in WBC occurs in the absence of other causative factors. (5.8)
- Potential for cognitive and motor impairment: Use caution when operating machinery. (5.9)
- Seizures: Use cautiously in patients with a history of seizures or with conditions that lower the seizure threshold. (5.10)

ADVERSE REACTIONS

The most common adverse reactions in clinical trials (≥5% and twice placebo) were parkinsonism, akathisia, dystonia, tremor, sedation, dizziness, anxiety, blurred vision, nausea, vomiting, upper abdominal pain, stomach discomfort, dyspepsia, diarrhea, salivary hypersecretion, constipation, dry mouth, increased appetite, increased weight, fatigue, rash, nasal congestion, upper respiratory tract infection, nasopharyngitis, and pharyngolaryngeal pain. (6)

To report SUSPECTED ADVERSE REACTIONS, contact Janssen Pharmaceuticals, Inc. at 1-800-JANSSEN (1-800-526-7736) or FDA at 1-800-FDA-1088 or www.fda.gov/medwatch

DRUG INTERACTIONS

- Carbamazepine and other enzyme inducers decrease plasma concentrations of risperidone. Increase the RISPERDAL[®] dose up to double the patient's usual dose. Titrate slowly. (7.1)
- Fluoxetine, paroxetine, and other CYP 2D6 enzyme inhibitors increase plasma concentrations of risperidone. Reduce the initial dose. Do not exceed a final dose of 8 mg per day of RISPERDAL[®]. (7.1)

USE IN SPECIFIC POPULATIONS

- Pregnancy: Based on animal data, may cause fetal harm. (8.1)
- Nursing Mothers: Discontinue drug or nursing, taking into consideration the importance of drug to the mother. (8.3)

See 17 for PATIENT COUNSELING INFORMATION

Revised: MM/20YY

FULL PRESCRIBING INFORMATION: CONTENTS*

WARNING: INCREASED MORTALITY IN ELDERLY PATIENTS WITH DEMENTIA-RELATED PSYCHOSIS

1 INDICATIONS AND USAGE

- 1.1 Schizophrenia
- 1.2 Bipolar Mania
- 1.3 Irritability Associated with Autistic Disorder

2 DOSAGE AND ADMINISTRATION

- 2.1 Schizophrenia
- 2.2 Bipolar Mania
- 2.3 Irritability Associated with Autistic Disorder – Pediatrics (Children and Adolescents)
- 2.4 Dosing in Patients with Severe Renal or Hepatic Impairment
- 2.5 Dose Adjustments for Specific Drug Interactions
- 2.6 Administration of RISPERDAL[®] Oral Solution
- 2.7 Directions for Use of RISPERDAL[®] M-TAB[®] Orally Disintegrating Tablets

3 DOSAGE FORMS AND STRENGTHS

4 CONTRAINDICATIONS

5 WARNINGS AND PRECAUTIONS

- 5.1 Increased Mortality in Elderly Patients with Dementia-Related Psychosis
- 5.2 Cerebrovascular Adverse Reactions, Including Stroke, in Elderly Patients with Dementia-Related Psychosis
- 5.3 Neuroleptic Malignant Syndrome
- 5.4 Tardive Dyskinesia
- 5.5 Metabolic Changes
- 5.6 Hyperprolactinemia
- 5.7 Orthostatic Hypotension
- 5.8 Leukopenia, Neutropenia, and Agranulocytosis
- 5.9 Potential for Cognitive and Motor Impairment
- 5.10 Seizures
- 5.11 Dysphagia
- 5.12 Priapism
- 5.13 Body Temperature Regulation
- 5.14 Patients with Phenylketonuria

6 ADVERSE REACTIONS

- 6.1 Clinical Trials Experience
- 6.2 Postmarketing Experience

7 DRUG INTERACTIONS

- 7.1 Pharmacokinetic-related Interactions
- 7.2 Pharmacodynamic-related Interactions

8 USE IN SPECIFIC POPULATIONS

- 8.1 Pregnancy
- 8.2 Labor and Delivery
- 8.3 Nursing Mothers
- 8.4 Pediatric Use

- 8.5 Geriatric Use
- 8.6 Renal Impairment
- 8.7 Hepatic Impairment
- 8.8 Patients with Parkinson's Disease or Lewy Body Dementia

9 DRUG ABUSE AND DEPENDENCE

- 9.1 Controlled Substance
- 9.2 Abuse
- 9.3 Dependence

10 OVERDOSAGE

- 10.1 Human Experience
- 10.2 Management of Overdosage

11 DESCRIPTION

12 CLINICAL PHARMACOLOGY

- 12.1 Mechanism of Action
- 12.2 Pharmacodynamics
- 12.3 Pharmacokinetics

13 NONCLINICAL TOXICOLOGY

- 13.1 Carcinogenesis, Mutagenesis, Impairment of Fertility
- 13.2 Animal Toxicology

14 CLINICAL STUDIES

- 14.1 Schizophrenia
- 14.2 Bipolar Mania - Monotherapy
- 14.3 Bipolar Mania – Adjunctive Therapy with Lithium or Valproate
- 14.4 Irritability Associated with Autistic Disorder

16 HOW SUPPLIED/STORAGE AND HANDLING

- 16.1 How Supplied
- 16.2 Storage and Handling

17 PATIENT COUNSELING INFORMATION

- 17.1 Orthostatic Hypotension
- 17.2 Interference with Cognitive and Motor Performance
- 17.3 Pregnancy
- 17.4 Nursing
- 17.5 Concomitant Medication
- 17.6 Alcohol
- 17.7 Phenylketonurics
- 17.8 Metabolic Changes
- 17.9 Tardive Dyskinesia

*Sections or subsections omitted from the full prescribing information are not listed

FULL PRESCRIBING INFORMATION

WARNING: INCREASED MORTALITY IN ELDERLY PATIENTS WITH DEMENTIA-RELATED PSYCHOSIS

Elderly patients with dementia-related psychosis treated with antipsychotic drugs are at an increased risk of death. RISPERDAL[®] (risperidone) is not approved for the treatment of patients with dementia-related psychosis. *[See Warnings and Precautions (5.1)]*

1 INDICATIONS AND USAGE

1.1 Schizophrenia

RISPERDAL[®] (risperidone) is indicated for the treatment of schizophrenia. Efficacy was established in 4 short-term trials in adults, 2 short-term trials in adolescents (ages 13 to 17 years), and one long-term maintenance trial in adults *[see Clinical Studies (14.1)]*.

1.2 Bipolar Mania

Monotherapy

RISPERDAL[®] is indicated for the treatment of acute manic or mixed episodes associated with Bipolar I Disorder. Efficacy was established in 2 short-term trials in adults and one short-term trial in children and adolescents (ages 10 to 17 years) *[see Clinical Studies (14.2)]*.

Adjunctive Therapy

RISPERDAL[®] adjunctive therapy with lithium or valproate is indicated for the treatment of acute manic or mixed episodes associated with Bipolar I Disorder. Efficacy was established in one short-term trial in adults *[see Clinical Studies (14.3)]*.

1.3 Irritability Associated with Autistic Disorder

RISPERDAL[®] is indicated for the treatment of irritability associated with autistic disorder, including symptoms of aggression towards others, deliberate self-injuriousness, temper tantrums, and quickly changing moods. Efficacy was established in 3 short-term trials in children and adolescents (ages 5 to 17 years) *[see Clinical Studies (14.4)]*.

2 DOSAGE AND ADMINISTRATION

Table 1. Recommended Daily Dosage by Indication

	Initial Dose	Titration (Increments)	Target Dose	Effective Dose Range
Schizophrenia: adults (2.1)	2 mg	1 to 2 mg	4 to 8 mg	4 to 16 mg
Schizophrenia: adolescents (2.2)	0.5 mg	0.5 to 1 mg	3 mg	1 to 6 mg
Bipolar mania: adults (2.2)	2 to 3 mg	1 mg	1 to 6 mg	1 to 6 mg
Bipolar mania: children and adolescents (2.2)	0.5 mg	0.5 to 1 mg	1 to 2.5 mg	1 to 6 mg
Irritability in autistic disorder (2.3)	0.25 mg Can increase to 0.5 mg by Day 4: (body weight less than 20 kg) 0.5 mg Can increase to 1 mg by Day 4: (body weight greater than or equal to 20 kg)	After Day 4, at intervals of > 2 weeks: 0.25 mg (body weight less than 20 kg) 0.5 mg (body weight greater than or equal to 20 kg)	0.5 mg: (body weight less than 20 kg) 1 mg: (body weight greater than or equal to 20 kg)	0.5 to 3 mg

Severe Renal and Hepatic Impairment in Adults: use a lower starting dose of 0.5 mg twice daily. May increase to dosages above 1.5 mg twice daily at intervals of one week or longer.

2.1 Schizophrenia

Adults

Usual Initial Dose

RISPERDAL[®] can be administered once or twice daily. Initial dosing is 2 mg per day. May increase the dose at intervals of 24 hours or greater, in increments of 1 to 2 mg per day, as tolerated, to a recommended dose of 4 to 8 mg per day. In some patients, slower titration may be appropriate. Efficacy has been demonstrated in a range of 4 mg to 16 mg per day. However, doses above 6 mg per day for twice daily dosing were not demonstrated to be more efficacious than lower doses, were associated with more extrapyramidal symptoms and other adverse effects, and are generally not recommended. In a single study supporting once-daily dosing, the efficacy results were generally stronger for 8 mg than for 4 mg. The safety of doses above 16 mg per day has not been evaluated in clinical trials [see *Clinical Studies (14.1)*].

Adolescents

The initial dose is 0.5 mg once daily, administered as a single-daily dose in the morning or evening. The dose may be adjusted at intervals of 24 hours or greater, in increments of 0.5 mg or

1 mg per day, as tolerated, to a recommended dose of 3 mg per day. Although efficacy has been demonstrated in studies of adolescent patients with schizophrenia at doses between 1 mg to 6 mg per day, no additional benefit was observed above 3 mg per day, and higher doses were associated with more adverse events. Doses higher than 6 mg per day have not been studied.

Patients experiencing persistent somnolence may benefit from administering half the daily dose twice daily.

Maintenance Therapy

While it is unknown how long a patient with schizophrenia should remain on RISPERDAL[®], the effectiveness of RISPERDAL[®] 2 mg per day to 8 mg per day at delaying relapse was demonstrated in a controlled trial in adult patients who had been clinically stable for at least 4 weeks and were then followed for a period of 1 to 2 years [see *Clinical Studies (14.1)*]. Both adult and adolescent patients who respond acutely should generally be maintained on their effective dose beyond the acute episode. Patients should be periodically reassessed to determine the need for maintenance treatment.

Reinitiation of Treatment in Patients Previously Discontinued

Although there are no data to specifically address reinitiation of treatment, it is recommended that after an interval off RISPERDAL[®], the initial titration schedule should be followed.

Switching From Other Antipsychotics

There are no systematically collected data to specifically address switching schizophrenic patients from other antipsychotics to RISPERDAL[®], or treating patients with concomitant antipsychotics.

2.2 Bipolar Mania

Usual Dose

Adults

The initial dose range is 2 mg to 3 mg per day. The dose may be adjusted at intervals of 24 hours or greater, in increments of 1 mg per day. The effective dose range is 1 mg to 6 mg per day, as studied in the short-term, placebo-controlled trials. In these trials, short-term (3 week) anti-manic efficacy was demonstrated in a flexible dosage range of 1 mg to 6 mg per day [see *Clinical Studies (14.2, 14.3)*]. RISPERDAL[®] doses higher than 6 mg per day were not studied.

Pediatrics

The initial dose is 0.5 mg once daily, administered as a single-daily dose in the morning or evening. The dose may be adjusted at intervals of 24 hours or greater, in increments of 0.5 mg or 1 mg per day, as tolerated, to the recommended target dose of 1 mg to 2.5 mg per day. Although

efficacy has been demonstrated in studies of pediatric patients with bipolar mania at doses between 0.5 mg and 6 mg per day, no additional benefit was observed above 2.5 mg per day, and higher doses were associated with more adverse events. Doses higher than 6 mg per day have not been studied.

Patients experiencing persistent somnolence may benefit from administering half the daily dose twice daily.

Maintenance Therapy

There is no body of evidence available from controlled trials to guide a clinician in the longer-term management of a patient who improves during treatment of an acute manic episode with RISPERDAL[®]. While it is generally agreed that pharmacological treatment beyond an acute response in mania is desirable, both for maintenance of the initial response and for prevention of new manic episodes, there are no systematically obtained data to support the use of RISPERDAL[®] in such longer-term treatment (i.e., beyond 3 weeks). The physician who elects to use RISPERDAL[®] for extended periods should periodically re-evaluate the long-term risks and benefits of the drug for the individual patient.

2.3 Irritability Associated with Autistic Disorder – Pediatrics (Children and Adolescents)

The dosage of RISPERDAL[®] should be individualized according to the response and tolerability of the patient. The total daily dose of RISPERDAL[®] can be administered once daily, or half the total daily dose can be administered twice daily.

For patients with body weight less than 20 kg, initiate dosing at 0.25 mg per day. For patients with body weight greater than or equal to 20 kg, initiate dosing at 0.5 mg per day. After a minimum of four days, the dose may be increased to the recommended dose of 0.5 mg per day for patients less than 20 kg and 1.0 mg per day for patients greater than or equal to 20 kg. Maintain this dose for a minimum of 14 days. In patients not achieving sufficient clinical response, the dose may be increased at intervals of 2 weeks or greater, in increments of 0.25 mg per day for patients less than 20 kg, or increments of 0.5 mg per day for patients greater than or equal to 20 kg. The effective dose range is 0.5 mg to 3 mg per day. No dosing data are available for children who weigh less than 15 kg.

Once sufficient clinical response has been achieved and maintained, consider gradually lowering the dose to achieve the optimal balance of efficacy and safety. The physician who elects to use RISPERDAL[®] for extended periods should periodically re-evaluate the long-term risks and benefits of the drug for the individual patient.

Patients experiencing persistent somnolence may benefit from a once-daily dose administered at bedtime or administering half the daily dose twice daily, or a reduction of the dose.

2.4 Dosing in Patients with Severe Renal or Hepatic Impairment

For patients with severe renal impairment ($CL_{cr} < 30$ mL/min) or hepatic impairment (10-15 points on Child Pugh System), the initial starting dose is 0.5 mg twice daily. The dose may be increased in increments of 0.5 mg or less, administered twice daily. For doses above 1.5 mg twice daily, increase in intervals of one week or greater [*see Use in Specific Populations (8.6 and 8.7)*].

2.5 Dose Adjustments for Specific Drug Interactions

When RISPERDAL[®] is co-administered with enzyme inducers (e.g., carbamazepine), the dose of RISPERDAL[®] should be increased up to double the patient's usual dose. It may be necessary to decrease the RISPERDAL[®] dose when enzyme inducers such as carbamazepine are discontinued [*see Drug Interactions (7.1)*]. Similar effect may be expected with co-administration of RISPERDAL[®] with other enzyme inducers (e.g., phenytoin, rifampin, and phenobarbital).

When fluoxetine or paroxetine is co-administered with RISPERDAL[®], the dose of RISPERDAL[®] should be reduced. The RISPERDAL[®] dose should not exceed 8 mg per day in adults when co-administered with these drugs. When initiating therapy, RISPERDAL[®] should be titrated slowly. It may be necessary to increase the RISPERDAL[®] dose when enzyme inhibitors such as fluoxetine or paroxetine are discontinued [*see Drug Interactions (7.1)*].

2.6 Administration of RISPERDAL[®] Oral Solution

RISPERDAL[®] Oral Solution can be administered directly from the calibrated pipette, or can be mixed with a beverage prior to administration. RISPERDAL[®] Oral Solution is compatible in the following beverages: water, coffee, orange juice, and low-fat milk; it is NOT compatible with either cola or tea.

2.7 Directions for Use of RISPERDAL[®] M-TAB[®] Orally Disintegrating Tablets

Tablet Accessing

RISPERDAL[®] M-TAB[®] Orally Disintegrating Tablets 0.5 mg, 1 mg, and 2 mg

RISPERDAL[®] M-TAB[®] Orally Disintegrating Tablets 0.5 mg, 1 mg, and 2 mg are supplied in blister packs of 4 tablets each.

Do not open the blister until ready to administer. For single tablet removal, separate one of the four blister units by tearing apart at the perforations. Bend the corner where indicated. Peel back foil to expose the tablet. DO NOT push the tablet through the foil because this could damage the tablet.

RISPERDAL[®] M-TAB[®] Orally Disintegrating Tablets 3 mg and 4 mg

RISPERDAL[®] M-TAB[®] Orally Disintegrating Tablets 3 mg and 4 mg are supplied in a child-resistant pouch containing a blister with 1 tablet each.

The child-resistant pouch should be torn open at the notch to access the blister. Do not open the blister until ready to administer. Peel back foil from the side to expose the tablet. DO NOT push the tablet through the foil, because this could damage the tablet.

Tablet Administration

Using dry hands, remove the tablet from the blister unit and immediately place the entire RISPERDAL[®] M-TAB[®] Orally Disintegrating Tablet on the tongue. The RISPERDAL[®] M-TAB[®] Orally Disintegrating Tablet should be consumed immediately, as the tablet cannot be stored once removed from the blister unit. RISPERDAL[®] M-TAB[®] Orally Disintegrating Tablets disintegrate in the mouth within seconds and can be swallowed subsequently with or without liquid. Patients should not attempt to split or to chew the tablet.

3 DOSAGE FORMS AND STRENGTHS

RISPERDAL[®] Tablets are available in the following strengths and colors: 0.25 mg (dark yellow), 0.5 mg (red-brown), 1 mg (white), 2 mg (orange), 3 mg (yellow), and 4 mg (green). All are capsule shaped, and imprinted with “JANSSEN” on one side and either “Ris 0.25”, “Ris 0.5”, “R1”, “R2”, “R3”, or “R4” on the other side according to their respective strengths.

RISPERDAL[®] Oral Solution is available in a 1 mg/mL strength.

RISPERDAL[®] M-TAB[®] Orally Disintegrating Tablets are available in the following strengths, colors, and shapes: 0.5 mg (light coral, round), 1 mg (light coral, square), 2 mg (coral, square), 3 mg (coral, round), and 4 mg (coral, round). All are biconvex and etched on one side with “R0.5”, “R1”, “R2”, “R3”, or “R4” according to their respective strengths.

4 CONTRAINDICATIONS

RISPERDAL[®] is contraindicated in patients with a known hypersensitivity to either risperidone or paliperidone, or to any of the excipients in the RISPERDAL[®] formulation. Hypersensitivity reactions, including anaphylactic reactions and angioedema, have been reported in patients treated with risperidone and in patients treated with paliperidone. Paliperidone is a metabolite of risperidone.

5 WARNINGS AND PRECAUTIONS

5.1 Increased Mortality in Elderly Patients with Dementia-Related Psychosis

Elderly patients with dementia-related psychosis treated with antipsychotic drugs are at an increased risk of death. Analyses of 17 placebo-controlled trials (modal duration of 10 weeks), largely in patients taking atypical antipsychotic drugs, revealed a risk of death in drug-treated patients of between 1.6 to 1.7 times the risk of death in placebo-treated patients. Over the course of a typical 10-week controlled trial, the rate of death in drug-treated patients was about 4.5%, compared to a rate of about 2.6% in the placebo group. Although the causes of death were varied, most of the deaths appeared to be either cardiovascular (e.g., heart failure, sudden death) or infectious (e.g., pneumonia) in nature. Observational studies suggest that, similar to atypical antipsychotic drugs, treatment with conventional antipsychotic drugs may increase mortality. The extent to which the findings of increased mortality in observational studies may be attributed to the antipsychotic drug as opposed to some characteristic(s) of the patients is not clear.

In two of four placebo-controlled trials in elderly patients with dementia-related psychosis, a higher incidence of mortality was observed in patients treated with furosemide plus RISPERDAL[®] when compared to patients treated with RISPERDAL[®] alone or with placebo plus furosemide. No pathological mechanism has been identified to explain this finding, and no consistent pattern for cause of death was observed.

RISPERDAL[®] (risperidone) is not approved for the treatment of dementia-related psychosis [*see Boxed Warning*].

5.2 Cerebrovascular Adverse Reactions, Including Stroke, in Elderly Patients with Dementia-Related Psychosis

Cerebrovascular adverse reactions (e.g., stroke, transient ischemic attack), including fatalities, were reported in patients (mean age 85 years; range 73-97) in trials of risperidone in elderly patients with dementia-related psychosis. In placebo-controlled trials, there was a significantly higher incidence of cerebrovascular adverse events in patients treated with risperidone compared to patients treated with placebo. RISPERDAL[®] is not approved for the treatment of patients with dementia-related psychosis. [*see Boxed Warning and Warnings and Precautions (5.1)*]

5.3 Neuroleptic Malignant Syndrome

Antipsychotic drugs including RISPERDAL[®] can cause a potentially fatal symptom complex referred to as Neuroleptic Malignant Syndrome (NMS). Clinical manifestations of NMS include hyperpyrexia, muscle rigidity, altered mental status, and autonomic instability (irregular pulse or blood pressure, tachycardia, diaphoresis, and cardiac dysrhythmia). Additional signs may include elevated creatine phosphokinase (CPK), myoglobinuria, rhabdomyolysis, and acute renal failure.

The diagnostic evaluation of patients with this syndrome is complicated. In arriving at a diagnosis, it is important to identify cases in which the clinical presentation includes both serious

medical illness (e.g., pneumonia, systemic infection, etc.) and untreated or inadequately treated extrapyramidal signs and symptoms (EPS). Other important considerations in the differential diagnosis include central anticholinergic toxicity, heat stroke, drug fever, and primary central nervous system pathology.

The management of NMS should include: (1) immediate discontinuation of antipsychotic drugs and other drugs not essential to concurrent therapy; (2) intensive symptomatic treatment and medical monitoring; and (3) treatment of any concomitant serious medical problems for which specific treatments are available. There is no general agreement about specific pharmacological treatment regimens for uncomplicated NMS.

If a patient requires antipsychotic drug treatment after recovery from NMS, the potential reintroduction of drug therapy should be carefully considered. The patient should be carefully monitored, since recurrences of NMS have been reported.

5.4 Tardive Dyskinesia

A syndrome of potentially irreversible, involuntary, dyskinetic movements may develop in patients treated with antipsychotic drugs. The risk of developing tardive dyskinesia and the likelihood that it will become irreversible are believed to increase as the duration of treatment and the total cumulative dose of antipsychotic drugs administered to the patient increase. However, the syndrome can develop, although much less commonly, after relatively brief treatment periods at low doses.

There is no known treatment for established cases of tardive dyskinesia, although the syndrome may remit, partially or completely, if antipsychotic treatment is withdrawn. Antipsychotic treatment, itself, however, may suppress (or partially suppress) the signs and symptoms of the syndrome and thereby may possibly mask the underlying process. The effect that symptomatic suppression has upon the long-term course of the syndrome is unknown.

Given these considerations, prescribe RISPERDAL[®] in a manner that is most likely to minimize the occurrence of tardive dyskinesia. Chronic antipsychotic treatment should generally be reserved for patients who suffer from a chronic illness that: (1) is known to respond to antipsychotic drugs, and (2) for whom alternative, equally effective, but potentially less harmful treatments are not available or appropriate. In patients who do require chronic treatment, the smallest dose and the shortest duration of treatment producing a satisfactory clinical response should be sought. The need for continued treatment should be reassessed periodically.

If signs and symptoms of tardive dyskinesia appear in a patient treated with RISPERDAL[®], consider drug discontinuation. However, some patients may require treatment with RISPERDAL[®] despite the presence of the syndrome.

5.5 Metabolic Changes

Atypical antipsychotic drugs have been associated with metabolic changes that may increase cardiovascular/cerebrovascular risk. These metabolic changes include hyperglycemia, dyslipidemia, and body weight gain. While all of the drugs in the class have been shown to produce some metabolic changes, each drug has its own specific risk profile.

Hyperglycemia and Diabetes Mellitus

Hyperglycemia and diabetes mellitus, in some cases extreme and associated with ketoacidosis or hyperosmolar coma or death, have been reported in patients treated with atypical antipsychotics including RISPERDAL[®]. Assessment of the relationship between atypical antipsychotic use and glucose abnormalities is complicated by the possibility of an increased background risk of diabetes mellitus in patients with schizophrenia and the increasing incidence of diabetes mellitus in the general population. Given these confounders, the relationship between atypical antipsychotic use and hyperglycemia-related adverse events is not completely understood. However, epidemiological studies suggest an increased risk of treatment-emergent hyperglycemia-related adverse events in patients treated with the atypical antipsychotics. Precise risk estimates for hyperglycemia-related adverse events in patients treated with atypical antipsychotics are not available.

Patients with an established diagnosis of diabetes mellitus who are started on atypical antipsychotics, including RISPERDAL[®], should be monitored regularly for worsening of glucose control. Patients with risk factors for diabetes mellitus (e.g., obesity, family history of diabetes) who are starting treatment with atypical antipsychotics, including RISPERDAL[®], should undergo fasting blood glucose testing at the beginning of treatment and periodically during treatment. Any patient treated with atypical antipsychotics, including RISPERDAL[®], should be monitored for symptoms of hyperglycemia including polydipsia, polyuria, polyphagia, and weakness. Patients who develop symptoms of hyperglycemia during treatment with atypical antipsychotics, including RISPERDAL[®], should undergo fasting blood glucose testing. In some cases, hyperglycemia has resolved when the atypical antipsychotic, including RISPERDAL[®], was discontinued; however, some patients required continuation of anti-diabetic treatment despite discontinuation of RISPERDAL[®].

Pooled data from three double-blind, placebo-controlled schizophrenia studies and four double-blind, placebo-controlled bipolar monotherapy studies are presented in Table 2.

Table 2. Change in Random Glucose from Seven Placebo-Controlled, 3- to 8-Week, Fixed- or Flexible-Dose Studies in Adult Subjects with Schizophrenia or Bipolar Mania

	Placebo	RISPERDAL [®]	
		1-8 mg/day	>8-16 mg/day
	n=555	n=748	n=164
	Mean change from baseline (mg/dL)		
Serum Glucose	-1.4	0.8	0.6
	Proportion of patients with shifts		
Serum Glucose (<140 mg/dL to ≥200 mg/dL)	0.6% (3/525)	0.4% (3/702)	0% (0/158)

In longer-term, controlled and uncontrolled studies, RISPERDAL[®] was associated with a mean change in glucose of +2.8 mg/dL at Week 24 (n=151) and +4.1 mg/dL at Week 48 (n=50).

Data from the placebo-controlled 3- to 6-week study in children and adolescents with schizophrenia (13-17 years of age), bipolar mania (10-17 years of age), or autistic disorder (5 to 17 years of age) are presented in Table 3.

Table 3. Change in Fasting Glucose from Three Placebo-Controlled, 3- to 6-Week, Fixed-Dose Studies in Children and Adolescents with Schizophrenia (13-17 years of age), Bipolar Mania (10-17 years of age), or Autistic Disorder (5 to 17 years of age)

	Placebo	RISPERDAL [®]
		0.5-6 mg/day
	n=76	n=135
	Mean change from baseline (mg/dL)	
Serum Glucose	-1.3	2.6
	Proportion of patients with shifts	
Serum Glucose (<100 mg/dL to ≥126 mg/dL)	0% (0/64)	0.8% (1/120)

In longer-term, uncontrolled, open-label extension pediatric studies, RISPERDAL[®] was associated with a mean change in fasting glucose of +5.2 mg/dL at Week 24 (n=119).

Dyslipidemia

Undesirable alterations in lipids have been observed in patients treated with atypical antipsychotics.

Pooled data from 7 placebo-controlled, 3- to 8- week, fixed- or flexible-dose studies in adult subjects with schizophrenia or bipolar mania are presented in Table 4.

Table 4. Change in Random Lipids from Seven Placebo-Controlled, 3- to 8-Week, Fixed- or Flexible-Dose Studies in Adult Subjects with Schizophrenia or Bipolar Mania

	Placebo	RISPERDAL [®]	
		1-8 mg/day	>8-16 mg/day
		Mean change from baseline (mg/dL)	
Cholesterol	n=559	n=742	n=156
Change from baseline	0.6	6.9	1.8
Triglycerides	n=183	n=307	n=123
Change from baseline	-17.4	-4.9	-8.3
		Proportion of patients With Shifts	
Cholesterol			
(<200 mg/dL to ≥240 mg/dL)	2.7%	4.3%	6.3%
	(10/368)	(22/516)	(6/96)
Triglycerides			
(<500 mg/dL to ≥500 mg/dL)	1.1%	2.7%	2.5%
	(2/180)	(8/301)	(3/121)

In longer-term, controlled and uncontrolled studies, RISPERDAL[®] was associated with a mean change in (a) non-fasting cholesterol of +4.4 mg/dL at Week 24 (n=231) and +5.5 mg/dL at Week 48 (n=86); and (b) non-fasting triglycerides of +19.9 mg/dL at Week 24 (n=52).

Pooled data from 3 placebo-controlled, 3- to 6-week, fixed-dose studies in children and adolescents with schizophrenia (13-17 years of age), bipolar mania (10-17 years of age), or autistic disorder (5-17 years of age) are presented in Table 5. **Table 5. Change in Fasting Lipids from Three Placebo-Controlled, 3- to 6-Week, Fixed-Dose Studies in Children and Adolescents with Schizophrenia (13-17 Years of Age), Bipolar Mania (10-17 Years of Age), or Autistic Disorder (5 to 17 Years of Age)**

	Placebo	RISPERDAL [®] 0.5-6 mg/day
	Mean change from baseline (mg/dL)	
Cholesterol	n=74	n=133
Change from baseline	0.3	-0.3
LDL	n=22	n=22
Change from baseline	3.7	0.5
HDL	n=22	n=22
Change from baseline	1.6	-1.9
Triglycerides	n=77	n=138
Change from baseline	-9.0	-2.6
	Proportion of patients with shifts	
Cholesterol (<170 mg/dL to ≥200 mg/dL)	2.4% (1/42)	3.8% (3/80)
LDL (<110 mg/dL to ≥130 mg/dL)	0% (0/16)	0% (0/16)
HDL (≥40 mg/dL to <40 mg/dL)	0% (0/19)	10% (2/20)
Triglycerides (<150 mg/dL to ≥200 mg/dL)	1.5% (1/65)	7.1% (8/113)

In longer-term, uncontrolled, open-label extension pediatric studies, RISPERDAL[®] was associated with a mean change in (a) fasting cholesterol of +2.1 mg/dL at Week 24 (n=114); (b) fasting LDL of -0.2 mg/dL at Week 24 (n=103); (c) fasting HDL of +0.4 mg/dL at Week 24 (n=103); and (d) fasting triglycerides of +6.8 mg/dL at Week 24 (n=120).

Weight Gain

Weight gain has been observed with atypical antipsychotic use. Clinical monitoring of weight is recommended.

Data on mean changes in body weight and the proportion of subjects meeting a weight gain criterion of 7% or greater of body weight from 7 placebo-controlled, 3- to 8- week, fixed- or flexible-dose studies in adult subjects with schizophrenia or bipolar mania are presented in Table 6.

Table 6. Mean Change in Body Weight (kg) and the Proportion of Subjects with $\geq 7\%$ Gain in Body Weight From Seven Placebo-Controlled, 3- to 8-Week, Fixed- or Flexible-Dose Studies in Adult Subjects With Schizophrenia or Bipolar Mania

	Placebo (n=597)	RISPERDAL [®]	
		1-8 mg/day (n=769)	>8-16 mg/day (n=158)
Weight (kg)			
Change from baseline	-0.3	0.7	2.2
Weight Gain			
$\geq 7\%$ increase from baseline	2.9%	8.7%	20.9%

In longer-term, controlled and uncontrolled studies, RISPERDAL[®] was associated with a mean change in weight of +4.3 kg at Week 24 (n=395) and +5.3 kg at Week 48 (n=203).

Data on mean changes in body weight and the proportion of subjects meeting the criterion of $\geq 7\%$ gain in body weight from nine placebo-controlled, 3- to 8-week, fixed-dose studies in children and adolescents with schizophrenia (13-17 years of age), bipolar mania (10-17 years of age), autistic disorder (5-17 years of age), or other psychiatric disorders (5-17 years of age) are presented in Table 7.

Table 7. Mean Change in Body Weight (kg) and the Proportion of Subjects With $\geq 7\%$ Gain in Body Weight From Nine Placebo-Controlled, 3- to 8-Week, Fixed-Dose Studies in Children and Adolescents With Schizophrenia (13-17 Years of Age), Bipolar Mania (10-17 Years of Age), Autistic Disorder (5 to 17 Years of Age) or Other Psychiatric Disorders (5-17 Years of Age)

	Placebo (n=375)	RISPERDAL [®] 0.5-6 mg/day (n=448)
Weight (kg)		
Change from baseline	0.6	2.0
Weight Gain		
$\geq 7\%$ increase from baseline	6.9%	32.6%

In longer-term, uncontrolled, open-label extension pediatric studies, RISPERDAL[®] was associated with a mean change in weight of +5.5 kg at Week 24 (n=748) and +8.0 kg at Week 48 (n=242).

In a long-term, open-label extension study in adolescent patients with schizophrenia, weight increase was reported as a treatment-emergent adverse event in 14% of patients. In 103 adolescent patients with schizophrenia, a mean increase of 9.0 kg was observed after 8 months of RISPERDAL[®] treatment. The majority of that increase was observed within the first 6 months. The average percentiles at baseline and 8 months, respectively, were 56 and 72 for weight, 55 and 58 for height, and 51 and 71 for body mass index.

In long-term, open-label trials (studies in patients with autistic disorder or other psychiatric disorders), a mean increase of 7.5 kg after 12 months of RISPERDAL[®] treatment was observed,

which was higher than the expected normal weight gain (approximately 3 to 3.5 kg per year adjusted for age, based on Centers for Disease Control and Prevention normative data). The majority of that increase occurred within the first 6 months of exposure to RISPERDAL[®]. The average percentiles at baseline and 12 months, respectively, were 49 and 60 for weight, 48 and 53 for height, and 50 and 62 for body mass index.

In one 3-week, placebo-controlled trial in children and adolescent patients with acute manic or mixed episodes of bipolar I disorder, increases in body weight were higher in the RISPERDAL[®] groups than the placebo group, but not dose related (1.90 kg in the RISPERDAL[®] 0.5-2.5 mg group, 1.44 kg in the RISPERDAL[®] 3-6 mg group, and 0.65 kg in the placebo group). A similar trend was observed in the mean change from baseline in body mass index.

When treating pediatric patients with RISPERDAL[®] for any indication, weight gain should be assessed against that expected with normal growth.

5.6 Hyperprolactinemia

As with other drugs that antagonize dopamine D₂ receptors, RISPERDAL[®] elevates prolactin levels and the elevation persists during chronic administration. RISPERDAL[®] is associated with higher levels of prolactin elevation than other antipsychotic agents.

Hyperprolactinemia may suppress hypothalamic GnRH, resulting in reduced pituitary gonadotropin secretion. This, in turn, may inhibit reproductive function by impairing gonadal steroidogenesis in both female and male patients. Galactorrhea, amenorrhea, gynecomastia, and impotence have been reported in patients receiving prolactin-elevating compounds. Long-standing hyperprolactinemia when associated with hypogonadism may lead to decreased bone density in both female and male subjects.

Tissue culture experiments indicate that approximately one-third of human breast cancers are prolactin dependent *in vitro*, a factor of potential importance if the prescription of these drugs is contemplated in a patient with previously detected breast cancer. An increase in pituitary gland, mammary gland, and pancreatic islet cell neoplasia (mammary adenocarcinomas, pituitary and pancreatic adenomas) was observed in the risperidone carcinogenicity studies conducted in mice and rats [see *Nonclinical Toxicology (13.1)*]. Neither clinical studies nor epidemiologic studies conducted to date have shown an association between chronic administration of this class of drugs and tumorigenesis in humans; the available evidence is considered too limited to be conclusive at this time.

5.7 Orthostatic Hypotension

RISPERDAL[®] may induce orthostatic hypotension associated with dizziness, tachycardia, and in some patients, syncope, especially during the initial dose-titration period, probably reflecting its alpha-adrenergic antagonistic properties. Syncope was reported in 0.2% (6/2607) of RISPERDAL[®]-treated patients in Phase 2 and 3 studies in adults with schizophrenia. The risk of orthostatic hypotension and syncope may be minimized by limiting the initial dose to 2 mg total (either once daily or 1 mg twice daily) in normal adults and 0.5 mg twice daily in the elderly and patients with renal or hepatic impairment [see *Dosage and Administration* (2.1, 2.4)]. Monitoring of orthostatic vital signs should be considered in patients for whom this is of concern. A dose reduction should be considered if hypotension occurs. RISPERDAL[®] should be used with particular caution in patients with known cardiovascular disease (history of myocardial infarction or ischemia, heart failure, or conduction abnormalities), cerebrovascular disease, and conditions which would predispose patients to hypotension, e.g., dehydration and hypovolemia. Clinically significant hypotension has been observed with concomitant use of RISPERDAL[®] and antihypertensive medication.

5.8 Leukopenia, Neutropenia, and Agranulocytosis

Class Effect: In clinical trial and/or postmarketing experience, events of leukopenia/neutropenia have been reported temporally related to antipsychotic agents, including RISPERDAL[®]. Agranulocytosis has also been reported.

Possible risk factors for leukopenia/neutropenia include pre-existing low white blood cell count (WBC) and history of drug-induced leukopenia/neutropenia. Patients with a history of a clinically significant low WBC or a drug-induced leukopenia/neutropenia should have their complete blood count (CBC) monitored frequently during the first few months of therapy and discontinuation of RISPERDAL[®] should be considered at the first sign of a clinically significant decline in WBC in the absence of other causative factors.

Patients with clinically significant neutropenia should be carefully monitored for fever or other symptoms or signs of infection and treated promptly if such symptoms or signs occur. Patients with severe neutropenia (absolute neutrophil count <1000/mm³) should discontinue RISPERDAL[®] and have their WBC followed until recovery.

5.9 Potential for Cognitive and Motor Impairment

Somnolence was a commonly reported adverse reaction associated with RISPERDAL[®] treatment, especially when ascertained by direct questioning of patients. This adverse reaction is dose-related, and in a study utilizing a checklist to detect adverse events, 41% of the high-dose patients (RISPERDAL[®] 16 mg/day) reported somnolence compared to 16% of placebo patients.

Direct questioning is more sensitive for detecting adverse events than spontaneous reporting, by which 8% of RISPERDAL[®] 16 mg/day patients and 1% of placebo patients reported somnolence as an adverse reaction. Since RISPERDAL[®] has the potential to impair judgment, thinking, or motor skills, patients should be cautioned about operating hazardous machinery, including automobiles, until they are reasonably certain that RISPERDAL[®] therapy does not affect them adversely.

5.10 Seizures

During premarketing testing in adult patients with schizophrenia, seizures occurred in 0.3% (9/2607) of RISPERDAL[®]-treated patients, two in association with hyponatremia. RISPERDAL[®] should be used cautiously in patients with a history of seizures.

5.11 Dysphagia

Esophageal dysmotility and aspiration have been associated with antipsychotic drug use. Aspiration pneumonia is a common cause of morbidity and mortality in patients with advanced Alzheimer's dementia. RISPERDAL[®] and other antipsychotic drugs should be used cautiously in patients at risk for aspiration pneumonia. *[see Boxed Warning and Warnings and Precautions (5.1)]*

5.12 Priapism

Priapism has been reported during postmarketing surveillance. Severe priapism may require surgical intervention.

5.13 Body Temperature Regulation

Disruption of body temperature regulation has been attributed to antipsychotic agents. Both hyperthermia and hypothermia have been reported in association with oral RISPERDAL[®] use. Caution is advised when prescribing for patients who will be exposed to temperature extremes.

5.14 Patients with Phenylketonuria

Inform patients that RISPERDAL[®] M-TAB[®] Orally Disintegrating Tablets contain phenylalanine. Phenylalanine is a component of aspartame. Each 4 mg RISPERDAL[®] M-TAB[®] Orally Disintegrating Tablet contains 0.84 mg phenylalanine; each 3 mg RISPERDAL[®] M-TAB[®] Orally Disintegrating Tablet contains 0.63 mg phenylalanine; each 2 mg RISPERDAL[®] M-TAB[®] Orally Disintegrating Tablet contains 0.42 mg phenylalanine; each 1 mg RISPERDAL[®] M-TAB[®] Orally Disintegrating Tablet contains 0.28 mg phenylalanine; and each 0.5 mg RISPERDAL[®] M-TAB[®] Orally Disintegrating Tablet contains 0.14 mg phenylalanine.

6 ADVERSE REACTIONS

The following are discussed in more detail in other sections of the labeling:

- Increased mortality in elderly patients with dementia-related psychosis [*see Boxed Warning and Warnings and Precautions (5.1)*]
- Cerebrovascular adverse events, including stroke, in elderly patients with dementia-related psychosis [*see Warnings and Precautions (5.2)*]
- Neuroleptic malignant syndrome [*see Warnings and Precautions (5.3)*]
- Tardive dyskinesia [*see Warnings and Precautions (5.4)*]
- Metabolic Changes (Hyperglycemia and diabetes mellitus, Dyslipidemia, and Weight Gain) [*see Warnings and Precautions (5.5)*]
- Hyperprolactinemia [*see Warnings and Precautions (5.6)*]
- Orthostatic hypotension [*see Warnings and Precautions (5.7)*]
- Leukopenia, neutropenia, and agranulocytosis [*see Warnings and Precautions (5.8)*]
- Potential for cognitive and motor impairment [*see Warnings and Precautions (5.9)*]
- Seizures [*see Warnings and Precautions (5.10)*]
- Dysphagia [*see Warnings and Precautions (5.11)*]
- Priapism [*see Warnings and Precautions (5.12)*]
- Disruption of body temperature regulation [*see Warnings and Precautions (5.13)*]
- Patients with Phenylketonuria [*see Warnings and Precautions (5.14)*].

The most common adverse reactions in clinical trials (>5% and twice placebo) were parkinsonism, akathisia, dystonia, tremor, sedation, dizziness, anxiety, blurred vision, nausea, vomiting, upper abdominal pain, stomach discomfort, dyspepsia, diarrhea, salivary hypersecretion, constipation, dry mouth, increased appetite, increased weight, fatigue, rash, nasal congestion, upper respiratory tract infection, nasopharyngitis, and pharyngolaryngeal pain.

The most common adverse reactions that were associated with discontinuation from clinical trials (causing discontinuation in >1% of adults and/or >2% of pediatrics) were nausea,

somnolence, sedation, vomiting, dizziness, and akathisia [*see Adverse Reactions, Discontinuations Due to Adverse Reactions (6.1)*].

The data described in this section are derived from a clinical trial database consisting of 9803 adult and pediatric patients exposed to one or more doses of RISPERDAL[®] for the treatment of schizophrenia, bipolar mania, autistic disorder, and other psychiatric disorders in pediatrics and elderly patients with dementia. Of these 9803 patients, 2687 were patients who received RISPERDAL[®] while participating in double-blind, placebo-controlled trials. The conditions and duration of treatment with RISPERDAL[®] varied greatly and included (in overlapping categories) double-blind, fixed- and flexible-dose, placebo- or active-controlled studies and open-label phases of studies, inpatients and outpatients, and short-term (up to 12 weeks) and longer-term (up to 3 years) exposures. Safety was assessed by collecting adverse events and performing physical examinations, vital signs, body weights, laboratory analyses, and ECGs.

6.1 Clinical Trials Experience

Because clinical trials are conducted under widely varying conditions, adverse reaction rates observed in the clinical trials of a drug cannot be directly compared to rates in the clinical trials of another drug and may not reflect the rates observed in clinical practice.

Commonly-Observed Adverse Reactions in Double-Blind, Placebo-Controlled Clinical Trials – Schizophrenia

Adult Patients with Schizophrenia

Table 8 lists the adverse reactions reported in 2% or more of RISPERDAL[®]-treated adult patients with schizophrenia in three 4- to 8-week, double-blind, placebo-controlled trials.

Table 8. Adverse Reactions in $\geq 2\%$ of RISPERDAL[®]-Treated Adult Patients (and greater than placebo) with Schizophrenia in Double-Blind, Placebo-Controlled Trials

System/Organ Class Adverse Reaction	Percentage of Patients Reporting Reaction RISPERDAL [®]		
	2-8 mg per day (N=366)	>8-16 mg per day (N=198)	Placebo (N=225)
Cardiac Disorders			
Tachycardia	1	3	0
Eye Disorders			
Vision blurred	3	1	1
Gastrointestinal Disorders			
Nausea	9	4	4
Constipation	8	9	6
Dyspepsia	8	6	5
Dry mouth	4	0	1
Abdominal discomfort	3	1	1
Salivary hypersecretion	2	1	<1
Diarrhea	2	1	1
General Disorders			
Fatigue	3	1	0
Chest pain	2	2	1
Asthenia	2	1	<1
Infections and Infestations			
Nasopharyngitis	3	4	3
Upper respiratory tract infection	2	3	1
Sinusitis	1	2	1
Urinary tract infection	1	3	0
Investigations			
Blood creatine phosphokinase increased	1	2	<1
Heart rate increased	<1	2	0
Musculoskeletal and Connective Tissue Disorders			
Back pain	4	1	1
Arthralgia	2	3	<1
Pain in extremity	2	1	1

System/Organ Class Adverse Reaction	Percentage of Patients Reporting Reaction RISPERDAL®		
	2-8 mg per day (N=366)	>8-16 mg per day (N=198)	Placebo (N=225)
Nervous System Disorders			
Parkinsonism*	14	17	8
Akathisia*	10	10	3
Sedation	10	5	2
Dizziness	7	4	2
Dystonia*	3	4	2
Tremor*	2	3	1
Dizziness postural	2	0	0
Psychiatric Disorders			
Insomnia	32	25	27
Anxiety	16	11	11
Respiratory, Thoracic and Mediastinal Disorders			
Nasal congestion	4	6	2
Dyspnea	1	2	0
Epistaxis	<1	2	0
Skin and Subcutaneous Tissue Disorders			
Rash	1	4	1
Dry skin	1	3	0
Vascular Disorders			
Orthostatic hypotension	2	1	0

* Parkinsonism includes extrapyramidal disorder, musculoskeletal stiffness, parkinsonism, cogwheel rigidity, akinesia, bradykinesia, hypokinesia, masked facies, muscle rigidity, and Parkinson's disease. Akathisia includes akathisia and restlessness. Dystonia includes dystonia, muscle spasms, muscle contractions involuntary, muscle contracture, oculogyration, tongue paralysis. Tremor includes tremor and parkinsonian rest tremor.

Pediatric Patients with Schizophrenia

Table 9 lists the adverse reactions reported in 5% or more of RISPERDAL[®]-treated pediatric patients with schizophrenia in a 6-week double-blind, placebo-controlled trial.

Table 9. Adverse Reactions in ≥5% of RISPERDAL[®]-Treated Pediatric Patients (and greater than placebo) with Schizophrenia in a Double-Blind Trial

System/Organ Class Adverse Reaction	Percentage of Patients Reporting Reaction RISPERDAL [®]		
	1-3 mg per day (N=55)	4-6 mg per day (N=51)	Placebo (N=54)
Gastrointestinal Disorders			
Salivary hypersecretion	0	10	2
Nervous System Disorders			
Sedation	24	12	4
Parkinsonism*	16	28	11
Tremor	11	10	6
Akathisia*	9	10	4
Dizziness	7	14	2
Dystonia*	2	6	0
Psychiatric Disorders			
Anxiety	7	6	0

* Parkinsonism includes extrapyramidal disorder, muscle rigidity, musculoskeletal stiffness, and hypokinesia. Akathisia includes akathisia and restlessness. Dystonia includes dystonia and oculogyration.

Commonly-Observed Adverse Reactions in Double-Blind, Placebo-Controlled Clinical Trials – Bipolar Mania

Adult Patients with Bipolar Mania

Table 10 lists the adverse reactions reported in 2% or more of RISPERDAL[®]-treated adult patients with bipolar mania in four 3-week, double-blind, placebo-controlled monotherapy trials.

Table 10. Adverse Reactions in $\geq 2\%$ of RISPERDAL[®]-Treated Adult Patients (and greater than placebo) with Bipolar Mania in Double-Blind, Placebo-Controlled Monotherapy Trials

System/Organ Class Adverse Reaction	Percentage of Patients Reporting Reaction	
	RISPERDAL [®] 1-6 mg per day (N=448)	Placebo (N=424)
Eye Disorders		
Vision blurred	2	1
Gastrointestinal Disorders		
Nausea	5	2
Diarrhea	3	2
Salivary hypersecretion	3	1
Stomach discomfort	2	<1
General Disorders		
Fatigue	2	1
Nervous System Disorders		
Parkinsonism*	25	9
Sedation	11	4
Akathisia*	9	3
Tremor*	6	3
Dizziness	6	5
Dystonia*	5	1
Lethargy	2	1

* Parkinsonism includes extrapyramidal disorder, parkinsonism, musculoskeletal stiffness, hypokinesia, muscle rigidity, muscle tightness, bradykinesia, cogwheel rigidity. Akathisia includes akathisia and restlessness. Tremor includes tremor and parkinsonian rest tremor. Dystonia includes dystonia, muscle spasms, oculogyration, torticollis.

Table 11 lists the adverse reactions reported in 2% or more of RISPERDAL[®]-treated adult patients with bipolar mania in two 3-week, double-blind, placebo-controlled adjuvant therapy trials.

Table 11. Adverse Reactions in $\geq 2\%$ of RISPERDAL[®]-Treated Adult Patients (and greater than placebo) with Bipolar Mania in Double-Blind, Placebo-Controlled Adjuvant Therapy Trials

System/Organ Class Adverse Reaction	Percentage of Patients Reporting Reaction	
	RISPERDAL [®] + Mood Stabilizer (N=127)	Placebo + Mood Stabilizer (N=126)
Cardiac Disorders		
Palpitations	2	0
Gastrointestinal Disorders		
Dyspepsia	9	8
Nausea	6	4
Diarrhea	6	4
Salivary hypersecretion	2	0
General Disorders		
Chest pain	2	1
Infections and Infestations		
Urinary tract infection	2	1
Nervous System Disorders		
Parkinsonism*	14	4
Sedation	9	4
Akathisia*	8	0
Dizziness	7	2
Tremor	6	2
Lethargy	2	1
Psychiatric Disorders		
Anxiety	3	2
Respiratory, Thoracic and Mediastinal Disorders		
Pharyngolaryngeal pain	5	2
Cough	2	0

* Parkinsonism includes extrapyramidal disorder, hypokinesia and bradykinesia. Akathisia includes hyperkinesia and akathisia.

Pediatric Patients with Bipolar Mania

Table 12 lists the adverse reactions reported in 5% or more of RISPERDAL[®]-treated pediatric patients with bipolar mania in a 3-week double-blind, placebo-controlled trial.

Table 12. Adverse Reactions in $\geq 5\%$ of RISPERDAL[®]-Treated Pediatric Patients (and greater than placebo) with Bipolar Mania in Double-Blind, Placebo-Controlled Trials

System/Organ Class Adverse Reaction	Percentage of Patients Reporting Reaction		
	RISPERDAL [®] 0.5-2.5 mg per day (N=50)	3-6 mg per day (N=61)	Placebo (N=58)
Eye Disorders			
Vision blurred	4	7	0
Gastrointestinal Disorders			
Abdominal pain upper	16	13	5
Nausea	16	13	7
Vomiting	10	10	5
Diarrhea	8	7	2
Dyspepsia	10	3	2
Stomach discomfort	6	0	2
General Disorders			
Fatigue	18	30	3
Metabolism and Nutrition Disorders			
Increased appetite	4	7	2
Nervous System Disorders			
Sedation	42	56	19
Dizziness	16	13	5
Parkinsonism*	6	12	3
Dystonia*	6	5	0
Akathisia*	0	8	2
Psychiatric Disorders			
Anxiety	0	8	3
Respiratory, Thoracic and Mediastinal Disorders			
Pharyngolaryngeal pain	10	3	5
Skin and Subcutaneous Tissue Disorders			
Rash	0	7	2

* Parkinsonism includes musculoskeletal stiffness, extrapyramidal disorder, bradykinesia, and nuchal rigidity. Dystonia includes dystonia, laryngospasm, and muscle spasms. Akathisia includes restlessness and akathisia.

Commonly-Observed Adverse Reactions in Double-Blind, Placebo-Controlled Clinical Trials - Autistic Disorder

Table 13 lists the adverse reactions reported in 5% or more of RISPERDAL[®]-treated pediatric patients treated for irritability associated with autistic disorder in two 8-week, double-blind, placebo-controlled trials and one 6-week double-blind, placebo-controlled study.

Table 13. Adverse Reactions in ≥5% of RISPERDAL[®]-Treated Pediatric Patients (and greater than placebo) Treated for Irritability Associated with Autistic Disorder in Double-Blind, Placebo-Controlled Trials

System/Organ Class Adverse Reaction	Percentage of Patients Reporting Reaction	
	RISPERDAL [®] 0.5-4.0 mg/day (N=107)	Placebo (N=115)
Gastrointestinal Disorders		
Vomiting	20	17
Constipation	17	6
Dry mouth	10	4
Nausea	8	5
Salivary hypersecretion	7	1
General Disorders and Administration Site Conditions		
Fatigue	31	9
Pyrexia	16	13
Thirst	7	4
Infections and Infestations		
Nasopharyngitis	19	9
Rhinitis	9	7
Upper respiratory tract infection	8	3
Investigations		
Weight increased	8	2
Metabolism and Nutrition Disorders		
Increased appetite	44	15
Nervous System Disorders		
Sedation	63	15
Drooling	12	4
Headache	12	10
Tremor	8	1
Dizziness	8	2
Parkinsonism*	8	1
Renal and Urinary Disorders		
Enuresis	16	10
Respiratory, Thoracic and Mediastinal Disorders		
Cough	17	12
Rhinorrhea	12	10
Nasal congestion	10	4
Skin and Subcutaneous Tissue Disorders		
Rash	8	5

*Parkinsonism includes musculoskeletal stiffness, extrapyramidal disorder, muscle rigidity, cogwheel rigidity, and muscle tightness.

Other Adverse Reactions Observed During the Clinical Trial Evaluation of Risperidone

The following additional adverse reactions occurred across all placebo-controlled, active-controlled, and open-label studies of RISPERDAL[®] in adults and pediatric patients.

Blood and Lymphatic System Disorders: anemia, granulocytopenia, neutropenia

Cardiac Disorders: sinus bradycardia, sinus tachycardia, atrioventricular block first degree, bundle branch block left, bundle branch block right, atrioventricular block

Ear and Labyrinth Disorders: ear pain, tinnitus

Endocrine Disorders: hyperprolactinemia

Eye Disorders: ocular hyperemia, eye discharge, conjunctivitis, eye rolling, eyelid edema, eye swelling, eyelid margin crusting, dry eye, lacrimation increased, photophobia, glaucoma, visual acuity reduced

Gastrointestinal Disorders: dysphagia, fecaloma, fecal incontinence, gastritis, lip swelling, cheilitis, apyhalism

General Disorders: edema peripheral, thirst, gait disturbance, influenza-like illness, pitting edema, edema, chills, sluggishness, malaise, chest discomfort, face edema, discomfort, generalized edema, drug withdrawal syndrome, peripheral coldness, feeling abnormal

Immune System Disorders: drug hypersensitivity

Infections and Infestations: pneumonia, influenza, ear infection, viral infection, pharyngitis, tonsillitis, bronchitis, eye infection, localized infection, cystitis, cellulitis, otitis media, onychomycosis, acarodermatitis, bronchopneumonia, respiratory tract infection, tracheobronchitis, otitis media chronic

Investigations: body temperature increased, blood prolactin increased, alanine aminotransferase increased, electrocardiogram abnormal, eosinophil count increased, white blood cell count decreased, blood glucose increased, hemoglobin decreased, hematocrit decreased, body temperature decreased, blood pressure decreased, transaminases increased

Metabolism and Nutrition Disorders: decreased appetite, polydipsia, anorexia

Musculoskeletal and Connective Tissue Disorders: joint stiffness, joint swelling, musculoskeletal chest pain, posture abnormal, myalgia, neck pain, muscular weakness, rhabdomyolysis

Nervous System Disorders: balance disorder, disturbance in attention, dysarthria, unresponsive to stimuli, depressed level of consciousness, movement disorder, transient ischemic attack, coordination abnormal, cerebrovascular accident, speech disorder, syncope, loss of consciousness, hypoesthesia, tardive dyskinesia, dyskinesia, cerebral ischemia, cerebrovascular disorder, neuroleptic malignant syndrome, diabetic coma, head titubation

Psychiatric Disorders: agitation, blunted affect, confusional state, middle insomnia, nervousness, sleep disorder, listlessness, libido decreased, and anorgasmia

Renal and Urinary Disorders: enuresis, dysuria, pollakiuria, urinary incontinence

Reproductive System and Breast Disorders: menstruation irregular, amenorrhea, gynecomastia, galactorrhea, vaginal discharge, menstrual disorder, erectile dysfunction, retrograde ejaculation, ejaculation disorder, sexual dysfunction, breast enlargement

Respiratory, Thoracic, and Mediastinal Disorders: wheezing, pneumonia aspiration, sinus congestion, dysphonia, productive cough, pulmonary congestion, respiratory tract congestion, rales, respiratory disorder, hyperventilation, nasal edema

Skin and Subcutaneous Tissue Disorders: erythema, skin discoloration, skin lesion, pruritus, skin disorder, rash erythematous, rash papular, rash generalized, rash maculopapular, acne, hyperkeratosis, seborrheic dermatitis

Vascular Disorders: hypotension, flushing

Additional Adverse Reactions Reported with RISPERDAL® CONSTA®

The following is a list of additional adverse reactions that have been reported during the premarketing evaluation of RISPERDAL® CONSTA®, regardless of frequency of occurrence:

Cardiac Disorders: bradycardia

Ear and Labyrinth Disorders: vertigo

Eye Disorders: blepharospasm

Gastrointestinal Disorders: toothache, tongue spasm

General Disorders and Administration Site Conditions: pain

Infections and Infestations: lower respiratory tract infection, infection, gastroenteritis, subcutaneous abscess

Injury and Poisoning: fall

Investigations: weight decreased, gamma-glutamyltransferase increased, hepatic enzyme increased

Musculoskeletal, Connective Tissue, and Bone Disorders: buttock pain

Nervous System Disorders: convulsion, paresthesia

Psychiatric Disorders: depression

Skin and Subcutaneous Tissue Disorders: eczema

Vascular Disorders: hypertension

Discontinuations Due to Adverse Reactions

Schizophrenia - Adults

Approximately 7% (39/564) of RISPERDAL[®]-treated patients in double-blind, placebo-controlled trials discontinued treatment due to an adverse reaction, compared with 4% (10/225) who were receiving placebo. The adverse reactions associated with discontinuation in 2 or more RISPERDAL[®]-treated patients were:

Table 14. Adverse Reactions Associated With Discontinuation in 2 or More RISPERDAL[®]-Treated Adult Patients in Schizophrenia Trials

Adverse Reaction	RISPERDAL [®]		Placebo (N=225)
	2-8 mg/day (N=366)	>8-16 mg/day (N=198)	
Dizziness	1.4%	1.0%	0%
Nausea	1.4%	0%	0%
Vomiting	0.8%	0%	0%
Parkinsonism	0.8%	0%	0%
Somnolence	0.8%	0%	0%
Dystonia	0.5%	0%	0%
Agitation	0.5%	0%	0%
Abdominal pain	0.5%	0%	0%
Orthostatic hypotension	0.3%	0.5%	0%
Akathisia	0.3%	2.0%	0%

Discontinuation for extrapyramidal symptoms (including Parkinsonism, akathisia, dystonia, and tardive dyskinesia) was 1% in placebo-treated patients, and 3.4% in active control-treated patients in a double-blind, placebo- and active-controlled trial.

Schizophrenia - Pediatrics

Approximately 7% (7/106), of RISPERDAL[®]-treated patients discontinued treatment due to an adverse reaction in a double-blind, placebo-controlled trial, compared with 4% (2/54) placebo-treated patients. The adverse reactions associated with discontinuation for at least one

RISPERDAL[®]-treated patient were dizziness (2%), somnolence (1%), sedation (1%), lethargy (1%), anxiety (1%), balance disorder (1%), hypotension (1%), and palpitation (1%).

Bipolar Mania - Adults

In double-blind, placebo-controlled trials with RISPERDAL[®] as monotherapy, approximately 6% (25/448) of RISPERDAL[®]-treated patients discontinued treatment due to an adverse event, compared with approximately 5% (19/424) of placebo-treated patients. The adverse reactions associated with discontinuation in RISPERDAL[®]-treated patients were:

Table 15. Adverse Reactions Associated With Discontinuation in 2 or More RISPERDAL[®]-Treated Adult Patients in Bipolar Mania Clinical Trials

Adverse Reaction	RISPERDAL [®]	
	1-6 mg/day (N=448)	Placebo (N=424)
Parkinsonism	0.4%	0%
Lethargy	0.2%	0%
Dizziness	0.2%	0%
Alanine aminotransferase increased	0.2%	0.2%
Aspartate aminotransferase increased	0.2%	0.2%

Bipolar Mania - Pediatrics

In a double-blind, placebo-controlled trial 12% (13/111) of RISPERDAL[®]-treated patients discontinued due to an adverse reaction, compared with 7% (4/58) of placebo-treated patients. The adverse reactions associated with discontinuation in more than one RISPERDAL[®]-treated pediatric patient were nausea (3%), somnolence (2%), sedation (2%), and vomiting (2%).

Autistic Disorder - Pediatrics

In the two 8-week, placebo-controlled trials in pediatric patients treated for irritability associated with autistic disorder (n = 156), one RISPERDAL[®]-treated patient discontinued due to an adverse reaction (Parkinsonism), and one placebo-treated patient discontinued due to an adverse event.

Dose Dependency of Adverse Reactions in Clinical Trials

Extrapyramidal Symptoms

Data from two fixed-dose trials in adults with schizophrenia provided evidence of dose-relatedness for extrapyramidal symptoms associated with RISPERDAL[®] treatment.

Two methods were used to measure extrapyramidal symptoms (EPS) in an 8-week trial comparing 4 fixed doses of RISPERDAL[®] (2, 6, 10, and 16 mg/day), including (1) a Parkinsonism score (mean change from baseline) from the Extrapyramidal Symptom Rating Scale, and (2) incidence of spontaneous complaints of EPS:

Table 16.

Dose Groups	Placebo	RISPERDAL [®] 2 mg	RISPERDAL [®] 6 mg	RISPERDAL [®] 10 mg	RISPERDAL [®] 16 mg
Parkinsonism	1.2	0.9	1.8	2.4	2.6
EPS Incidence	13%	17%	21%	21%	35%

Similar methods were used to measure extrapyramidal symptoms (EPS) in an 8-week trial comparing 5 fixed doses of RISPERDAL[®] (1, 4, 8, 12, and 16 mg/day):

Table 17.

Dose Groups	RISPERDAL [®] 1 mg	RISPERDAL [®] 4 mg	RISPERDAL [®] 8 mg	RISPERDAL [®] 12 mg	RISPERDAL [®] 16 mg
Parkinsonism	0.6	1.7	2.4	2.9	4.1
EPS Incidence	7%	12%	17%	18%	20%

Dystonia

Class Effect: Symptoms of dystonia, prolonged abnormal contractions of muscle groups, may occur in susceptible individuals during the first few days of treatment. Dystonic symptoms include: spasm of the neck muscles, sometimes progressing to tightness of the throat, swallowing difficulty, difficulty breathing, and/or protrusion of the tongue. While these symptoms can occur at low doses, they occur more frequently and with greater severity with high potency and at higher doses of first generation antipsychotic drugs. An elevated risk of acute dystonia is observed in males and younger age groups.

Other Adverse Reactions

Adverse event data elicited by a checklist for side effects from a large study comparing 5 fixed doses of RISPERDAL[®] (1, 4, 8, 12, and 16 mg/day) were explored for dose-relatedness of adverse events. A Cochran-Armitage Test for trend in these data revealed a positive trend ($p < 0.05$) for the following adverse reactions: somnolence, vision abnormal, dizziness, palpitations, weight increase, erectile dysfunction, ejaculation disorder, sexual function abnormal, fatigue, and skin discoloration.

Changes in Body Weight

Weight gain was observed in short-term, controlled trials and longer-term uncontrolled studies in adult and pediatric patients [see *Warnings and Precautions (5.5)*, *Adverse Reactions (6)*, and *Use in Specific Populations (8.4)*].

Changes in ECG Parameters

Between-group comparisons for pooled placebo-controlled trials in adults revealed no statistically significant differences between risperidone and placebo in mean changes from baseline in ECG parameters, including QT, QTc, and PR intervals, and heart rate. When all RISPERDAL[®] doses were pooled from randomized controlled trials in several indications, there was a mean increase in heart rate of 1 beat per minute compared to no change for placebo patients. In short-term schizophrenia trials, higher doses of risperidone (8-16 mg/day) were associated with a higher mean increase in heart rate compared to placebo (4-6 beats per minute). In pooled placebo-controlled acute mania trials in adults, there were small decreases in mean heart rate, similar among all treatment groups.

In the two placebo-controlled trials in children and adolescents with autistic disorder (aged 5 - 16 years) mean changes in heart rate were an increase of 8.4 beats per minute in the RISPERDAL[®] groups and 6.5 beats per minute in the placebo group. There were no other notable ECG changes.

In a placebo-controlled acute mania trial in children and adolescents (aged 10 – 17 years), there were no significant changes in ECG parameters, other than the effect of RISPERDAL[®] to transiently increase pulse rate (< 6 beats per minute). In two controlled schizophrenia trials in adolescents (aged 13 – 17 years), there were no clinically meaningful changes in ECG parameters including corrected QT intervals between treatment groups or within treatment groups over time.

6.2 Postmarketing Experience

The following adverse reactions have been identified during postapproval use of risperidone. Because these reactions are reported voluntarily from a population of uncertain size, it is not always possible to reliably estimate their frequency or establish a causal relationship to drug exposure. These adverse reactions include: alopecia, anaphylactic reaction, angioedema, atrial fibrillation, cardiopulmonary arrest, diabetic ketoacidosis in patients with impaired glucose metabolism, dysgeusia, hypoglycemia, hypothermia, ileus, inappropriate antidiuretic hormone secretion, intestinal obstruction, jaundice, mania, pancreatitis, pituitary adenoma, precocious puberty, pulmonary embolism, QT prolongation, sleep apnea syndrome, sudden death, thrombocytopenia, thrombotic thrombocytopenic purpura, urinary retention, and water intoxication.

7 DRUG INTERACTIONS

7.1 Pharmacokinetic-related Interactions

The dose of RISPARDAL[®] should be adjusted when used in combination with CYP2D6 enzyme inhibitors (e.g., fluoxetine, and paroxetine) and enzyme inducers (e.g., carbamazepine) [see Table 18 and Dosage and Administration (2.5)]. Dose adjustment is not recommended for RISPARDAL[®] when co-administered with ranitidine, cimetidine, amitriptyline, or erythromycin [see Table 18].

Table 18 Summary of Effect of Coadministered Drugs on Exposure to Active Moiety (Risperidone + 9-Hydroxy-Risperidone) in Healthy Subjects or Patients with Schizophrenia

Coadministered Drug	Dosing Schedule		Effect on Active Moiety (Risperidone + 9-Hydroxy-Risperidone (Ratio*))		Risperidone Dose Recommendation
	Coadministered Drug	Risperidone	AUC	Cmax	
Enzyme (CYP2D6) Inhibitors					
Fluoxetine	20 mg/day	2 or 3 mg twice daily	1.4	1.5	Re-evaluate dosing. Do not exceed 8 mg/day
Paroxetine	10 mg/day	4 mg/day	1.3	-	Re-evaluate dosing. Do not exceed 8 mg/day
	20 mg/day	4 mg/day	1.6	-	
	40 mg/day	4 mg/day	1.8	-	
Enzyme (CYP3A/PgP inducers) Inducers					
Carbamazepine	573 ± 168 mg/day	3 mg twice daily	0.51	0.55	Titrate dose upwards. Do not exceed twice the patient's usual dose
Enzyme (CYP3A) Inhibitors					
Ranitidine	150 mg twice daily	1 mg single dose	1.2	1.4	Dose adjustment not needed
Cimetidine	400 mg twice daily	1 mg single dose	1.1	1.3	Dose adjustment not needed
Erythromycin	500 mg four times daily	1 mg single dose	1.1	0.94	Dose adjustment not needed
Other Drugs					
Amitriptyline	50 mg twice daily	3 mg twice daily	1.2	1.1	Dose adjustment not needed

*Change relative to reference

Effect of Risperidone on other drugs

Lithium

Repeated oral doses of RISPERDAL[®] (3 mg twice daily) did not affect the exposure (AUC) or peak plasma concentrations (C_{max}) of lithium (n=13). Dose adjustment for lithium is not recommended.

Valproate

Repeated oral doses of RISPERDAL[®] (4 mg once daily) did not affect the pre-dose or average plasma concentrations and exposure (AUC) of valproate (1000 mg/day in three divided doses) compared to placebo (n=21). However, there was a 20% increase in valproate peak plasma concentration (C_{max}) after concomitant administration of RISPERDAL[®]. Dose adjustment for valproate is not recommended.

Digoxin

RISPERDAL[®] (0.25 mg twice daily) did not show a clinically relevant effect on the pharmacokinetics of digoxin. Dose adjustment for digoxin is not recommended.

7.2 Pharmacodynamic-related Interactions

Centrally-Acting Drugs and Alcohol

Given the primary CNS effects of risperidone, caution should be used when RISPERDAL[®] is taken in combination with other centrally-acting drugs and alcohol.

Drugs with Hypotensive Effects

Because of its potential for inducing hypotension, RISPERDAL[®] may enhance the hypotensive effects of other therapeutic agents with this potential.

Levodopa and Dopamine Agonists

RISPERDAL[®] may antagonize the effects of levodopa and dopamine agonists.

Clozapine

Chronic administration of clozapine with RISPERDAL[®] may decrease the clearance of risperidone.

8 USE IN SPECIFIC POPULATIONS

8.1 Pregnancy

Pregnancy Category C

Risk Summary

Adequate and well controlled studies with RISPERDAL have not been conducted in pregnant women. Neonates exposed to antipsychotic drugs (including RISPERDAL[®]) during the third trimester of pregnancy are at risk for extrapyramidal and/or withdrawal symptoms following

delivery. There was no increase in the incidence of malformations in embryo-fetal studies in rats and rabbits at 0.4–6 times MHRD. Increased pup mortality was noted at all doses in peripostnatal studies in rats. RISPERDAL[®] should be used during pregnancy only if the potential benefit justifies the potential risk to the fetus.

Clinical Considerations

Fetal/Neonatal Adverse Reactions

Monitor neonates exhibiting extrapyramidal or withdrawal symptoms. Some neonates recover within hours or days without specific treatment; others may require prolonged hospitalization.

Data

Human Data

There have been reports of agitation, hypertonia, hypotonia, tremor, somnolence, respiratory distress, and feeding disorder in neonates following in utero exposure to antipsychotics in the third trimester. These complications have varied in severity; while in some cases symptoms have been self-limited, in other cases neonates have required intensive care unit support and prolonged hospitalization.

There was one report of a case of agenesis of the corpus callosum in an infant exposed to risperidone *in utero*. The causal relationship to RISPERDAL[®] therapy is unknown.

Animal Data

The teratogenic potential of risperidone was studied in three Segment II studies in Sprague-Dawley and Wistar rats (0.63-10 mg/kg or 0.4 to 6 times the maximum recommended human dose [MRHD] on a mg/m² body surface area basis) and in one Segment II study in New Zealand rabbits (0.31-5 mg/kg or 0.4 to 6 times the MRHD on a mg/m² body surface area basis). There were no teratogenic effects in offspring of rats or rabbits given 0.4 to 6 times the MRHD on a mg/m² body surface area basis. In three reproductive studies in rats (two Segment III and a multigenerational study), there was an increase in pup deaths during the first 4 days of lactation at doses of 0.16-5 mg/kg or 0.1 to 3 times the MRHD on a mg/m² body surface area basis. It is not known whether these deaths were due to a direct effect on the fetuses or pups or to effects on the dams.

There was no no-effect dose for increased rat pup mortality. In one Segment III study, there was an increase in stillborn rat pups at a dose of 2.5 mg/kg or 1.5 times the MRHD on a mg/m² body surface area basis. In a cross-fostering study in Wistar rats, toxic effects on the fetus or pups were observed, as evidenced by a decrease in the number of live pups and an increase in the

number of dead pups at birth (Day 0), and a decrease in birth weight in pups of drug-treated dams. In addition, there was an increase in deaths by Day 1 among pups of drug-treated dams, regardless of whether or not the pups were cross-fostered. Risperidone also appeared to impair maternal behavior in that pup body weight gain and survival (from Day 1 to 4 of lactation) were reduced in pups born to control but reared by drug-treated dams. These effects were all noted at the one dose of risperidone tested, i.e., 5 mg/kg or 3 times the MRHD on a mg/m² body surface area basis.

Placental transfer of risperidone occurs in rat pups.

8.2 Labor and Delivery

The effect of RISPERDAL[®] on labor and delivery in humans is unknown.

8.3 Nursing Mothers

Risperidone and 9-hydroxyrisperidone are present in human breast milk. Because of the potential for serious adverse reactions in nursing infants from risperidone, a decision should be made whether to discontinue nursing or to discontinue the drug, taking into account the importance of the drug to the mother.

8.4 Pediatric Use

Approved Pediatric Indications

Schizophrenia

The efficacy and safety of RISPERDAL[®] in the treatment of schizophrenia were demonstrated in 417 adolescents, aged 13 – 17 years, in two short-term (6 and 8 weeks, respectively) double-blind controlled trials [see *Indications and Usage (1.1)*, *Adverse Reactions (6.1)*, and *Clinical Studies (14.1)*]. Additional safety and efficacy information was also assessed in one long-term (6-month) open-label extension study in 284 of these adolescent patients with schizophrenia.

Safety and effectiveness of RISPERDAL[®] in children less than 13 years of age with schizophrenia have not been established.

Bipolar I Disorder

The efficacy and safety of RISPERDAL[®] in the short-term treatment of acute manic or mixed episodes associated with Bipolar I Disorder in 169 children and adolescent patients, aged 10 – 17 years, were demonstrated in one double-blind, placebo-controlled, 3-week trial [see *Indications and Usage (1.2)*, *Adverse Reactions (6.1)*, and *Clinical Studies (14.2)*].

Safety and effectiveness of RISPERDAL[®] in children less than 10 years of age with bipolar disorder have not been established.

Autistic Disorder

The efficacy and safety of RISPERDAL[®] in the treatment of irritability associated with autistic disorder were established in two 8-week, double-blind, placebo-controlled trials in 156 children and adolescent patients, aged 5 to 16 years [see *Indications and Usage (1.3)*, *Adverse Reactions (6.1)* and *Clinical Studies (14.4)*]. Additional safety information was also assessed in a long-term study in patients with autistic disorder, or in short- and long-term studies in more than 1200 pediatric patients with psychiatric disorders other than autistic disorder, schizophrenia, or bipolar mania who were of similar age and weight, and who received similar dosages of RISPERDAL[®] as patients treated for irritability associated with autistic disorder.

A third study was a 6-week, multicenter, randomized, double-blind, placebo-controlled, fixed-dose study to evaluate the efficacy and safety of a lower than recommended dose of risperidone in subjects 5 to 17 years of age with autistic disorder and associated irritability, and related behavioral symptoms. There were two weight-based, fixed doses of risperidone (high-dose and low-dose). The high dose was 1.25 mg per day for patients weighing 20 to < 45 kg, and it was 1.75 mg per day for patients weighing \geq 45 kg. The low dose was 0.125 mg per day for patients weighing 20 to < 45 kg, and it was 0.175 mg per day for patients weighing \geq 45 kg. The study demonstrated the efficacy of high-dose risperidone, but it did not demonstrate efficacy for low-dose risperidone.

Adverse Reactions in Pediatric Patients

Tardive Dyskinesia

In clinical trials in 1885 children and adolescents treated with RISPERDAL[®], 2 (0.1%) patients were reported to have tardive dyskinesia, which resolved on discontinuation of RISPERDAL[®] treatment [see also *Warnings and Precautions (5.4)*].

Weight Gain

Weight gain has been observed in children and adolescents during treatment with RISPERDAL[®]. Clinical monitoring of weight is recommended during treatment.

Data derive from short-term placebo-controlled trials and longer-term uncontrolled studies in pediatric patients (ages 5 to 17 years) with schizophrenia, bipolar disorder, autistic disorder, or other psychiatric disorders. In the short-term trials (3 to 8 weeks), the mean weight gain for RISPERDAL[®]-treated patients was 2 kg, compared to 0.6 kg for placebo-treated patients. In these trials, approximately 33% of the RISPERDAL[®] group had weight gain \geq 7%, compared to 7% in the placebo group. In longer-term, uncontrolled, open-label pediatric studies, the mean weight gain was 5.5 kg at Week 24 and 8 kg at Week 48 [see *Warnings and Precautions (5.5)* and *Adverse Reactions (6.1)*].

Somnolence

Somnolence was frequently observed in placebo-controlled clinical trials of pediatric patients with autistic disorder. Most cases were mild or moderate in severity. These events were most often of early onset with peak incidence occurring during the first two weeks of treatment, and transient with a median duration of 16 days. Somnolence was the most commonly observed adverse reaction in the clinical trial of bipolar disorder in children and adolescents, as well as in the schizophrenia trials in adolescents. As was seen in the autistic disorder trials, these adverse reactions were most often of early onset and transient in duration [see *Adverse Reactions (6.1 and 6.2)*]. Patients experiencing persistent somnolence may benefit from a change in dosing regimen [see *Dosage and Administration (2.1, 2.2, and 2.3)*].

Hyperprolactinemia

RISPERDAL[®] has been shown to elevate prolactin levels in children and adolescents as well as in adults [see *Warnings and Precautions (5.6)*]. In double-blind, placebo-controlled studies of up to 8 weeks duration in children and adolescents (aged 5 to 17 years) with autistic disorder or psychiatric disorders other than autistic disorder, schizophrenia, or bipolar mania, 49% of patients who received RISPERDAL[®] had elevated prolactin levels compared to 2% of patients who received placebo. Similarly, in placebo-controlled trials in children and adolescents (aged 10 to 17 years) with bipolar disorder, or adolescents (aged 13 to 17 years) with schizophrenia, 82–87% of patients who received RISPERDAL[®] had elevated levels of prolactin compared to 3–7% of patients on placebo. Increases were dose-dependent and generally greater in females than in males across indications.

In clinical trials in 1885 children and adolescents, galactorrhea was reported in 0.8% of RISPERDAL[®]-treated patients and gynecomastia was reported in 2.3% of RISPERDAL[®]-treated patients.

Growth and Sexual Maturation

The long-term effects of RISPERDAL[®] on growth and sexual maturation have not been fully evaluated in children and adolescents.

Juvenile Animal Studies

Juvenile dogs were treated for 40 weeks with oral risperidone doses of 0.31, 1.25, or 5 mg/kg/day. Decreased bone length and density were seen, with a no-effect dose of 0.31 mg/kg/day. This dose produced plasma levels (AUC) of risperidone plus its active metabolite paliperidone (9-hydroxy-risperidone) which were similar to those in children and adolescents receiving the maximum recommended human dose (MRHD) of 6 mg/day. In addition, a delay in sexual maturation was seen at all doses in both males and females. The above effects showed little or no reversibility in females after a 12 week drug-free recovery period.

In a study in which juvenile rats were treated with oral risperidone from days 12 to 50 of age, a reversible impairment of performance in a test of learning and memory was seen, in females only, with a no-effect dose of 0.63 mg/kg/day. This dose produced plasma levels (AUC) of risperidone plus paliperidone about half those observed in humans at the MRHD. No other consistent effects on neurobehavioral or reproductive development were seen up to the highest testable dose (1.25 mg/kg/day). This dose produced plasma levels (AUC) of risperidone plus paliperidone which were about two thirds of those observed in humans at the MRHD.

8.5 Geriatric Use

Clinical studies of RISPERDAL[®] in the treatment of schizophrenia did not include sufficient numbers of patients aged 65 and over to determine whether or not they respond differently than younger patients. Other reported clinical experience has not identified differences in responses between elderly and younger patients. In general, a lower starting dose is recommended for an elderly patient, reflecting a decreased pharmacokinetic clearance in the elderly, as well as a greater frequency of decreased hepatic, renal, or cardiac function, and of concomitant disease or other drug therapy [see *Clinical Pharmacology (12.3) and Dosage and Administration (2.4, 2.5)*]. While elderly patients exhibit a greater tendency to orthostatic hypotension, its risk in the elderly may be minimized by limiting the initial dose to 0.5 mg twice daily followed by careful titration [see *Warnings and Precautions (5.7)*]. Monitoring of orthostatic vital signs should be considered in patients for whom this is of concern.

This drug is substantially excreted by the kidneys, and the risk of toxic reactions to this drug may be greater in patients with impaired renal function. Because elderly patients are more likely to have decreased renal function, care should be taken in dose selection, and it may be useful to monitor renal function [see *Dosage and Administration (2.4)*].

8.6 Renal Impairment

In patients with moderate to severe (Cl_{cr} 59 to 15 mL/min) renal disease, clearance of the sum of risperidone and its active metabolite decreased by 60%, compared to young healthy subjects. RISPERDAL[®] doses should be reduced in patients with renal disease [see *Dosage and Administration (2.4)*].

8.7 Hepatic Impairment

While the pharmacokinetics of risperidone in subjects with liver disease were comparable to those in young healthy subjects, the mean free fraction of risperidone in plasma was increased by about 35% because of the diminished concentration of both albumin and α_1 -acid glycoprotein. RISPERDAL[®] doses should be reduced in patients with liver disease [*see Dosage and Administration (2.4)*].

8.8 Patients with Parkinson's Disease or Lewy Body Dementia

Patients with Parkinson's Disease or Dementia with Lewy Bodies can experience increased sensitivity to RISPERDAL[®]. Manifestations can include confusion, obtundation, postural instability with frequent falls, extrapyramidal symptoms, and clinical features consistent with neuroleptic malignant syndrome.

9 DRUG ABUSE AND DEPENDENCE

9.1 Controlled Substance

RISPERDAL[®] (risperidone) is not a controlled substance.

9.2 Abuse

RISPERDAL[®] has not been systematically studied in animals or humans for its potential for abuse. While the clinical trials did not reveal any tendency for any drug-seeking behavior, these observations were not systematic and it is not possible to predict on the basis of this limited experience the extent to which a CNS-active drug will be misused, diverted, and/or abused once marketed. Consequently, patients should be evaluated carefully for a history of drug abuse, and such patients should be observed closely for signs of RISPERDAL[®] misuse or abuse (e.g., development of tolerance, increases in dose, drug-seeking behavior).

9.3 Dependence

RISPERDAL[®] has not been systematically studied in animals or humans for its potential for tolerance or physical dependence.

10 OVERDOSAGE

10.1 Human Experience

Premarketing experience included eight reports of acute RISPERDAL[®] overdose with estimated doses ranging from 20 to 300 mg and no fatalities. In general, reported signs and symptoms were those resulting from an exaggeration of the drug's known pharmacological effects, i.e., drowsiness and sedation, tachycardia and hypotension, and extrapyramidal symptoms. One case, involving an estimated overdose of 240 mg, was associated with hyponatremia, hypokalemia, prolonged QT, and widened QRS. Another case, involving an estimated overdose of 36 mg, was associated with a seizure.

Postmarketing experience includes reports of acute RISPERDAL[®] overdose, with estimated doses of up to 360 mg. In general, the most frequently reported signs and symptoms are those resulting from an exaggeration of the drug's known pharmacological effects, i.e., drowsiness, sedation, tachycardia, hypotension, and extrapyramidal symptoms. Other adverse reactions reported since market introduction related to RISPERDAL[®] overdose include prolonged QT interval and convulsions. Torsade de pointes has been reported in association with combined overdose of RISPERDAL[®] and paroxetine.

10.2 Management of Overdosage

For the most up to date information on the management of RISPERDAL[®] overdose, contact a certified poison control center (1-800-222-1222 or www.poison.org). Provide supportive care including close medical supervision and monitoring. Treatment should consist of general measures employed in the management of overdose with any drug. Consider the possibility of multiple drug overdose. Ensure an adequate airway, oxygenation, and ventilation. Monitor cardiac rhythm and vital signs. Use supportive and symptomatic measures. There is no specific antidote to RISPERDAL[®].

11 DESCRIPTION

RISPERDAL[®] contains risperidone, an atypical antipsychotic belonging to the chemical class of benzisoxazole derivatives. The chemical designation is 3-[2-[4-(6-fluoro-1,2-benzisoxazol-3-yl)-1-piperidinyl]ethyl]-6,7,8,9-tetrahydro-2-methyl-4H-pyrido[1,2-a]pyrimidin-4-one. Its molecular formula is C₂₃H₂₇FN₄O₂ and its molecular weight is 410.49. The structural formula is:

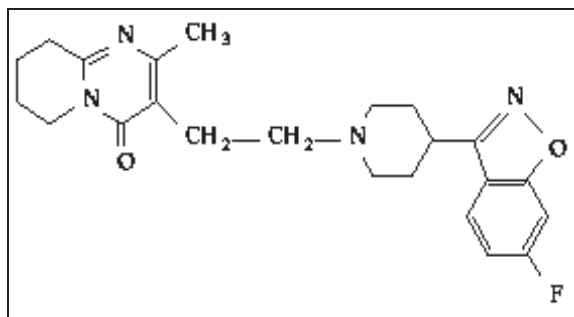

Risperidone is a white to slightly beige powder. It is practically insoluble in water, freely soluble in methylene chloride, and soluble in methanol and 0.1 N HCl.

RISPERDAL[®] Tablets are for oral administration and available in 0.25 mg (dark yellow), 0.5 mg (red-brown), 1 mg (white), 2 mg (orange), 3 mg (yellow), and 4 mg (green) strengths. RISPERDAL[®] tablets contain the following inactive ingredients: colloidal silicon dioxide, hypromellose, lactose, magnesium stearate, microcrystalline cellulose, propylene glycol, sodium lauryl sulfate, and starch (corn). The 0.25 mg, 0.5 mg, 2 mg, 3 mg, and 4 mg tablets also contain talc and titanium dioxide. The 0.25 mg tablets contain yellow iron oxide; the 0.5 mg tablets contain red iron oxide; the 2 mg tablets contain FD&C Yellow No. 6 Aluminum Lake; the 3 mg and 4 mg tablets contain D&C Yellow No. 10; the 4 mg tablets contain FD&C Blue No. 2 Aluminum Lake.

RISPERDAL[®] is also available as a 1 mg/mL oral solution. RISPERDAL[®] Oral Solution contains the following inactive ingredients: tartaric acid, benzoic acid, sodium hydroxide, and purified water.

RISPERDAL[®] M-TAB[®] Orally Disintegrating Tablets are available in 0.5 mg (light coral), 1 mg (light coral), 2 mg (coral), 3 mg (coral), and 4 mg (coral) strengths. RISPERDAL[®] M-TAB[®] Orally Disintegrating Tablets contain the following inactive ingredients: Amberlite[®] resin, gelatin, mannitol, glycine, simethicone, carbomer, sodium hydroxide, aspartame, red ferric oxide, and peppermint oil. In addition, the 2 mg, 3 mg, and 4 mg RISPERDAL[®] M-TAB[®] Orally Disintegrating Tablets contain xanthan gum.

12 CLINICAL PHARMACOLOGY

12.1 Mechanism of Action

The mechanism of action of RISPERDAL[®], in schizophrenia, is unknown. However, it has been proposed that the drug's therapeutic activity in schizophrenia could be mediated through a combination of dopamine Type 2 (D₂) and serotonin Type 2 (5HT₂) receptor antagonism. The clinical effect from RISPERDAL[®] results from the combined concentrations of risperidone and

its major metabolite, 9-hydroxyrisperidone [see *Clinical Pharmacology (12.3)*]. Antagonism at receptors other than D₂ and 5HT₂ [see *Clinical Pharmacology (12.1)*] may explain some of the other effects of RISPERDAL[®].

12.2 Pharmacodynamics

RISPERDAL[®] is a selective monoaminergic antagonist with high affinity (K_i of 0.12 to 7.3 nM) for the serotonin Type 2 (5HT₂), dopamine Type 2 (D₂), α₁ and α₂ adrenergic, and H₁ histaminergic receptors. RISPERDAL[®] acts as an antagonist at other receptors, but with lower potency. RISPERDAL[®] has low to moderate affinity (K_i of 47 to 253 nM) for the serotonin 5HT_{1C}, 5HT_{1D}, and 5HT_{1A} receptors, weak affinity (K_i of 620 to 800 nM) for the dopamine D₁ and haloperidol-sensitive sigma site, and no affinity (when tested at concentrations >10⁻⁵ M) for cholinergic muscarinic or β₁ and β₂ adrenergic receptors.

12.3 Pharmacokinetics

Absorption

Risperidone is well absorbed. The absolute oral bioavailability of risperidone is 70% (CV=25%). The relative oral bioavailability of risperidone from a tablet is 94% (CV=10%) when compared to a solution.

Pharmacokinetic studies showed that RISPERDAL[®] M-TAB[®] Orally Disintegrating Tablets and RISPERDAL[®] Oral Solution are bioequivalent to RISPERDAL[®] Tablets.

Plasma concentrations of risperidone, its major metabolite, 9-hydroxyrisperidone, and risperidone plus 9-hydroxyrisperidone are dose proportional over the dosing range of 1 to 16 mg daily (0.5 to 8 mg twice daily). Following oral administration of solution or tablet, mean peak plasma concentrations of risperidone occurred at about 1 hour. Peak concentrations of 9-hydroxyrisperidone occurred at about 3 hours in extensive metabolizers, and 17 hours in poor metabolizers. Steady-state concentrations of risperidone are reached in 1 day in extensive metabolizers and would be expected to reach steady-state in about 5 days in poor metabolizers. Steady-state concentrations of 9-hydroxyrisperidone are reached in 5-6 days (measured in extensive metabolizers).

Food Effect

Food does not affect either the rate or extent of absorption of risperidone. Thus, RISPERDAL[®] can be given with or without meals.

Distribution

Risperidone is rapidly distributed. The volume of distribution is 1-2 L/kg. In plasma, risperidone is bound to albumin and α₁-acid glycoprotein. The plasma protein binding of risperidone is

90%, and that of its major metabolite, 9-hydroxyrisperidone, is 77%. Neither risperidone nor 9-hydroxyrisperidone displaces each other from plasma binding sites. High therapeutic concentrations of sulfamethazine (100 mcg/mL), warfarin (10 mcg/mL), and carbamazepine (10mcg/mL) caused only a slight increase in the free fraction of risperidone at 10 ng/mL and 9-hydroxyrisperidone at 50 ng/mL, changes of unknown clinical significance.

Metabolism

Risperidone is extensively metabolized in the liver. The main metabolic pathway is through hydroxylation of risperidone to 9-hydroxyrisperidone by the enzyme, CYP 2D6. A minor metabolic pathway is through *N*-dealkylation. The main metabolite, 9-hydroxyrisperidone, has similar pharmacological activity as risperidone. Consequently, the clinical effect of the drug results from the combined concentrations of risperidone plus 9-hydroxyrisperidone.

CYP 2D6, also called debrisoquin hydroxylase, is the enzyme responsible for metabolism of many neuroleptics, antidepressants, antiarrhythmics, and other drugs. CYP 2D6 is subject to genetic polymorphism (about 6%-8% of Caucasians, and a very low percentage of Asians, have little or no activity and are “poor metabolizers”) and to inhibition by a variety of substrates and some non-substrates, notably quinidine. Extensive CYP 2D6 metabolizers convert risperidone rapidly into 9-hydroxyrisperidone, whereas poor CYP 2D6 metabolizers convert it much more slowly. Although extensive metabolizers have lower risperidone and higher 9-hydroxyrisperidone concentrations than poor metabolizers, the pharmacokinetics of risperidone and 9-hydroxyrisperidone combined, after single and multiple doses, are similar in extensive and poor metabolizers.

Risperidone could be subject to two kinds of drug-drug interactions. First, inhibitors of CYP 2D6 interfere with conversion of risperidone to 9-hydroxyrisperidone [*see Drug Interactions (7)*]. This occurs with quinidine, giving essentially all recipients a risperidone pharmacokinetic profile typical of poor metabolizers. The therapeutic benefits and adverse effects of risperidone in patients receiving quinidine have not been evaluated, but observations in a modest number ($n \approx 70$) of poor metabolizers given RISPERDAL[®] do not suggest important differences between poor and extensive metabolizers. Second, co-administration of known enzyme inducers (e.g., carbamazepine, phenytoin, rifampin, and phenobarbital) with RISPERDAL[®] may cause a decrease in the combined plasma concentrations of risperidone and 9-hydroxyrisperidone [*see Drug Interactions (7)*]. It would also be possible for risperidone to interfere with metabolism of other drugs metabolized by CYP 2D6. Relatively weak binding of risperidone to the enzyme suggests this is unlikely [*see Drug Interactions (7)*].

In vitro studies indicate that risperidone is a relatively weak inhibitor of CYP 2D6. Therefore, RISPERDAL[®] is not expected to substantially inhibit the clearance of drugs that are metabolized

by this enzymatic pathway. In drug interaction studies, RISPERDAL[®] did not significantly affect the pharmacokinetics of donepezil and galantamine, which are metabolized by CYP 2D6.

In vitro studies demonstrated that drugs metabolized by other CYP isozymes, including 1A1, 1A2, 2C9, 2C19, and 3A4, are only weak inhibitors of risperidone metabolism.

Excretion

Risperidone and its metabolites are eliminated via the urine and, to a much lesser extent, via the feces. As illustrated by a mass balance study of a single 1 mg oral dose of ¹⁴C-risperidone administered as solution to three healthy male volunteers, total recovery of radioactivity at 1 week was 84%, including 70% in the urine and 14% in the feces.

The apparent half-life of risperidone was 3 hours (CV=30%) in extensive metabolizers and 20 hours (CV=40%) in poor metabolizers. The apparent half-life of 9-hydroxyrisperidone was about 21 hours (CV=20%) in extensive metabolizers and 30 hours (CV=25%) in poor metabolizers. The pharmacokinetics of risperidone and 9-hydroxyrisperidone combined, after single and multiple doses, were similar in extensive and poor metabolizers, with an overall mean elimination half-life of about 20 hours.

Drug-Drug Interaction Studies

[See Drug Interactions (7)].

Specific Populations

Renal and Hepatic Impairment

[See Use in Specific Populations (8.6 and 8.7)].

Elderly

In healthy elderly subjects, renal clearance of both risperidone and 9-hydroxyrisperidone was decreased, and elimination half-lives were prolonged compared to young healthy subjects. Dosing should be modified accordingly in the elderly patients *[see Use in Specific Populations (8.5)]*.

Pediatric

The pharmacokinetics of risperidone and 9-hydroxyrisperidone in children were similar to those in adults after correcting for the difference in body weight.

Race and Gender Effects

No specific pharmacokinetic study was conducted to investigate race and gender effects, but a population pharmacokinetic analysis did not identify important differences in the disposition of risperidone due to gender (whether corrected for body weight or not) or race.

13 NONCLINICAL TOXICOLOGY

13.1 Carcinogenesis, Mutagenesis, Impairment of Fertility

Carcinogenesis

Carcinogenicity studies were conducted in Swiss albino mice and Wistar rats. Risperidone was administered in the diet at doses of 0.63 mg/kg, 2.5 mg/kg, and 10 mg/kg for 18 months to mice and for 25 months to rats. These doses are equivalent to approximately 2, 9, and 38 times the maximum recommended human dose (MRHD) for schizophrenia of 16 mg/day on a mg/kg basis or 0.2, 0.75, and 3 times the MRHD (mice) or 0.4, 1.5, and 6 times the MRHD (rats) on a mg/m² body surface basis. A maximum tolerated dose was not achieved in male mice. There were statistically significant increases in pituitary gland adenomas, endocrine pancreas adenomas, and mammary gland adenocarcinomas. The table below summarizes the multiples of the human dose on a mg/m² (mg/kg) basis at which these tumors occurred.

Tumor Type	Species	Sex	Multiples of Maximum Human Dose in mg/m ² (mg/kg)	
			Lowest Effect Level	Highest No-Effect Level
Pituitary adenomas	mouse	female	0.75 (9.4)	0.2 (2.4)
Endocrine pancreas adenomas	rat	male	1.5 (9.4)	0.4 (2.4)
Mammary gland adenocarcinomas	mouse	female	0.2 (2.4)	none
	rat	female	0.4 (2.4)	none
	rat	male	6.0 (37.5)	1.5 (9.4)
Mammary gland neoplasm, Total	rat	male	1.5 (9.4)	0.4 (2.4)

Antipsychotic drugs have been shown to chronically elevate prolactin levels in rodents. Serum prolactin levels were not measured during the risperidone carcinogenicity studies; however, measurements during subchronic toxicity studies showed that risperidone elevated serum prolactin levels 5-6 fold in mice and rats at the same doses used in the carcinogenicity studies. An increase in mammary, pituitary, and endocrine pancreas neoplasms has been found in rodents after chronic administration of other antipsychotic drugs and is considered to be prolactin-mediated. The relevance for human risk of the findings of prolactin-mediated endocrine tumors in rodents is unknown [see *Warnings and Precautions (5.6)*].

Mutagenesis

No evidence of mutagenic or clastogenic potential for risperidone was found in the Ames gene mutation test, the mouse lymphoma assay, the *in vitro* rat hepatocyte DNA-repair assay, the *in vivo* micronucleus test in mice, the sex-linked recessive lethal test in *Drosophila*, or the chromosomal aberration test in human lymphocytes or Chinese hamster ovary cells.

Impairment of Fertility

Risperidone (0.16 to 5 mg/kg) was shown to impair mating, but not fertility, in Wistar rats in three reproductive studies (two Segment I and a multigenerational study) at doses 0.1 to 3 times the maximum recommended human dose (MRHD) on a mg/m² body surface area basis. The effect appeared to be in females, since impaired mating behavior was not noted in the Segment I study in which males only were treated. In a subchronic study in Beagle dogs in which risperidone was administered orally at doses of 0.31 to 5 mg/kg, sperm motility and concentration were decreased at doses 0.6 to 10 times the MRHD on a mg/m² body surface area basis. Dose-related decreases were also noted in serum testosterone at the same doses. Serum testosterone and sperm parameters partially recovered, but remained decreased after treatment was discontinued. A no-effect dose could not be determined in either rat or dog.

13.2 Animal Toxicology

Juvenile dogs were treated for 40 weeks with oral risperidone doses of 0.31, 1.25, or 5 mg/kg/day. Decreased bone length and density were observed with a no-effect dose of 0.31 mg/kg/day. This dose produced plasma AUC levels of risperidone plus its active metabolite paliperidone (9-hydroxy-risperidone) which were similar to those in children and adolescents receiving the maximum recommended human dose (MRHD) of 6 mg/day. In addition, a delay in sexual maturation was seen at all doses in both males and females. The above effects showed little or no reversibility in females after a 12 week drug-free recovery period.

In a study in which juvenile rats were treated with oral risperidone from days 12 to 50 of age, a reversible impairment of performance in a test of learning and memory was observed in females only with a no-effect dose of 0.63 mg/kg/day. This dose produced plasma AUC levels of risperidone plus paliperidone about half those observed in humans at the MRHD. No other consistent effects on neurobehavioral or reproductive development were seen up to the highest testable dose of 1.25 mg/kg/day. This dose produced plasma AUC levels of risperidone plus paliperidone which were about two thirds of those observed in humans at the MRHD.

14 CLINICAL STUDIES

14.1 Schizophrenia

Adults

Short-Term Efficacy

The efficacy of RISPERDAL[®] in the treatment of schizophrenia was established in four short-term (4- to 8-week) controlled trials of psychotic inpatients who met DSM-III-R criteria for schizophrenia.

Several instruments were used for assessing psychiatric signs and symptoms in these studies, among them the Brief Psychiatric Rating Scale (BPRS), a multi-item inventory of general psychopathology traditionally used to evaluate the effects of drug treatment in schizophrenia. The BPRS psychosis cluster (conceptual disorganization, hallucinatory behavior, suspiciousness, and unusual thought content) is considered a particularly useful subset for assessing actively psychotic schizophrenic patients. A second traditional assessment, the Clinical Global Impression (CGI), reflects the impression of a skilled observer, fully familiar with the manifestations of schizophrenia, about the overall clinical state of the patient. In addition, the Positive and Negative Syndrome Scale (PANSS) and the Scale for Assessing Negative Symptoms (SANS) were employed.

The results of the trials follow:

- (1) In a 6-week, placebo-controlled trial (n=160) involving titration of RISPERDAL[®] in doses up to 10 mg/day (twice-daily schedule), RISPERDAL[®] was generally superior to placebo on the BPRS total score, on the BPRS psychosis cluster, and marginally superior to placebo on the SANS.
- (2) In an 8-week, placebo-controlled trial (n=513) involving 4 fixed doses of RISPERDAL[®] (2 mg/day, 6 mg/day, 10 mg/day, and 16 mg/day, on a twice-daily schedule), all 4 RISPERDAL[®] groups were generally superior to placebo on the BPRS total score, BPRS psychosis cluster, and CGI severity score; the 3 highest RISPERDAL[®] dose groups were generally superior to placebo on the PANSS negative subscale. The most consistently positive responses on all measures were seen for the 6 mg dose group, and there was no suggestion of increased benefit from larger doses.
- (3) In an 8-week, dose comparison trial (n=1356) involving 5 fixed doses of RISPERDAL[®] (1 mg/day, 4 mg/day, 8 mg/day, 12 mg/day, and 16 mg/day, on a twice-daily schedule), the four highest RISPERDAL[®] dose groups were generally superior to the 1 mg RISPERDAL[®] dose group on BPRS total score, BPRS psychosis cluster, and CGI severity score. None

of the dose groups were superior to the 1 mg group on the PANSS negative subscale. The most consistently positive responses were seen for the 4 mg dose group.

- (4) In a 4-week, placebo-controlled dose comparison trial (n=246) involving 2 fixed doses of RISPERDAL[®] (4 and 8 mg/day on a once-daily schedule), both RISPERDAL[®] dose groups were generally superior to placebo on several PANSS measures, including a response measure (>20% reduction in PANSS total score), PANSS total score, and the BPRS psychosis cluster (derived from PANSS). The results were generally stronger for the 8 mg than for the 4 mg dose group.

Long-Term Efficacy

In a longer-term trial, 365 adult outpatients predominantly meeting DSM-IV criteria for schizophrenia and who had been clinically stable for at least 4 weeks on an antipsychotic medication were randomized to RISPERDAL[®] (2-8 mg/day) or to an active comparator, for 1 to 2 years of observation for relapse. Patients receiving RISPERDAL[®] experienced a significantly longer time to relapse over this time period compared to those receiving the active comparator.

Pediatrics

The efficacy of RISPERDAL[®] in the treatment of schizophrenia in adolescents aged 13–17 years was demonstrated in two short-term (6 and 8 weeks), double-blind controlled trials. All patients met DSM-IV diagnostic criteria for schizophrenia and were experiencing an acute episode at time of enrollment. In the first trial (study #1), patients were randomized into one of three treatment groups: RISPERDAL[®] 1-3 mg/day (n = 55, mean modal dose = 2.6 mg), RISPERDAL[®] 4-6 mg/day (n = 51, mean modal dose = 5.3 mg), or placebo (n = 54). In the second trial (study #2), patients were randomized to either RISPERDAL[®] 0.15-0.6 mg/day (n = 132, mean modal dose = 0.5 mg) or RISPERDAL[®] 1.5–6 mg/day (n = 125, mean modal dose = 4 mg). In all cases, study medication was initiated at 0.5 mg/day (with the exception of the 0.15-0.6 mg/day group in study #2, where the initial dose was 0.05 mg/day) and titrated to the target dosage range by approximately Day 7. Subsequently, dosage was increased to the maximum tolerated dose within the target dose range by Day 14. The primary efficacy variable in all studies was the mean change from baseline in total PANSS score.

Results of the studies demonstrated efficacy of RISPERDAL[®] in all dose groups from 1-6 mg/day compared to placebo, as measured by significant reduction of total PANSS score. The efficacy on the primary parameter in the 1-3 mg/day group was comparable to the 4-6 mg/day group in study #1, and similar to the efficacy demonstrated in the 1.5–6 mg/day group in study #2. In study #2, the efficacy in the 1.5-6 mg/day group was statistically

significantly greater than that in the 0.15-0.6 mg/day group. Doses higher than 3 mg/day did not reveal any trend towards greater efficacy.

14.2 Bipolar Mania - Monotherapy

Adults

The efficacy of RISPERDAL[®] in the treatment of acute manic or mixed episodes was established in two short-term (3-week) placebo-controlled trials in patients who met the DSM-IV criteria for Bipolar I Disorder with manic or mixed episodes. These trials included patients with or without psychotic features.

The primary rating instrument used for assessing manic symptoms in these trials was the Young Mania Rating Scale (YMRS), an 11-item clinician-rated scale traditionally used to assess the degree of manic symptomatology (irritability, disruptive/aggressive behavior, sleep, elevated mood, speech, increased activity, sexual interest, language/thought disorder, thought content, appearance, and insight) in a range from 0 (no manic features) to 60 (maximum score). The primary outcome in these trials was change from baseline in the YMRS total score. The results of the trials follow:

- (1) In one 3-week placebo-controlled trial (n=246), limited to patients with manic episodes, which involved a dose range of RISPERDAL[®] 1-6 mg/day, once daily, starting at 3 mg/day (mean modal dose was 4.1 mg/day), RISPERDAL[®] was superior to placebo in the reduction of YMRS total score.
- (2) In another 3-week placebo-controlled trial (n=286), which involved a dose range of 1-6 mg/day, once daily, starting at 3 mg/day (mean modal dose was 5.6 mg/day), RISPERDAL[®] was superior to placebo in the reduction of YMRS total score.

Pediatrics

The efficacy of RISPERDAL[®] in the treatment of mania in children or adolescents with Bipolar I disorder was demonstrated in a 3-week, randomized, double-blind, placebo-controlled, multicenter trial including patients ranging in ages from 10 to 17 years who were experiencing a manic or mixed episode of bipolar I disorder. Patients were randomized into one of three treatment groups: RISPERDAL[®] 0.5-2.5 mg/day (n = 50, mean modal dose = 1.9 mg), RISPERDAL[®] 3-6 mg/day (n = 61, mean modal dose = 4.7 mg), or placebo (n = 58). In all cases, study medication was initiated at 0.5 mg/day and titrated to the target dosage range by Day 7, with further increases in dosage to the maximum tolerated dose within the targeted dose range by Day 10. The primary rating instrument used for assessing efficacy in this study was the mean change from baseline in the total YMRS score.

Results of this study demonstrated efficacy of RISPERDAL[®] in both dose groups compared with placebo, as measured by significant reduction of total YMRS score. The efficacy on the primary parameter in the 3-6 mg/day dose group was comparable to the 0.5-2.5 mg/day dose group. Doses higher than 2.5 mg/day did not reveal any trend towards greater efficacy.

14.3 Bipolar Mania – Adjunctive Therapy with Lithium or Valproate

The efficacy of RISPERDAL[®] with concomitant lithium or valproate in the treatment of acute manic or mixed episodes was established in one controlled trial in adult patients who met the DSM-IV criteria for Bipolar I Disorder. This trial included patients with or without psychotic features and with or without a rapid-cycling course.

- (1) In this 3-week placebo-controlled combination trial, 148 in- or outpatients on lithium or valproate therapy with inadequately controlled manic or mixed symptoms were randomized to receive RISPERDAL[®], placebo, or an active comparator, in combination with their original therapy. RISPERDAL[®], in a dose range of 1-6 mg/day, once daily, starting at 2 mg/day (mean modal dose of 3.8 mg/day), combined with lithium or valproate (in a therapeutic range of 0.6 mEq/L to 1.4 mEq/L or 50 mcg/mL to 120 mcg/mL, respectively) was superior to lithium or valproate alone in the reduction of YMRS total score.
- (2) In a second 3-week placebo-controlled combination trial, 142 in- or outpatients on lithium, valproate, or carbamazepine therapy with inadequately controlled manic or mixed symptoms were randomized to receive RISPERDAL[®] or placebo, in combination with their original therapy. RISPERDAL[®], in a dose range of 1-6 mg/day, once daily, starting at 2 mg/day (mean modal dose of 3.7 mg/day), combined with lithium, valproate, or carbamazepine (in therapeutic ranges of 0.6 mEq/L to 1.4 mEq/L for lithium, 50 mcg/mL to 125 mcg/mL for valproate, or 4-12 mcg/mL for carbamazepine, respectively) was not superior to lithium, valproate, or carbamazepine alone in the reduction of YMRS total score. A possible explanation for the failure of this trial was induction of risperidone and 9-hydroxyrisperidone clearance by carbamazepine, leading to subtherapeutic levels of risperidone and 9-hydroxyrisperidone.

14.4 Irritability Associated with Autistic Disorder

Short-Term Efficacy

The efficacy of RISPERDAL[®] in the treatment of irritability associated with autistic disorder was established in two 8-week, placebo-controlled trials in children and adolescents (aged 5 to 16 years) who met the DSM-IV criteria for autistic disorder. Over 90% of these subjects were under 12 years of age and most weighed over 20 kg (16-104.3 kg).

Efficacy was evaluated using two assessment scales: the Aberrant Behavior Checklist (ABC) and the Clinical Global Impression - Change (CGI-C) scale. The primary outcome measure in both trials was the change from baseline to endpoint in the Irritability subscale of the ABC (ABC-I). The ABC-I subscale measured the emotional and behavioral symptoms of autism, including aggression towards others, deliberate self-injuriousness, temper tantrums, and quickly changing moods. The CGI-C rating at endpoint was a co-primary outcome measure in one of the studies.

The results of these trials are as follows:

- (1) In one of the 8-week, placebo-controlled trials, children and adolescents with autistic disorder (n=101), aged 5 to 16 years, received twice daily doses of placebo or RISPERDAL[®] 0.5-3.5 mg/day on a weight-adjusted basis. RISPERDAL[®], starting at 0.25 mg/day or 0.5 mg/day depending on baseline weight (< 20 kg and ≥ 20 kg, respectively) and titrated to clinical response (mean modal dose of 1.9 mg/day, equivalent to 0.06 mg/kg/day), significantly improved scores on the ABC-I subscale and on the CGI-C scale compared with placebo.
- (2) In the other 8-week, placebo-controlled trial in children with autistic disorder (n=55), aged 5 to 12 years, RISPERDAL[®] 0.02 to 0.06 mg/kg/day given once or twice daily, starting at 0.01 mg/kg/day and titrated to clinical response (mean modal dose of 0.05 mg/kg/day, equivalent to 1.4 mg/day), significantly improved scores on the ABC-I subscale compared with placebo.

A third trial was a 6-week, multicenter, randomized, double-blind, placebo-controlled, fixed-dose study to evaluate the efficacy and safety of a lower than recommended dose of risperidone in subjects (N=96) 5 to 17 years of age with autistic disorder (defined by DSM-IV criteria) and associated irritability and related behavioral symptoms. Approximately 77% of patients were younger than 12 years of age (mean age = 9), and 88% were male. Most patients (73%) weighed less than 45 kg (mean weight = 40 kg). Approximately 90% of patients were antipsychotic-naïve before entering the study.

There were two weight-based, fixed doses of risperidone (high-dose and low-dose). The high dose was 1.25 mg per day for patients weighing 20 to < 45 kg, and it was 1.75 mg per day for patients weighing ≥ 45 kg. The low dose was 0.125 mg per day for patients weighing 20 to < 45 kg, and it was 0.175 mg per day for patients weighing ≥ 45 kg. The dose was administered once daily in the morning, or in the evening if sedation occurred.

The primary efficacy endpoint was the mean change in the Aberrant Behavior Checklist – Irritability subscale (ABC-I) score from baseline to the end of Week 6. The study demonstrated

the efficacy of high-dose risperidone, as measured by the mean change in ABC-I score. It did not demonstrate efficacy for low-dose risperidone. The mean baseline ABC-I scores were 29 in the placebo group (n = 35), 27 in the risperidone low-dose group (n = 30), and 28 in the risperidone high-dose group (n = 31). The mean changes in ABC-I scores were -3.5, -7.4, and -12.4 in the placebo, low-dose, and high-dose group respectively. The results in the high-dose group were statistically significant ($p < 0.001$) but not in the low-dose group ($p = 0.164$).

Long-Term Efficacy

Following completion of the first 8-week double-blind study, 63 patients entered an open-label study extension where they were treated with RISPERDAL[®] for 4 or 6 months (depending on whether they received RISPERDAL[®] or placebo in the double-blind study). During this open-label treatment period, patients were maintained on a mean modal dose of RISPERDAL[®] of 1.8-2.1 mg/day (equivalent to 0.05 - 0.07 mg/kg/day).

Patients who maintained their positive response to RISPERDAL[®] (response was defined as $\geq 25\%$ improvement on the ABC-I subscale and a CGI-C rating of ‘much improved’ or ‘very much improved’) during the 4-6 month open-label treatment phase for about 140 days, on average, were randomized to receive RISPERDAL[®] or placebo during an 8-week, double-blind withdrawal study (n=39 of the 63 patients). A pre-planned interim analysis of data from patients who completed the withdrawal study (n=32), undertaken by an independent Data Safety Monitoring Board, demonstrated a significantly lower relapse rate in the RISPERDAL[®] group compared with the placebo group. Based on the interim analysis results, the study was terminated due to demonstration of a statistically significant effect on relapse prevention. Relapse was defined as $\geq 25\%$ worsening on the most recent assessment of the ABC-I subscale (in relation to baseline of the randomized withdrawal phase).

16 HOW SUPPLIED/STORAGE AND HANDLING

16.1 How Supplied

RISPERDAL[®] (risperidone) Tablets

RISPERDAL[®] (risperidone) Tablets are imprinted "JANSSEN" on one side and either "Ris 0.25", "Ris 0.5", "R1", "R2", "R3", or "R4" according to their respective strengths.

0.25 mg dark yellow, capsule-shaped tablets: bottles of 60 NDC 50458-301-04, bottles of 500 NDC 50458-301-50, and hospital unit dose blister packs of 100 NDC 50458-301-01.

0.5 mg red-brown, capsule-shaped tablets: bottles of 60 NDC 50458-302-06, bottles of 500 NDC 50458-302-50, and hospital unit dose blister packs of 100 NDC 50458-302-01.

1 mg white, capsule-shaped tablets: bottles of 60 NDC 50458-300-06, bottles of 500 NDC 50458-300-50, and hospital unit dose blister packs of 100 NDC 50458-300-01.

2 mg orange, capsule-shaped tablets: bottles of 60 NDC 50458-320-06, bottles of 500 NDC 50458-320-50, and hospital unit dose blister packs of 100 NDC 50458-320-01.

3 mg yellow, capsule-shaped tablets: bottles of 60 NDC 50458-330-06, bottles of 500 NDC 50458-330-50, and hospital unit dose blister packs of 100 NDC 50458-330-01.

4 mg green, capsule-shaped tablets: bottles of 60 NDC 50458-350-06 and hospital unit dose blister packs of 100 NDC 50458-350-01.

RISPERDAL[®] (risperidone) Oral Solution

RISPERDAL[®] (risperidone) 1 mg/mL Oral Solution (NDC 50458-305-03) is supplied in 30 mL bottles with a calibrated (in milligrams and milliliters) pipette. The minimum calibrated volume is 0.25 mL, while the maximum calibrated volume is 3 mL.

RISPERDAL[®] M-TAB[®] (risperidone) Orally Disintegrating Tablets

RISPERDAL[®] M-TAB[®] (risperidone) Orally Disintegrating Tablets are etched on one side with “R0.5”, “R1”, “R2”, “R3”, or “R4” according to their respective strengths. RISPERDAL[®] M-TAB[®] Orally Disintegrating Tablets 0.5 mg, 1 mg, and 2 mg are packaged in blister packs of 4 (2 X 2) tablets. Orally Disintegrating Tablets 3 mg and 4 mg are packaged in a child-resistant pouch containing a blister with 1 tablet.

0.5 mg light coral, round, biconvex tablets: 7 blister packages (4 tablets each) per box, NDC 50458-395-28, and long-term care blister packaging of 30 tablets NDC 50458-395-30.

1 mg light coral, square, biconvex tablets: 7 blister packages (4 tablets each) per box, NDC 50458-315-28, and long-term care blister packaging of 30 tablets NDC 50458-315-30.

2 mg coral, square, biconvex tablets: 7 blister packages (4 tablets each) per box, NDC 50458-325-28.

3 mg coral, round, biconvex tablets: 28 blisters per box, NDC 50458-335-28.

4 mg coral, round, biconvex tablets: 28 blisters per box, NDC 50458-355-28.

16.2 Storage and Handling

RISPERDAL[®] Tablets should be stored at controlled room temperature 15°-25°C (59°-77°F). Protect from light and moisture.

RISPERDAL[®] 1 mg/mL Oral Solution should be stored at controlled room temperature 15°-25°C (59°-77°F). Protect from light and freezing.

RISPERDAL[®] M-TAB[®] Orally Disintegrating Tablets should be stored at controlled room temperature 15°-25°C (59°-77°F).

Keep out of reach of children.

17 PATIENT COUNSELING INFORMATION

Physicians are advised to discuss the following issues with patients for whom they prescribe RISPERDAL[®] and their caregivers:

17.1 Orthostatic Hypotension

Advise patients and caregivers about the risk of orthostatic hypotension, especially during the period of initial dose titration [*see Warnings and Precautions (5.7)*].

17.2 Interference with Cognitive and Motor Performance

Inform patients and caregivers that RISPERDAL[®] has the potential to impair judgment, thinking, or motor skills. Advise caution about operating hazardous machinery, including automobiles, until patients are reasonably certain that RISPERDAL[®] therapy does not affect them adversely [*see Warnings and Precautions (5.9)*].

17.3 Pregnancy

Advise patients and caregivers to notify their physician if the patient becomes pregnant or intends to become pregnant during therapy [*see Use in Specific Populations (8.1)*].

17.4 Nursing

Inform patients and caregivers that risperidone and its active metabolite are present in human breast milk; there is a potential for serious adverse reactions from RISPERDAL[®] in nursing infants. Advise patients that the decision whether to discontinue nursing or to discontinue the RISPERDAL[®] should take into account the importance of the drug to the patient [*see Use in Specific Populations (8.3)*].

17.5 Concomitant Medication

Advise patients and caregivers to inform their physicians if the patient is taking, or plans to take, any prescription or over-the-counter drugs, because there is a potential for interactions [*see Drug Interactions (7)*].

17.6 Alcohol

Advise patients to avoid alcohol while taking RISPERDAL[®] [*see Drug Interactions (7.2)*].

17.7 Phenylketonurics

Inform patients with Phenylketonuria and caregivers that RISPERDAL[®] M-TAB[®] Orally Disintegrating Tablets contain phenylalanine. Phenylalanine is a component of aspartame. Each 4 mg RISPERDAL[®] M-TAB[®] Orally Disintegrating Tablet contains 0.84 mg phenylalanine; each 3 mg RISPERDAL[®] M-TAB[®] Orally Disintegrating Tablet contains 0.63 mg phenylalanine; each 2 mg RISPERDAL[®] M-TAB[®] Orally Disintegrating Tablet contains 0.42 mg phenylalanine; each 1 mg RISPERDAL[®] M-TAB[®] Orally Disintegrating Tablet contains 0.28 mg phenylalanine; and each 0.5 mg RISPERDAL[®] M-TAB[®] Orally Disintegrating Tablet contains 0.14 mg phenylalanine [*see Warnings and Precautions (5.14)*].

17.8 Metabolic Changes

Inform patients and caregivers that treatment with RISPERDAL[®] can be associated with hyperglycemia and diabetes mellitus, dyslipidemia, and weight gain [*see Warnings and Precautions (5.5)*].

17.9 Tardive Dyskinesia

Inform patients and caregivers about the risk of tardive dyskinesia [*see Warnings and Precautions (5.4)*].

RISPERDAL[®] Tablets

Active ingredient is made in Ireland
Finished product is manufactured by:
Janssen Ortho, LLC
Gurabo, Puerto Rico 00778

RISPERDAL[®] Oral Solution

Finished product is manufactured by:
Janssen Pharmaceutica NV
Beerse, Belgium

RISPERDAL[®] M-TAB[®] Orally Disintegrating Tablets

Active ingredient is made in Ireland
Finished product is manufactured by:
Janssen Ortho, LLC
Gurabo, Puerto Rico 00778

RISPERDAL[®] Tablets, RISPERDAL[®] M-TAB[®] Orally Disintegrating Tablets, and
RISPERDAL[®] Oral Solution are manufactured for:

Janssen Pharmaceuticals, Inc.

Titusville, NJ 08560

Revised Month 2016

© Janssen Pharmaceuticals, Inc. 2007

HIGHLIGHTS OF PRESCRIBING INFORMATION

These highlights do not include all the information needed to use RISPERDAL CONSTA® safely and effectively. See full prescribing information for RISPERDAL CONSTA®.

RISPERDAL CONSTA® (risperidone) LONG-ACTING INJECTION

Initial U.S. Approval: 2003

WARNING: INCREASED MORTALITY IN ELDERLY PATIENTS WITH DEMENTIA-RELATED PSYCHOSIS

See full prescribing information for complete boxed warning. Elderly patients with dementia-related psychosis treated with antipsychotic drugs are at an increased risk of death. RISPERDAL CONSTA® is not approved for use in patients with dementia-related psychosis. (5.1)

INDICATIONS AND USAGE

RISPERDAL CONSTA® is an atypical antipsychotic indicated:

- for the treatment of schizophrenia. (1.1)
- as monotherapy or as adjunctive therapy to lithium or valproate for the maintenance treatment of Bipolar I Disorder. (1.2)

DOSAGE AND ADMINISTRATION

- For patients who have never taken oral RISPERDAL®, tolerability should be established with oral RISPERDAL® prior to initiating treatment with RISPERDAL CONSTA®. (2)
- Administer by deep intramuscular (IM) deltoid or gluteal injection. Each injection should be administered by a health care professional using the appropriate enclosed safety needle (1-inch for deltoid administration alternating injections between the two arms and 2-inch for gluteal administration alternating injections between the two buttocks). Do not administer intravenously. (2)
- 25 mg intramuscular (IM) every 2 weeks. Patients not responding to 25 mg may benefit from a higher dose of 37.5 mg or 50 mg. The maximum dose should not exceed 50 mg every 2 weeks. (2)
- Oral RISPERDAL® (or another antipsychotic medication) should be given with the first injection of RISPERDAL CONSTA®, and continued for 3 weeks (and then discontinued) to ensure adequate therapeutic plasma concentrations from RISPERDAL CONSTA®. (2)
- Upward dose adjustment of RISPERDAL CONSTA® should not be made more frequently than every 4 weeks. Clinical effects of each upward dose adjustment should not be anticipated earlier than 3 weeks after injection. (2)
- Avoid inadvertent administration into a blood vessel. (5.15)
- See Full Prescribing Information Section 2.8 for instructions for use.

DOSAGE FORMS AND STRENGTHS

Vial kits: 12.5 mg, 25 mg, 37.5 mg, and 50 mg (3)

CONTRAINDICATIONS

- Known hypersensitivity to risperidone, paliperidone, or to any excipients in RISPERDAL CONSTA®. (4)

WARNINGS AND PRECAUTIONS

- Cerebrovascular events, including stroke, in elderly patients with dementia-related psychosis. RISPERDAL CONSTA® is not approved for use in patients with dementia-related psychosis (5.2)
- Neuroleptic Malignant Syndrome: Manage with immediate discontinuation and close monitoring (5.3)
- Tardive Dyskinesia: Discontinue treatment if clinically appropriate (5.4)
- Metabolic Changes: Atypical antipsychotic drugs have been associated with metabolic changes that may increase cardiovascular/cerebrovascular risk. These metabolic changes include hyperglycemia, dyslipidemia, and weight gain. (5.5)
 - *Hyperglycemia and Diabetes Mellitus*: Monitor patients for symptoms of hyperglycemia including polydipsia, polyuria, polyphagia, and weakness. Monitor glucose regularly in patients with diabetes or at risk for diabetes. (5.5)
 - *Dyslipidemia*: Undesirable alterations have been observed in patients treated with atypical antipsychotics. (5.5)
 - *Weight Gain*: Significant weight gain has been reported. Monitor weight gain. (5.5)
- Hyperprolactinemia: Risperidone treatment may elevate prolactin levels. Long-standing hyperprolactinemia, when associated with hypogonadism, can lead to decreased bone density in men and women. (5.6)

- Orthostatic hypotension: associated with dizziness, tachycardia, bradycardia, and syncope can occur, especially during initial dose titration with oral risperidone. Use caution in patients with cardiovascular disease, cerebrovascular disease, and conditions that could affect hemodynamic responses. (5.7)
- Leukopenia, Neutropenia, and Agranulocytosis have been reported with antipsychotics, including RISPERDAL CONSTA®. Patients with history of a clinically significant low white blood cell count (WBC) or a drug-induced leukopenia/neutropenia should have their complete blood cell count (CBC) monitored frequently during the first few months of therapy and discontinuation of RISPERDAL CONSTA® should be considered at the first sign of a clinically significant decline in WBC in the absence of other causative factors. (5.8)
- Potential for cognitive and motor impairment: has potential to impair judgment, thinking, and motor skills. Use caution when operating machinery, including automobiles. (5.9)
- Seizures: Use cautiously in patients with a history of seizures or with conditions that potentially lower the seizure threshold. (5.10)
- Dysphagia: Esophageal dysmotility and aspiration can occur. Use cautiously in patients at risk for aspiration pneumonia. (5.11)
- Priapism: has been reported. Severe priapism may require surgical intervention. (5.12)
- Thrombotic Thrombocytopenic Purpura (TTP): has been reported. (5.13)
- Avoid inadvertent administration into a blood vessel. (5.15)
- Suicide: There is increased risk of suicide attempt in patients with schizophrenia or bipolar disorder, and close supervision of high-risk patients should accompany drug therapy. (5.17)
- Increased sensitivity in patients with Parkinson's disease or those with dementia with Lewy bodies: has been reported. Manifestations include mental status changes, motor impairment, extrapyramidal symptoms, and features consistent with Neuroleptic Malignant Syndrome. (5.18)
- Diseases or conditions that could affect metabolism or hemodynamic responses: Use with caution in patients with such medical conditions (e.g., recent myocardial infarction or unstable cardiac disease). (5.18)

ADVERSE REACTIONS

The most common adverse reactions in clinical trials in patients with schizophrenia ($\geq 5\%$) were headache, parkinsonism, dizziness, akathisia, fatigue, constipation, dyspepsia, sedation, weight increased, pain in extremity, and dry mouth. The most common adverse reactions in clinical trials in patients with bipolar disorder were weight increased (5% in monotherapy trial) and tremor and parkinsonism ($\geq 10\%$ in adjunctive therapy trial). (6)

The most common adverse reactions that were associated with discontinuation from clinical trials in patients with schizophrenia were agitation, depression, anxiety, and akathisia. Adverse reactions that were associated with discontinuation from bipolar disorder trials were hyperglycemia (one subject monotherapy trial) and hypokinesia and tardive dyskinesia (one subject each in adjunctive therapy trial). (6)

To report SUSPECTED ADVERSE REACTIONS, contact Janssen Pharmaceuticals, Inc. at 1-800-JANSSEN (1-800-526-7736) or FDA at 1-800-FDA-1088 or www.fda.gov/medwatch.

DRUG INTERACTIONS

- Due to CNS effects, use caution when administering with other centrally-acting drugs. Avoid alcohol. (7.1)
- Due to hypotensive effects, hypotensive effects of other drugs with this potential may be enhanced. (7.2)
- Effects of levodopa and dopamine agonists may be antagonized. (7.3)
- Cimetidine and ranitidine increase the bioavailability of risperidone. (7.5)
- Clozapine may decrease clearance of risperidone. (7.6)
- Fluoxetine and paroxetine increase plasma concentrations of risperidone. (7.11)
- Carbamazepine and other enzyme inducers decrease plasma concentrations of risperidone. (7.12)

USE IN SPECIFIC POPULATIONS

- Renal or Hepatic Impairment: dose appropriately with oral RISPERDAL® prior to initiating treatment with RISPERDAL CONSTA®. A lower starting dose of RISPERDAL CONSTA® of 12.5 mg may be appropriate in some patients. (2.4)

- Nursing Mothers: should not breast feed. (8.3)
 - Pediatric Use: safety and effectiveness not established in patients less than 18 years of age. (8.4)
 - Elderly: dosing for otherwise healthy elderly patients is the same as for healthy nonelderly. Elderly may be more predisposed to orthostatic effects than nonelderly. (8.5)
-

See 17 for PATIENT COUNSELING INFORMATION

Revised: MM/20YY

FULL PRESCRIBING INFORMATION: CONTENTS*

WARNING: INCREASED MORTALITY IN ELDERLY PATIENTS WITH DEMENTIA-RELATED PSYCHOSIS

1 INDICATIONS AND USAGE

- 1.1 Schizophrenia
- 1.2 Bipolar Disorder

2 DOSAGE AND ADMINISTRATION

- 2.1 Schizophrenia
- 2.2 Bipolar Disorder
- 2.3 General Dosing Information
- 2.4 Dosage in Special Populations
- 2.5 Reinitiation of Treatment in Patients Previously Discontinued
- 2.6 Switching from Other Antipsychotics
- 2.7 Co-Administration of RISPERDAL CONSTA® with Certain Other Medications
- 2.8 Instructions for Use

3 DOSAGE FORMS AND STRENGTHS

4 CONTRAINDICATIONS

5 WARNINGS AND PRECAUTIONS

- 5.1 Increased Mortality in Elderly Patients with Dementia-Related Psychosis
- 5.2 Cerebrovascular Adverse Events, Including Stroke, in Elderly Patients with Dementia-Related Psychosis
- 5.3 Neuroleptic Malignant Syndrome (NMS)
- 5.4 Tardive Dyskinesia
- 5.5 Metabolic Changes
- 5.6 Hyperprolactinemia
- 5.7 Orthostatic Hypotension
- 5.8 Leukopenia, Neutropenia, and Agranulocytosis
- 5.9 Potential for Cognitive and Motor Impairment
- 5.10 Seizures
- 5.11 Dysphagia
- 5.12 Priapism
- 5.13 Thrombotic Thrombocytopenic Purpura (TTP)
- 5.14 Body Temperature Regulation
- 5.15 Administration
- 5.16 Antiemetic Effect
- 5.17 Suicide
- 5.18 Use in Patients with Concomitant Illness
- 5.19 Osteodystrophy and Tumors in Animals
- 5.20 Monitoring: Laboratory Tests

6 ADVERSE REACTIONS

- 6.1 Commonly-Observed Adverse Reactions in Double-Blind, Placebo-Controlled Clinical Trials - Schizophrenia
- 6.2 Commonly-Observed Adverse Reactions in Double-Blind, Placebo-Controlled Clinical Trials - Bipolar Disorder
- 6.3 Other Adverse Reactions Observed During the Clinical Trial Evaluation of Risperidone
- 6.4 Discontinuations Due to Adverse Reactions
- 6.5 Dose Dependency of Adverse Reactions in Clinical Trials
- 6.6 Changes in ECG

- 6.7 Pain Assessment and Local Injection Site Reactions
- 6.8 Postmarketing Experience

7 DRUG INTERACTIONS

- 7.1 Centrally-Acting Drugs and Alcohol
- 7.2 Drugs with Hypotensive Effects
- 7.3 Levodopa and Dopamine Agonists
- 7.4 Amitriptyline
- 7.5 Cimetidine and Ranitidine
- 7.6 Clozapine
- 7.7 Lithium
- 7.8 Valproate
- 7.9 Digoxin
- 7.10 Topiramate
- 7.11 Drugs That Inhibit CYP 2D6 and Other CYP Isozymes
- 7.12 Carbamazepine and Other CYP 3A4 Enzyme Inducers
- 7.13 Drugs Metabolized by CYP 2D6

8 USE IN SPECIFIC POPULATIONS

- 8.1 Pregnancy
- 8.2 Labor and Delivery
- 8.3 Nursing Mothers
- 8.4 Pediatric Use
- 8.5 Geriatric Use

9 DRUG ABUSE AND DEPENDENCE

- 9.1 Controlled Substance
- 9.2 Abuse
- 9.3 Dependence

10 OVERDOSAGE

- 10.1 Human Experience
- 10.2 Management of Overdosage

11 DESCRIPTION

12 CLINICAL PHARMACOLOGY

- 12.1 Mechanism of Action
- 12.2 Pharmacodynamics
- 12.3 Pharmacokinetics

13 NONCLINICAL TOXICOLOGY

- 13.1 Carcinogenesis, Mutagenesis, Impairment of Fertility

14 CLINICAL STUDIES

- 14.1 Schizophrenia
- 14.2 Bipolar Disorder - Monotherapy
- 14.3 Bipolar Disorder - Adjunctive Therapy

16 HOW SUPPLIED/STORAGE AND HANDLING

17 PATIENT COUNSELING INFORMATION

- 17.1 Orthostatic Hypotension
- 17.2 Interference with Cognitive and Motor Performance
- 17.3 Pregnancy
- 17.4 Nursing
- 17.5 Concomitant Medication
- 17.6 Alcohol

*Sections or subsections omitted from the full prescribing information are not listed

FULL PRESCRIBING INFORMATION

WARNING: INCREASED MORTALITY IN ELDERLY PATIENTS WITH DEMENTIA-RELATED PSYCHOSIS

Elderly patients with dementia-related psychosis treated with antipsychotic drugs are at an increased risk of death. Analyses of 17 placebo-controlled trials (modal duration of 10 weeks), largely in patients taking atypical antipsychotic drugs, revealed a risk of death in drug-treated patients of between 1.6 to 1.7 times the risk of death in placebo-treated patients. Over the course of a typical 10-week controlled trial, the rate of death in drug-treated patients was about 4.5%, compared to a rate of about 2.6% in the placebo group. Although the causes of death were varied, most of the deaths appeared to be either cardiovascular (e.g., heart failure, sudden death) or infectious (e.g., pneumonia) in nature. Observational studies suggest that, similar to atypical antipsychotic drugs, treatment with conventional antipsychotic drugs may increase mortality. The extent to which the findings of increased mortality in observational studies may be attributed to the antipsychotic drug as opposed to some characteristic(s) of the patients is not clear. RISPERDAL CONSTA[®] (risperidone) is not approved for the treatment of patients with dementia-related psychosis. [see *Warnings and Precautions (5.1)*]

1 INDICATIONS AND USAGE

1.1 Schizophrenia

RISPERDAL CONSTA[®] (risperidone) is indicated for the treatment of schizophrenia [see *Clinical Studies (14.1)*].

1.2 Bipolar Disorder

RISPERDAL CONSTA[®] is indicated as monotherapy or as adjunctive therapy to lithium or valproate for the maintenance treatment of Bipolar I Disorder [see *Clinical Studies (14.2, 14.3)*].

2 DOSAGE AND ADMINISTRATION

For patients who have never taken oral RISPERDAL[®], it is recommended to establish tolerability with oral RISPERDAL[®] prior to initiating treatment with RISPERDAL CONSTA[®].

RISPERDAL CONSTA[®] should be administered every 2 weeks by deep intramuscular (IM) deltoid or gluteal injection. Each injection should be administered by a health care professional using the appropriate enclosed safety needle [see *Dosage and Administration (2.8)*]. For deltoid administration, use the 1-inch needle alternating injections between the two arms. For gluteal administration, use the 2-inch needle alternating injections between the two buttocks. Do not administer intravenously.

2.1 Schizophrenia

The recommended dose for the treatment of schizophrenia is 25 mg IM every 2 weeks. Although dose response for effectiveness has not been established for RISPERDAL CONSTA[®], some patients not responding to 25 mg may benefit from a higher dose of 37.5 mg or 50 mg. The

maximum dose should not exceed 50 mg RISPERDAL CONSTA[®] every 2 weeks. No additional benefit was observed with dosages greater than 50 mg RISPERDAL CONSTA[®]; however, a higher incidence of adverse effects was observed.

The efficacy of RISPERDAL CONSTA[®] in the treatment of schizophrenia has not been evaluated in controlled clinical trials for longer than 12 weeks. Although controlled studies have not been conducted to answer the question of how long patients with schizophrenia should be treated with RISPERDAL CONSTA[®], oral risperidone has been shown to be effective in delaying time to relapse in longer-term use. It is recommended that responding patients be continued on treatment with RISPERDAL CONSTA[®] at the lowest dose needed. The physician who elects to use RISPERDAL CONSTA[®] for extended periods should periodically re-evaluate the long-term risks and benefits of the drug for the individual patient.

2.2 Bipolar Disorder

The recommended dose for monotherapy or adjunctive therapy to lithium or valproate for the maintenance treatment of Bipolar I Disorder is 25 mg IM every 2 weeks. Some patients may benefit from a higher dose of 37.5 mg or 50 mg. Dosages above 50 mg have not been studied in this population. The physician who elects to use RISPERDAL CONSTA[®] for extended periods should periodically re-evaluate the long-term risks and benefits of the drug for the individual patient.

2.3 General Dosing Information

A lower initial dose of 12.5 mg may be appropriate when clinical factors warrant dose adjustment, such as in patients with hepatic or renal impairment, for certain drug interactions that increase risperidone plasma concentrations [*see Drug Interactions (7.11)*] or in patients who have a history of poor tolerability to psychotropic medications. The efficacy of the 12.5 mg dose has not been investigated in clinical trials.

Oral RISPERDAL[®] (or another antipsychotic medication) should be given with the first injection of RISPERDAL CONSTA[®] and continued for 3 weeks (and then discontinued) to ensure that adequate therapeutic plasma concentrations are maintained prior to the main release phase of risperidone from the injection site [*see Clinical Pharmacology (12.3)*].

Upward dose adjustment should not be made more frequently than every 4 weeks. The clinical effects of this dose adjustment should not be anticipated earlier than 3 weeks after the first injection with the higher dose.

In patients with clinical factors such as hepatic or renal impairment or certain drug interactions that increase risperidone plasma concentrations [*see Drug Interactions (7.11)*], dose reduction as

low as 12.5 mg may be appropriate. The efficacy of the 12.5 mg dose has not been investigated in clinical trials.

Do not combine two different dose strengths of RISPERDAL CONSTA[®] in a single administration.

2.4 Dosage in Special Populations

Elderly

For elderly patients treated with RISPERDAL CONSTA[®], the recommended dosage is 25 mg IM every 2 weeks. Oral RISPERDAL[®] (or another antipsychotic medication) should be given with the first injection of RISPERDAL CONSTA[®] and should be continued for 3 weeks to ensure that adequate therapeutic plasma concentrations are maintained prior to the main release phase of risperidone from the injection site [*see Clinical Pharmacology (12.3)*].

Renal or Hepatic Impairment

Patients with renal or hepatic impairment should be treated with titrated doses of oral RISPERDAL[®] prior to initiating treatment with RISPERDAL CONSTA[®]. The recommended starting dose is 0.5 mg oral RISPERDAL[®] twice daily during the first week, which can be increased to 1 mg twice daily or 2 mg once daily during the second week. If a total daily dose of at least 2 mg oral RISPERDAL[®] is well tolerated, an injection of 25 mg RISPERDAL CONSTA[®] can be administered every 2 weeks. Oral supplementation should be continued for 3 weeks after the first injection until the main release of risperidone from the injection site has begun. In some patients, slower titration may be medically appropriate. Alternatively, a starting dose of RISPERDAL CONSTA[®] of 12.5 mg may be appropriate. The efficacy of the 12.5 mg dose has not been investigated in clinical trials.

Patients with renal impairment may have less ability to eliminate risperidone than normal adults. Patients with impaired hepatic function may have an increase in the free fraction of the risperidone, possibly resulting in an enhanced effect [*see Clinical Pharmacology (12.3)*]. Elderly patients and patients with a predisposition to hypotensive reactions or for whom such reactions would pose a particular risk should be instructed in nonpharmacologic interventions that help to reduce the occurrence of orthostatic hypotension (e.g., sitting on the edge of the bed for several minutes before attempting to stand in the morning and slowly rising from a seated position). These patients should avoid sodium depletion or dehydration, and circumstances that accentuate hypotension (alcohol intake, high ambient temperature, etc.). Monitoring of orthostatic vital signs should be considered [*see Warnings and Precautions (5.7)*].

2.5 Reinitiation of Treatment in Patients Previously Discontinued

There are no data to specifically address reinitiation of treatment. When restarting patients who have had an interval off treatment with RISPERDAL CONSTA[®], supplementation with oral RISPERDAL[®] (or another antipsychotic medication) should be administered.

2.6 Switching from Other Antipsychotics

There are no systematically collected data to specifically address switching patients from other antipsychotics to RISPERDAL CONSTA[®], or concerning concomitant administration with other antipsychotics. Previous antipsychotics should be continued for 3 weeks after the first injection of RISPERDAL CONSTA[®] to ensure that therapeutic concentrations are maintained until the main release phase of risperidone from the injection site has begun [*see Clinical Pharmacology (12.3)*]. For patients who have never taken oral RISPERDAL[®], it is recommended to establish tolerability with oral RISPERDAL[®] prior to initiating treatment with RISPERDAL CONSTA[®]. As recommended with other antipsychotic medications, the need for continuing existing EPS medication should be re-evaluated periodically.

2.7 Co-Administration of RISPERDAL CONSTA[®] with Certain Other Medications

Co-administration of carbamazepine and other CYP 3A4 enzyme inducers (e.g., phenytoin, rifampin, phenobarbital) with risperidone would be expected to cause decreases in the plasma concentrations of the sum of risperidone and 9-hydroxyrisperidone combined, which could lead to decreased efficacy of RISPERDAL CONSTA[®] treatment. The dose of risperidone needs to be titrated accordingly for patients receiving these enzyme inducers, especially during initiation or discontinuation of therapy with these inducers [*see Drug Interactions (7.11)*]. At the initiation of therapy with carbamazepine or other known CYP 3A4 hepatic enzyme inducers, patients should be closely monitored during the first 4-8 weeks, since the dose of RISPERDAL CONSTA[®] may need to be adjusted. A dose increase, or additional oral RISPERDAL[®], may need to be considered. On discontinuation of carbamazepine or other CYP 3A4 hepatic enzyme inducers, the dosage of RISPERDAL CONSTA[®] should be re-evaluated and, if necessary, decreased. Patients may be placed on a lower dose of RISPERDAL CONSTA[®] between 2 to 4 weeks before the planned discontinuation of carbamazepine or other CYP 3A4 inducers to adjust for the expected increase in plasma concentrations of risperidone plus 9-hydroxyrisperidone. For patients treated with the recommended dose of 25 mg RISPERDAL CONSTA[®] and discontinuing from carbamazepine or other CYP3A4 enzyme inducers, it is recommended to continue treatment with the 25-mg dose unless clinical judgment necessitates lowering the RISPERDAL CONSTA[®] dose to 12.5 mg or necessitates interruption of RISPERDAL CONSTA[®] treatment. The efficacy of the 12.5 mg dose has not been investigated in clinical trials.

Fluoxetine and paroxetine, CYP 2D6 inhibitors, have been shown to increase the plasma concentration of risperidone 2.5-2.8 fold and 3-9 fold respectively. Fluoxetine did not affect the plasma concentration of 9-hydroxyrisperidone. Paroxetine lowered the concentration of 9-hydroxyrisperidone by about 10%. The dose of risperidone needs to be titrated accordingly when fluoxetine or paroxetine is co-administered. When either concomitant fluoxetine or paroxetine is initiated or discontinued, the physician should re-evaluate the dose of RISPERDAL CONSTA[®]. When initiation of fluoxetine or paroxetine is considered, patients may be placed on a lower dose of RISPERDAL CONSTA[®] between 2 to 4 weeks before the planned start of fluoxetine or paroxetine therapy to adjust for the expected increase in plasma concentrations of risperidone. When fluoxetine or paroxetine is initiated in patients receiving the recommended dose of 25 mg RISPERDAL CONSTA[®], it is recommended to continue treatment with the 25 mg dose unless clinical judgment necessitates lowering the RISPERDAL CONSTA[®] dose to 12.5 mg or necessitates interruption of RISPERDAL CONSTA[®] treatment. When RISPERDAL CONSTA[®] is initiated in patients already receiving fluoxetine or paroxetine, a starting dose of 12.5 mg can be considered. The efficacy of the 12.5 mg dose has not been investigated in clinical trials. The effects of discontinuation of concomitant fluoxetine or paroxetine therapy on the pharmacokinetics of risperidone and 9-hydroxyrisperidone have not been studied. [see *Drug Interactions (7.11)*]

2.8 Instructions for Use

For deltoid or gluteal intramuscular injection only

IMPORTANT RESOURCES

For additional information, visit www.risperdalconsta.com or call Janssen Pharmaceuticals, Inc. at 1-800-JANSSEN (1-800-526-7736).

Important Information

RISPERDAL CONSTA[®] requires close attention to these step-by-step Instructions for Use to help ensure successful administration.

Use components provided

The components in this dose pack are specifically designed for use with RISPERDAL CONSTA[®]. RISPERDAL CONSTA[®] must be reconstituted only in the diluent supplied in the dose pack.

Do not substitute ANY components of the dose pack.

Do not store suspension after reconstitution

Administer dose as soon as possible after reconstitution to avoid settling.

Proper dosing

The entire contents of the vial must be administered to ensure intended dose of RISPERDAL CONSTA[®] is delivered.

SINGLE-USE DEVICE

Do not reuse. Medical devices require specific material characteristics to perform as intended. These characteristics have been verified for single use only. Any attempt to re-process the device for subsequent re-use may adversely affect the integrity of the device or lead to deterioration in performance.

Dose pack contents

West-Medimop Vial Adapter[®]

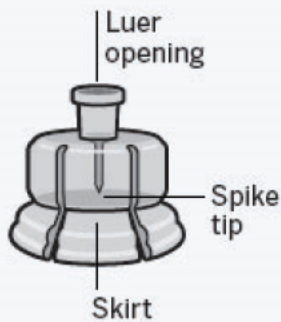

Prefilled Syringe

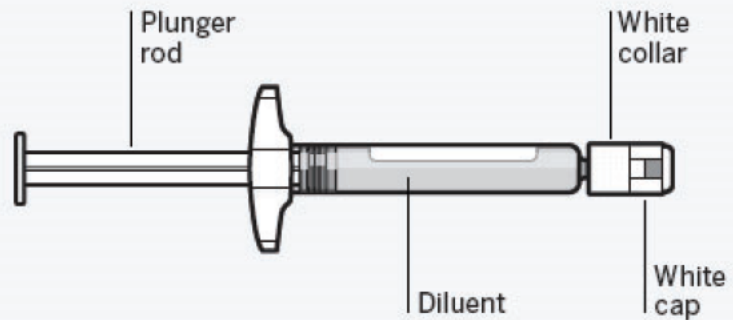

Vial



Terumo SurGuard[®] 3 Injection Needles

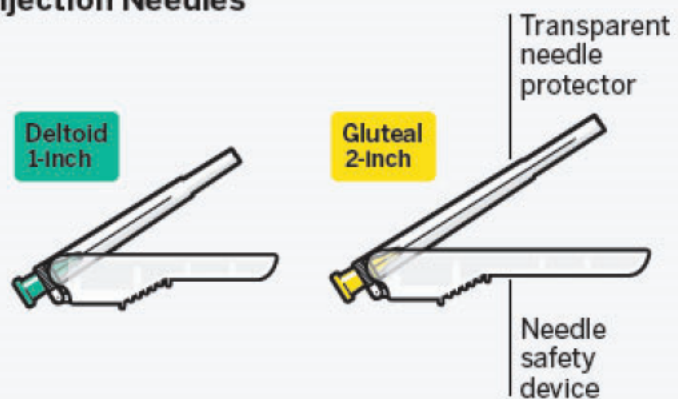

Step 1

Assemble components

Take out dose pack Connect vial adapter to vial



Wait 30 minutes
Remove dose pack from the refrigerator and allow to sit at room temperature for at least **30 minutes** before reconstituting.

Do not warm any other way.



Remove cap from vial
Flip off colored cap from vial.

Wipe top of the grey stopper with an alcohol swab. Allow to air dry.

Do not remove grey rubber stopper.

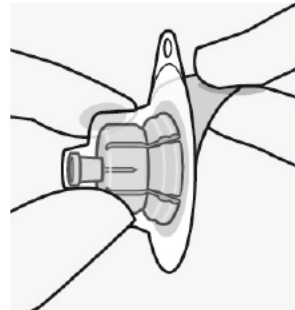

Prepare vial adapter
Hold sterile blister as shown. Peel back and remove paper backing.

Do not remove vial adapter from blister.

Do not touch spike tip at any time. This will result in contamination.



Connect vial adapter to vial
Place vial on a hard surface and hold by the base. Center vial adapter over the grey rubber stopper. Push vial adapter straight down onto vial top until it snaps securely into place.

Do not place vial adapter on at an angle or diluent may leak upon transfer to the vial.



Connect prefilled syringe to vial adapter

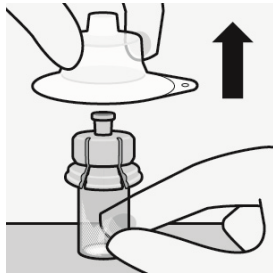

Remove sterile blister

Remove vial adapter from sterile blister only when you are ready to remove the white cap from the prefilled syringe.

Keep vial vertical to prevent leakage. Hold base of vial and pull up on the sterile blister to remove.

Do not shake.

Do not touch exposed luer opening on vial adapter. This will result in contamination.

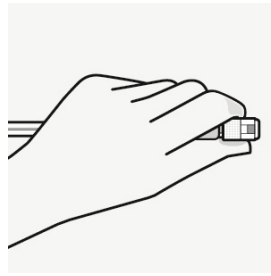

Use proper grip

Hold by white collar at the tip of the syringe.

Do not hold syringe by the glass barrel during assembly.

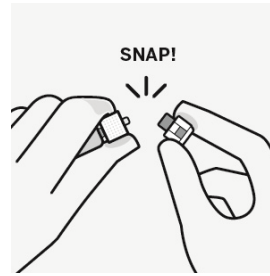
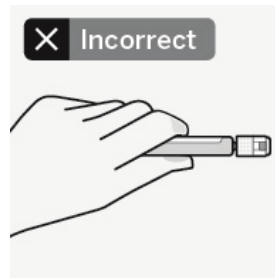

Remove cap

Holding the white collar, snap off the white cap.

Do not twist or cut off the white cap.

Do not touch syringe tip. This will result in contamination.

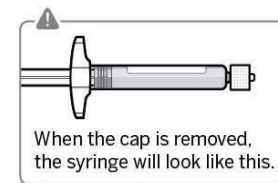

The broken-off cap can be discarded.

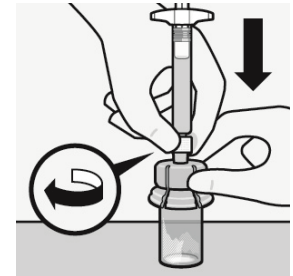

Connect syringe to vial adapter

Hold vial adapter by skirt to keep stationary.

Hold syringe by white collar then insert tip into the luer opening of the vial adapter.

Do not hold the glass syringe barrel. This may cause the white collar to loosen or detach.

Attach the syringe to the vial adapter with a firm **clockwise twisting motion** until it feels snug.

Do not over-tighten. Over-tightening may cause the syringe tip to break.

Step 2

Reconstitute microspheres

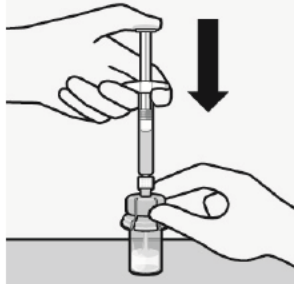

Inject diluent

Inject entire amount of diluent from syringe into the vial.



Vial contents will now be under pressure. **Keep holding the plunger rod down with thumb.**



Suspend microspheres in diluent

Continuing to hold down the plunger rod, **shake vigorously for at least 10 seconds**, as shown.

Check the suspension.

When properly mixed, the suspension appears uniform, thick and milky in color. Microspheres will be visible in the liquid.

Immediately proceed to the next step so suspension does not settle.

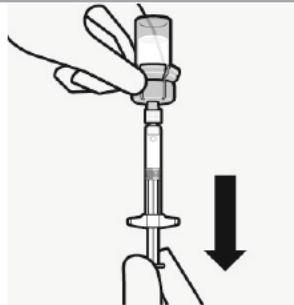

Transfer suspension to syringe

Invert vial completely. Slowly pull plunger rod down to withdraw entire contents from the vial into the syringe.

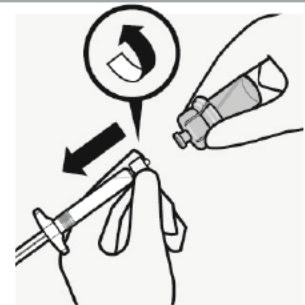

Remove vial adapter

Hold white collar on the syringe and unscrew from vial adapter.

Tear section of the vial label at the perforation. Apply detached label to the syringe for identification purposes.

Discard both vial and vial adapter appropriately.

Step 3

Attach needle

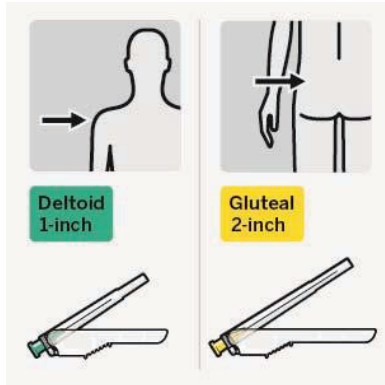

Select appropriate needle
Choose needle based on injection location (gluteal or deltoid).

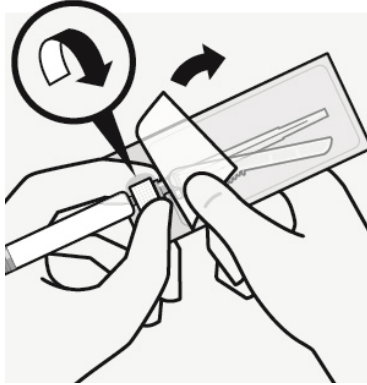

Attach needle
Peel blister pouch open part way and use to grasp the base of the needle, as shown.

Holding the white collar on the syringe, attach syringe to needle luer connection with a firm **clockwise twisting motion** until snug.

Do not touch needle luer opening. This will result in contamination.

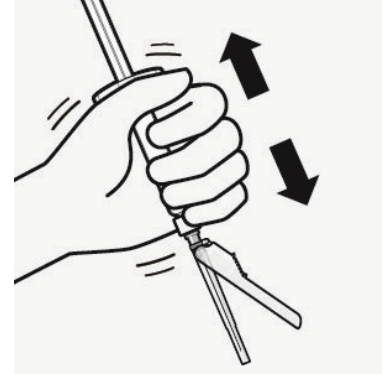

Resuspend microspheres
Fully remove the blister pouch.

Just before injection, shake syringe vigorously again, as some settling will have occurred.

Step 4

Inject dose

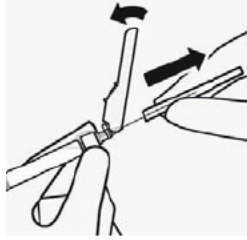

Remove transparent needle protector

Move the needle safety device back towards the syringe, as shown. Then hold white collar on syringe and carefully pull the transparent needle protector straight off.

Do not twist transparent needle protector, as the luer connection may loosen.

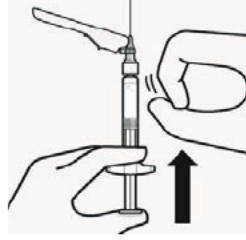

Remove air bubbles

Hold needle upright and tap gently to make any air bubbles rise to the top. Slowly and carefully press plunger rod upward to remove air.

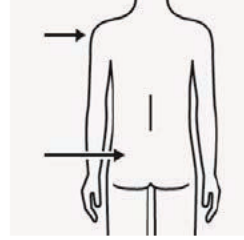

Inject

Immediately inject entire contents of syringe intramuscularly (IM) into the gluteal or deltoid muscle of the patient.

Gluteal injection should be made into the upper-outer quadrant of the gluteal area.

Do not administer intravenously.

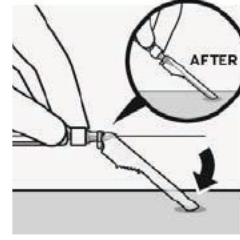

Secure needle in safety device

Using one hand, place needle safety device at a 45-degree angle on a hard, flat surface. Press down with a firm, quick motion until needle is fully engaged in safety device.

Avoid needle stick injury:

Do not use two hands.

Do not intentionally disengage or mishandle the needle safety device.

Do not attempt to straighten the needle or engage the safety device if the needle is bent or damaged.



Properly dispose of needles

Check to confirm needle safety device is fully engaged. Discard in an approved sharps container.

Also discard the unused needle provided in the dose pack.

3 DOSAGE FORMS AND STRENGTHS

RISPERDAL CONSTA[®] is available in dosage strengths of 12.5 mg, 25 mg, 37.5 mg, and 50 mg risperidone. It is provided as a dose pack, consisting of a vial containing the risperidone microspheres, a pre-filled syringe containing 2 mL of diluent for RISPERDAL CONSTA[®], a West-Medimop Vial Adapter[®], and two Terumo SurGuard[®] 3 Needles for intramuscular injection (a 21 G UTW 1-inch needle with needle protection device for deltoid administration and a 20 G TW 2-inch needle with needle protection device for gluteal administration).

4 CONTRAINDICATIONS

RISPERDAL CONSTA[®] is contraindicated in patients with a known hypersensitivity to either risperidone or paliperidone, or to any of the excipients in the RISPERDAL CONSTA[®] formulation. Hypersensitivity reactions, including anaphylactic reactions and angioedema, have been reported in patients treated with risperidone and in patients treated with paliperidone. Paliperidone is a metabolite of risperidone.

5 WARNINGS AND PRECAUTIONS

5.1 Increased Mortality in Elderly Patients with Dementia-Related Psychosis

Elderly patients with dementia-related psychosis treated with antipsychotic drugs are at an increased risk of death. RISPERDAL CONSTA[®] (risperidone) is not approved for the treatment of dementia-related psychosis (*see Boxed Warning*).

5.2 Cerebrovascular Adverse Events, Including Stroke, in Elderly Patients with Dementia-Related Psychosis

Cerebrovascular adverse events (e.g., stroke, transient ischemic attack), including fatalities, were reported in patients (mean age 85 years; range 73-97) in trials of oral risperidone in elderly patients with dementia-related psychosis. In placebo-controlled trials, there was a significantly higher incidence of cerebrovascular adverse events in patients treated with oral risperidone compared to patients treated with placebo. RISPERDAL CONSTA[®] is not approved for the treatment of patients with dementia-related psychosis. [*see also Boxed Warning and Warnings and Precautions (5.1)*]

5.3 Neuroleptic Malignant Syndrome (NMS)

A potentially fatal symptom complex sometimes referred to as Neuroleptic Malignant Syndrome (NMS) has been reported in association with antipsychotic drugs. Clinical manifestations of NMS are hyperpyrexia, muscle rigidity, altered mental status, and evidence of autonomic instability (irregular pulse or blood pressure, tachycardia, diaphoresis, and cardiac dysrhythmia). Additional signs may include elevated creatine phosphokinase, myoglobinuria (rhabdomyolysis), and acute renal failure.

The diagnostic evaluation of patients with this syndrome is complicated. In arriving at a diagnosis, it is important to identify cases in which the clinical presentation includes both serious medical illness (e.g., pneumonia, systemic infection, etc.) and untreated or inadequately treated extrapyramidal signs and symptoms (EPS). Other important considerations in the differential diagnosis include central anticholinergic toxicity, heat stroke, drug fever, and primary central nervous system pathology.

The management of NMS should include: (1) immediate discontinuation of antipsychotic drugs and other drugs not essential to concurrent therapy; (2) intensive symptomatic treatment and medical monitoring; and (3) treatment of any concomitant serious medical problems for which specific treatments are available. There is no general agreement about specific pharmacological treatment regimens for uncomplicated NMS.

If a patient requires antipsychotic drug treatment after recovery from NMS, the potential reintroduction of drug therapy should be carefully considered. The patient should be carefully monitored, since recurrences of NMS have been reported.

5.4 Tardive Dyskinesia

A syndrome of potentially irreversible, involuntary, dyskinetic movements may develop in patients treated with antipsychotic drugs. Although the prevalence of the syndrome appears to be highest among the elderly, especially elderly women, it is impossible to rely upon prevalence estimates to predict, at the inception of antipsychotic treatment, which patients are likely to develop the syndrome. Whether antipsychotic drug products differ in their potential to cause tardive dyskinesia is unknown.

The risk of developing tardive dyskinesia and the likelihood that it will become irreversible are believed to increase as the duration of treatment and the total cumulative dose of antipsychotic drugs administered to the patient increase. However, the syndrome can develop, although much less commonly, after relatively brief treatment periods at low doses.

There is no known treatment for established cases of tardive dyskinesia, although the syndrome may remit, partially or completely, if antipsychotic treatment is withdrawn. Antipsychotic treatment, itself, however, may suppress (or partially suppress) the signs and symptoms of the syndrome and thereby may possibly mask the underlying process. The effect that symptomatic suppression has upon the long-term course of the syndrome is unknown.

Given these considerations, RISPERDAL CONSTA[®] should be prescribed in a manner that is most likely to minimize the occurrence of tardive dyskinesia. Chronic antipsychotic treatment should generally be reserved for patients who suffer from a chronic illness that: (1) is known to respond to antipsychotic drugs, and (2) for whom alternative, equally effective, but potentially

less harmful treatments are not available or appropriate. In patients who do require chronic treatment, the smallest dose and the shortest duration of treatment producing a satisfactory clinical response should be sought. The need for continued treatment should be reassessed periodically.

If signs and symptoms of tardive dyskinesia appear in a patient treated with RISPERDAL CONSTA[®], drug discontinuation should be considered. However, some patients may require treatment with RISPERDAL CONSTA[®] despite the presence of the syndrome.

5.5 Metabolic Changes

Atypical antipsychotic drugs have been associated with metabolic changes that may increase cardiovascular/cerebrovascular risk. These metabolic changes include hyperglycemia, dyslipidemia, and body weight gain. While all of the drugs in the class have been shown to produce some metabolic changes, each drug has its own specific risk profile.

Hyperglycemia and Diabetes Mellitus

Hyperglycemia and diabetes mellitus, in some cases extreme and associated with ketoacidosis or hyperosmolar coma or death, have been reported in patients treated with atypical antipsychotics including RISPERDAL[®]. Assessment of the relationship between atypical antipsychotic use and glucose abnormalities is complicated by the possibility of an increased background risk of diabetes mellitus in patients with schizophrenia and the increasing incidence of diabetes mellitus in the general population. Given these confounders, the relationship between atypical antipsychotic use and hyperglycemia-related adverse events is not completely understood. However, epidemiological studies suggest an increased risk of treatment-emergent hyperglycemia-related adverse events in patients treated with the atypical antipsychotics. Precise risk estimates for hyperglycemia-related adverse events in patients treated with atypical antipsychotics are not available.

Patients with an established diagnosis of diabetes mellitus who are started on atypical antipsychotics, including RISPERDAL[®], should be monitored regularly for worsening of glucose control. Patients with risk factors for diabetes mellitus (e.g., obesity, family history of diabetes) who are starting treatment with atypical antipsychotics, including RISPERDAL[®], should undergo fasting blood glucose testing at the beginning of treatment and periodically during treatment. Any patient treated with atypical antipsychotics, including RISPERDAL[®], should be monitored for symptoms of hyperglycemia including polydipsia, polyuria, polyphagia, and weakness. Patients who develop symptoms of hyperglycemia during treatment with atypical antipsychotics, including RISPERDAL[®], should undergo fasting blood glucose testing. In some cases, hyperglycemia has resolved when the atypical antipsychotic, including RISPERDAL[®],

was discontinued; however, some patients required continuation of anti-diabetic treatment despite discontinuation of RISPERDAL[®].

Pooled data from 3 double-blind, placebo-controlled studies in subjects with schizophrenia and 4 double-blind, placebo-controlled monotherapy studies in subjects with bipolar mania with oral risperidone are presented in Table 1.

Table 1. Change in Random Glucose From Seven Placebo-Controlled, 3- to 8-Week, Fixed- or Flexible-Dose Studies in Adult Subjects With Schizophrenia or Bipolar Mania With Oral Risperidone

	Placebo	RISPERDAL [®]	
		1-8 mg/day	>8-16 mg/day
		Mean change from baseline (mg/dL)	
	N=555	N=748	N=164
Serum Glucose	-1.4	0.8	0.6
		Proportion of patients with shifts	
Serum Glucose (<140 mg/dL to ≥200 mg/dL)	0.6% (3/525)	0.4% (3/702)	0% (0/158)

In longer-term, controlled and uncontrolled studies in adult subjects, RISPERDAL[®] was associated with a mean change in glucose of +2.8 mg/dL at Week 24 (N=151) and +4.1 mg/dL at Week 48 (N=50).

Dyslipidemia

Undesirable alterations in lipids have been observed in patients treated with atypical antipsychotics.

Pooled data from 7 placebo-controlled, 3- to 8- week, fixed- or flexible-dose studies in adult subjects with schizophrenia or bipolar mania are presented in Table 2.

Table 2. Change in Random Lipids From Seven Placebo-Controlled, 3- to 8-Week, Fixed- or Flexible-Dose Studies in Adult Subjects With Schizophrenia or Bipolar Mania With Oral Risperidone

	Placebo	RISPERDAL [®]	
		1-8 mg/day	>8-16 mg/day
		Mean change from baseline (mg/dL)	
Cholesterol	N=559	N=742	N=156
Change from baseline	0.6	6.9	1.8
Triglycerides	N=183	N=307	N=123
Change from baseline	-17.4	-4.9	-8.3
		Proportion of patients With Shifts	
Cholesterol (<200 mg/dL to ≥240 mg/dL)	2.7% (10/368)	4.3% (22/516)	6.3% (6/96)
Triglycerides (<500 mg/dL to ≥500 mg/dL)	1.1% (2/180)	2.7% (8/301)	2.5% (3/121)

In longer-term, controlled and uncontrolled studies, RISPERDAL[®] was associated with a mean change in (a) non-fasting cholesterol of +4.4 mg/dL at Week 24 (N=231) and +5.5 mg/dL at Week 48 (N=86); and (b) non-fasting triglycerides of +19.9 mg/dL at Week 24 (N=52).

Weight Gain

Weight gain has been observed with atypical antipsychotic use. Clinical monitoring of weight is recommended.

Data from a placebo-controlled, 12-week, fixed-dose study in adult subjects with schizophrenia are presented in Table 3.

Table 3. Mean Change in Body Weight (kg) and the Proportion of Subjects With $\geq 7\%$ Gain in Body Weight From a Placebo-Controlled, 12-Week, Fixed-Dose Study in Adult Subjects With Schizophrenia

	Placebo (N=83)	RISPERDAL CONSTA [®]	
		25 mg (N=90)	50 mg (N=87)
Weight (kg)			
Change from baseline	-1.4	0.5	1.2
Weight Gain			
$\geq 7\%$ increase from baseline	6%	10%	8%

In an uncontrolled, longer-term, open-label study, RISPERDAL CONSTA[®] was associated with a mean change in weight of +2.1 kg at Week 24 (N=268) and +2.8 kg at Week 50 (N=199).

5.6 Hyperprolactinemia

As with other drugs that antagonize dopamine D₂ receptors, risperidone elevates prolactin levels and the elevation persists during chronic administration. Risperidone is associated with higher levels of prolactin elevation than other antipsychotic agents.

Hyperprolactinemia may suppress hypothalamic GnRH, resulting in reduced pituitary gonadotropin secretion. This, in turn, may inhibit reproductive function by impairing gonadal steroidogenesis in both female and male patients. Galactorrhea, amenorrhea, gynecomastia, and impotence have been reported in patients receiving prolactin-elevating compounds. Long-standing hyperprolactinemia when associated with hypogonadism may lead to decreased bone density in both female and male subjects.

Tissue culture experiments indicate that approximately one-third of human breast cancers are prolactin dependent *in vitro*, a factor of potential importance if the prescription of these drugs is contemplated in a patient with previously detected breast cancer. An increase in pituitary gland, mammary gland, and pancreatic islet cell neoplasia (mammary adenocarcinomas, pituitary and pancreatic adenomas) was observed in the risperidone carcinogenicity studies conducted in mice and rats [see *Nonclinical Toxicology (13.1)*]. Neither clinical studies nor epidemiologic studies

conducted to date have shown an association between chronic administration of this class of drugs and tumorigenesis in humans; the available evidence is considered too limited to be conclusive at this time.

5.7 Orthostatic Hypotension

RISPERDAL CONSTA[®] may induce orthostatic hypotension associated with dizziness, tachycardia, and in some patients, syncope, especially during the initial dose-titration period with oral risperidone, probably reflecting its alpha-adrenergic antagonistic properties. Syncope was reported in 0.8% (12/1499 patients) of patients treated with RISPERDAL CONSTA[®] in multiple-dose studies. Patients should be instructed in nonpharmacologic interventions that help to reduce the occurrence of orthostatic hypotension (e.g., sitting on the edge of the bed for several minutes before attempting to stand in the morning and slowly rising from a seated position).

RISPERDAL CONSTA[®] should be used with particular caution in (1) patients with known cardiovascular disease (history of myocardial infarction or ischemia, heart failure, or conduction abnormalities), cerebrovascular disease, and conditions which would predispose patients to hypotension, e.g., dehydration and hypovolemia, and (2) in the elderly and patients with renal or hepatic impairment. Monitoring of orthostatic vital signs should be considered in all such patients, and a dose reduction should be considered if hypotension occurs. Clinically significant hypotension has been observed with concomitant use of oral RISPERDAL[®] and antihypertensive medication.

5.8 Leukopenia, Neutropenia, and Agranulocytosis

Class Effect: In clinical trial and/or postmarketing experience, events of leukopenia/neutropenia have been reported temporally related to antipsychotic agents, including RISPERDAL CONSTA[®]. Agranulocytosis has also been reported.

Possible risk factors for leukopenia/neutropenia include pre-existing low white blood cell count (WBC) and a history of drug-induced leukopenia/neutropenia. Patients with a history of a clinically significant low WBC or a drug-induced leukopenia/neutropenia should have their complete blood count (CBC) monitored frequently during the first few months of therapy and discontinuation of RISPERDAL CONSTA[®] should be considered at the first sign of a clinically significant decline in WBC in the absence of other causative factors.

Patients with clinically significant neutropenia should be carefully monitored for fever or other symptoms or signs of infection and treated promptly if such symptoms or signs occur. Patients with severe neutropenia (absolute neutrophil count <1000/mm³) should discontinue RISPERDAL CONSTA[®] and have their WBC followed until recovery.

5.9 Potential for Cognitive and Motor Impairment

Somnolence was reported by 5% of patients treated with RISPERDAL CONSTA[®] in multiple-dose trials. Since risperidone has the potential to impair judgment, thinking, or motor skills, patients should be cautioned about operating hazardous machinery, including automobiles, until they are reasonably certain that treatment with RISPERDAL CONSTA[®] does not affect them adversely.

5.10 Seizures

During premarketing testing, seizures occurred in 0.3% (5/1499 patients) of patients treated with RISPERDAL CONSTA[®]. Therefore, RISPERDAL CONSTA[®] should be used cautiously in patients with a history of seizures.

5.11 Dysphagia

Esophageal dysmotility and aspiration have been associated with antipsychotic drug use. Aspiration pneumonia is a common cause of morbidity and mortality in patients with advanced Alzheimer's dementia. RISPERDAL CONSTA[®] and other antipsychotic drugs should be used cautiously in patients at risk for aspiration pneumonia. *[see also Boxed Warning and Warnings and Precautions (5.1)]*

5.12 Priapism

Priapism has been reported during postmarketing surveillance *[see Adverse Reactions (6.8)]*. Severe priapism may require surgical intervention.

5.13 Thrombotic Thrombocytopenic Purpura (TTP)

A single case of TTP was reported in a 28 year-old female patient receiving oral RISPERDAL[®] in a large, open premarketing experience (approximately 1300 patients). She experienced jaundice, fever, and bruising, but eventually recovered after receiving plasmapheresis. The relationship to RISPERDAL[®] therapy is unknown.

5.14 Body Temperature Regulation

Disruption of body temperature regulation has been attributed to antipsychotic agents. Both hyperthermia and hypothermia have been reported in association with oral RISPERDAL[®] or RISPERDAL CONSTA[®] use. Caution is advised when prescribing RISPERDAL CONSTA[®] for patients who will be exposed to temperature extremes.

5.15 Administration

RISPERDAL CONSTA[®] should be injected into the deltoid or gluteal muscle, and care must be taken to avoid inadvertent injection into a blood vessel. *[see Dosage and Administration (2) and Adverse Reactions (6.7)]*

5.16 Antiemetic Effect

Risperidone has an antiemetic effect in animals; this effect may also occur in humans, and may mask signs and symptoms of overdosage with certain drugs or of conditions such as intestinal obstruction, Reye's syndrome, and brain tumor.

5.17 Suicide

There is an increased risk of suicide attempt in patients with schizophrenia or bipolar disorder, and close supervision of high-risk patients should accompany drug therapy. RISPERDAL CONSTA[®] is to be administered by a health care professional [*see Dosage and Administration (2)*]; therefore, suicide due to an overdose is unlikely.

5.18 Use in Patients with Concomitant Illness

Clinical experience with RISPERDAL CONSTA[®] in patients with certain concomitant systemic illnesses is limited. Patients with Parkinson's Disease or Dementia with Lewy Bodies who receive antipsychotics, including RISPERDAL CONSTA[®], are reported to have an increased sensitivity to antipsychotic medications. Manifestations of this increased sensitivity have been reported to include confusion, obtundation, postural instability with frequent falls, extrapyramidal symptoms, and clinical features consistent with the neuroleptic malignant syndrome.

Caution is advisable when using RISPERDAL CONSTA[®] in patients with diseases or conditions that could affect metabolism or hemodynamic responses. RISPERDAL CONSTA[®] has not been evaluated or used to any appreciable extent in patients with a recent history of myocardial infarction or unstable heart disease. Patients with these diagnoses were excluded from clinical studies during the product's premarket testing.

Increased plasma concentrations of risperidone and 9-hydroxyrisperidone occur in patients with severe renal impairment (creatinine clearance <30 mL/min/1.73 m²) treated with oral RISPERDAL[®]; an increase in the free fraction of risperidone is also seen in patients with severe hepatic impairment. Patients with renal or hepatic impairment should be carefully titrated on oral RISPERDAL[®] before treatment with RISPERDAL CONSTA[®] is initiated at a dose of 25 mg. A lower initial dose of 12.5 mg may be appropriate when clinical factors warrant dose adjustment, such as in patients with renal or hepatic impairment [*see Dosage and Administration (2.4)*].

5.19 Osteodystrophy and Tumors in Animals

RISPERDAL CONSTA[®] produced osteodystrophy in male and female rats in a 1-year toxicity study and a 2-year carcinogenicity study at a dose of 40 mg/kg administered IM every 2 weeks.

RISPERDAL CONSTA[®] produced renal tubular tumors (adenoma, adenocarcinoma) and adrenomedullary pheochromocytomas in male rats in the 2-year carcinogenicity study at 40 mg/kg administered IM every 2 weeks. In addition, RISPERDAL CONSTA[®] produced an increase in a marker of cellular proliferation in renal tissue in males in the 1-year toxicity study and in renal tumor-bearing males in the 2-year carcinogenicity study at 40 mg/kg administered IM every 2 weeks. (Cellular proliferation was not measured at the low dose or in females in either study.)

The effect dose for osteodystrophy and the tumor findings is 8 times the IM maximum recommended human dose (MRHD) (50 mg) on a mg/m² basis and is associated with a plasma exposure (AUC) 2 times the expected plasma exposure (AUC) at the IM MRHD. The no-effect dose for these findings was 5 mg/kg (equal to the IM MRHD on a mg/m² basis). Plasma exposure (AUC) at the no-effect dose was one third the expected plasma exposure (AUC) at the IM MRHD.

Neither the renal or adrenal tumors, nor osteodystrophy, were seen in studies of orally administered risperidone. Osteodystrophy was not observed in dogs at doses up to 14 times (based on AUC) the IM MRHD in a 1-year toxicity study.

The renal tubular and adrenomedullary tumors in male rats and other tumor findings are described in more detail in Section 13.1 (Carcinogenicity, Mutagenesis, Impairment of Fertility).

The relevance of these findings to human risk is unknown.

5.20 Monitoring: Laboratory Tests

No specific laboratory tests are recommended.

6 ADVERSE REACTIONS

The following are discussed in more detail in other sections of the labeling:

- Increased mortality in elderly patients with dementia-related psychosis [*see Boxed Warning and Warnings and Precautions (5.1)*]
- Cerebrovascular adverse events, including stroke, in elderly patients with dementia-related psychosis [*see Warnings and Precautions (5.2)*]
- Neuroleptic malignant syndrome [*see Warnings and Precautions (5.3)*]
- Tardive dyskinesia [*see Warnings and Precautions (5.4)*]
- Metabolic changes [*see Warnings and Precautions (5.5)*]
- Hyperprolactinemia [*see Warnings and Precautions (5.6)*]
- Orthostatic hypotension [*see Warnings and Precautions (5.7)*]

- Leukopenia/Neutropenia and Agranulocytosis [*see Warnings and Precautions (5.8)*]
- Potential for cognitive and motor impairment [*see Warnings and Precautions (5.9)*]
- Seizures [*see Warnings and Precautions (5.10)*]
- Dysphagia [*see Warnings and Precautions (5.11)*]
- Priapism [*see Warnings and Precautions (5.12)*]
- Thrombotic Thrombocytopenic Purpura (TTP) [*see Warnings and Precautions (5.13)*]
- Disruption of body temperature regulation [*see Warnings and Precautions (5.14)*]
- Avoidance of inadvertent injection into a blood vessel [*see Warnings and Precautions (5.15)*]
- Antiemetic effect [*see Warnings and Precautions (5.16)*]
- Suicide [*see Warnings and Precautions (5.17)*]
- Increased sensitivity in patients with Parkinson's disease or those with dementia with Lewy bodies [*see Warnings and Precautions (5.18)*]
- Diseases or conditions that could affect metabolism or hemodynamic responses [*see Warnings and Precautions (5.18)*]
- Osteodystrophy and tumors in animals [*see Warnings and Precautions (5.19)*]

The most common adverse reactions in clinical trials in patients with schizophrenia ($\geq 5\%$) were: headache, parkinsonism, dizziness, akathisia, fatigue, constipation, dyspepsia, sedation, weight increased, pain in extremity, and dry mouth. The most common adverse reactions in the double-blind, placebo-controlled periods of the bipolar disorder trials were weight increased (5% in the monotherapy trial) and tremor and parkinsonism ($\geq 10\%$ in the adjunctive treatment trial).

The most common adverse reactions that were associated with discontinuation from the 12-week double-blind, placebo-controlled trial in patients with schizophrenia (causing discontinuation in $\geq 1\%$ of patients) were agitation, depression, anxiety, and akathisia. Adverse reactions that were associated with discontinuation from the double-blind, placebo-controlled periods of the bipolar disorder trials were hyperglycemia (one patient in the monotherapy trial) and hypokinesia and tardive dyskinesia (one patient each in the adjunctive treatment trial).

The data described in this section are derived from a clinical trial database consisting of 2392 patients exposed to one or more doses of RISPERDAL CONSTA[®] for the treatment of schizophrenia. Of these 2392 patients, 332 were patients who received RISPERDAL CONSTA[®] while participating in a 12-week double-blind, placebo-controlled trial. Two hundred two (202) of the 332 were schizophrenia patients who received 25 mg or 50 mg RISPERDAL CONSTA[®]. The conditions and duration of treatment with RISPERDAL CONSTA[®] in the other clinical trials varied greatly and included (in overlapping categories) double-blind, fixed- and flexible-

dose, placebo- or active-controlled studies and open-label phases of studies, inpatients and outpatients, and short-term (up to 12 weeks) and longer-term (up to 4 years) exposures. Safety was assessed by collecting adverse events and performing physical examinations, vital signs, body weights, laboratory analyses, and ECGs.

In addition to the studies in patients with schizophrenia, safety data are presented from a trial assessing the efficacy and safety of RISPERDAL CONSTA[®] when administered as monotherapy for maintenance treatment in patients with bipolar I disorder. The subjects in this multi-center, double-blind, placebo-controlled study were adult patients who met DSM-IV criteria for Bipolar Disorder Type I and who were stable on risperidone (oral or long-acting injection), were stable on other antipsychotics or mood stabilizers, or were experiencing an acute episode. After a 3-week period of treatment with open-label oral risperidone (N=440), subjects who demonstrated an initial response to oral risperidone in this period and those who were stable on risperidone (oral or long-acting injection) at study entry entered into a 26-week stabilization period of open-label RISPERDAL CONSTA[®] (N=501). Subjects who demonstrated a maintained response during this period were then randomized into a 24-month double-blind, placebo-controlled period in which they received RISPERDAL CONSTA[®] (N=154) or placebo (N=149) as monotherapy. Subjects who relapsed or who completed the double-blind period could choose to enter an 8-week open-label RISPERDAL CONSTA[®] extension period (N=160).

Safety data are also presented from a trial assessing the efficacy and safety of RISPERDAL CONSTA[®] when administered as adjunctive maintenance treatment in patients with bipolar disorder. The subjects in this multi-center, double-blind, placebo-controlled study were adult patients who met DSM-IV criteria for Bipolar Disorder Type I or Type II and who experienced at least 4 episodes of mood disorder requiring psychiatric/clinical intervention in the previous 12 months, including at least 2 episodes in the 6 months prior to the start of the study. At the start of this study, all patients (N=275) entered into a 16-week open-label treatment phase in which they received RISPERDAL CONSTA[®] in addition to continuing their treatment as usual, which consisted of various mood stabilizers (primarily lithium and valproate), antidepressants, and/or anxiolytics. Patients who reached remission at the end of this 16-week open-label treatment phase (N=139) were then randomized into a 52-week double-blind, placebo-controlled phase in which they received RISPERDAL CONSTA[®] (N=72) or placebo (n=67) as adjunctive treatment in addition to continuing their treatment as usual. Patients who did not reach remission at the end of the 16-week open-label treatment phase could choose to continue to receive RISPERDAL CONSTA[®] as adjunctive therapy in an open-label manner, in addition to continuing their treatment as usual, for up to an additional 36 weeks as clinically indicated for a total period of up to 52 weeks; these patients (N=70) were also included in the evaluation of safety.

Adverse events during exposure to study treatment were obtained by general inquiry and recorded by clinical investigators using their own terminology. Consequently, to provide a meaningful estimate of the proportion of individuals experiencing adverse events, events were grouped in standardized categories using MedDRA terminology.

Throughout this section, adverse reactions are reported. Adverse reactions are adverse events that were considered to be reasonably associated with the use of RISPERDAL CONSTA[®] (adverse drug reactions) based on the comprehensive assessment of the available adverse event information. A causal association for RISPERDAL CONSTA[®] often cannot be reliably established in individual cases. Further, because clinical trials are conducted under widely varying conditions, adverse reaction rates observed in the clinical trials of a drug cannot be directly compared to rates in the clinical trials of another drug and may not reflect the rates observed in clinical practice.

The majority of all adverse reactions were mild to moderate in severity.

6.1 Commonly-Observed Adverse Reactions in Double-Blind, Placebo-Controlled Clinical Trials - Schizophrenia

Table 4 lists the adverse reactions reported in 2% or more of RISPERDAL CONSTA[®]-treated patients with schizophrenia in one 12-week double-blind, placebo-controlled trial.

Table 4. Adverse Reactions in $\geq 2\%$ of RISPERDAL CONSTA[®]-Treated Patients with Schizophrenia in a 12-Week Double-Blind, Placebo-Controlled Trial

System/Organ Class Adverse Reaction	Percentage of Patients Reporting Event		
	RISPERDAL CONSTA [®] 25 mg (N=99)	50 mg (N=103)	Placebo (N=98)
Eye disorders			
Vision blurred	2	3	0
Gastrointestinal disorders			
Constipation	5	7	1
Dry mouth	0	7	1
Dyspepsia	6	6	0
Nausea	3	4	5
Toothache	1	3	0
Salivary hypersecretion	4	1	0
General disorders and administration site conditions			
Fatigue*	3	9	0
Edema peripheral	2	3	1
Pain	4	1	0
Pyrexia	2	1	0
Infections and infestations			
Upper respiratory tract infection	2	0	1
Investigations			
Weight increased	5	4	2
Weight decreased	4	1	1
Musculoskeletal and connective tissue disorders			
Pain in extremity	6	2	1
Nervous system disorders			
Headache	15	21	12
Parkinsonism*	8	15	9
Dizziness	7	11	6
Akathisia*	4	11	6
Sedation*	5	6	3
Tremor	0	3	0
Syncope	2	1	0
Hypoesthesia	2	0	0
Respiratory, thoracic and mediastinal disorders			
Cough	4	2	3
Sinus congestion	2	0	0
Skin and subcutaneous tissue disorders			
Acne	2	2	0
Dry skin	2	0	0

* Fatigue includes fatigue and asthenia. Parkinsonism includes extrapyramidal disorder, musculoskeletal stiffness, muscle rigidity, and bradykinesia. Akathisia includes akathisia and restlessness. Sedation includes sedation and somnolence.

6.2 Commonly-Observed Adverse Reactions in Double-Blind, Placebo-Controlled Clinical Trials – Bipolar Disorder

Table 5 lists the treatment-emergent adverse reactions reported in 2% or more of RISPERDAL CONSTA[®]-treated patients in the 24-month double-blind, placebo-controlled treatment period of the trial assessing the efficacy and safety of RISPERDAL CONSTA[®] when administered as monotherapy for maintenance treatment in patients with Bipolar I Disorder.

Table 5. Adverse Reactions in $\geq 2\%$ of Patients with Bipolar I Disorder Treated with RISPERDAL CONSTA[®] as Monotherapy in a 24-Month Double-Blind, Placebo-Controlled Trial

System/Organ Class Adverse Reaction	Percentage of Patients Reporting Event	
	RISPERDAL CONSTA [®] (N=154)	Placebo (N=149)
Investigations		
Weight increased	5	1
Nervous system disorders		
Dizziness	3	1
Vascular disorders		
Hypertension	3	1

Table 6 lists the treatment-emergent adverse reactions reported in 4% or more of patients in the 52-week double-blind, placebo-controlled treatment phase of a trial assessing the efficacy and safety of RISPERDAL CONSTA[®] when administered as adjunctive maintenance treatment in patients with bipolar disorder.

Table 6. Adverse Reactions in $\geq 4\%$ of Patients with Bipolar Disorder Treated with RISPERDAL CONSTA[®] as Adjunctive Therapy in a 52-Week Double-Blind, Placebo-Controlled Trial

System/Organ Class Adverse Reaction	Percentage of Patients Reporting Event	
	RISPERDAL CONSTA [®] + Treatment as Usual ^a (N=72)	Placebo + Treatment as Usual ^a (N=67)
General disorders and administration site conditions		
Gait abnormal	4	0
Infections and infestations		
Upper respiratory tract infection	6	3
Investigations		
Weight increased	7	1
Metabolism and nutrition disorders		
Decreased appetite	6	1
Increased appetite	4	0
Musculoskeletal and connective tissue disorders		
Arthralgia	4	3
Nervous system disorders		
Tremor	24	16
Parkinsonism ^b	15	6
Dyskinesia ^b	6	3
Sedation ^c	7	1
Disturbance in attention	4	0
Reproductive system and breast disorders		
Amenorrhea	4	1
Respiratory, thoracic and mediastinal disorders		
Cough	4	1

^a Patients received double-blind RISPERDAL CONSTA[®] or placebo in addition to continuing their treatment as usual, which included mood stabilizers, antidepressants, and/or anxiolytics.

^b Parkinsonism includes muscle rigidity, hypokinesia, cogwheel rigidity, and bradykinesia. Dyskinesia includes muscle twitching and dyskinesia.

^c Sedation includes sedation and somnolence.

6.3 Other Adverse Reactions Observed During the Clinical Trial Evaluation of Risperidone

The following additional adverse reactions occurred in $< 2\%$ of the RISPERDAL CONSTA[®]-treated patients in the above schizophrenia double-blind, placebo-controlled trial dataset, in $< 2\%$ of the RISPERDAL CONSTA[®]-treated patients in the above double-blind, placebo-controlled period of the monotherapy bipolar disorder trial dataset, or in $< 4\%$ of the RISPERDAL CONSTA[®]-treated patients in the above double-blind, placebo-controlled period of the adjunctive treatment bipolar disorder trial dataset. The following also includes additional adverse reactions reported at any frequency in RISPERDAL CONSTA[®]-treated patients who participated in the open-label phases of the above bipolar disorder studies and in other studies, including double-blind, active controlled and open-label studies in schizophrenia and bipolar disorder.

Blood and lymphatic system disorders: anemia, neutropenia

Cardiac disorders: tachycardia, atrioventricular block first degree, palpitations, sinus bradycardia, bundle branch block left, bradycardia, sinus tachycardia, bundle branch block right

Ear and labyrinth disorders: ear pain, vertigo

Endocrine disorders: hyperprolactinemia

Eye disorders: conjunctivitis, visual acuity reduced

Gastrointestinal disorders: diarrhea, vomiting, abdominal pain upper, abdominal pain, stomach discomfort, gastritis

General disorders and administration site conditions: injection site pain, chest discomfort, chest pain, influenza like illness, sluggishness, malaise, induration, injection site induration, injection site swelling, injection site reaction, face edema

Immune system disorders: hypersensitivity

Infections and infestations: nasopharyngitis, influenza, bronchitis, urinary tract infection, rhinitis, respiratory tract infection, ear infection, pneumonia, lower respiratory tract infection, pharyngitis, sinusitis, viral infection, infection, localized infection, cystitis, gastroenteritis, subcutaneous abscess

Injury and poisoning: fall, procedural pain

Investigations: blood prolactin increased, alanine aminotransferase increased, electrocardiogram abnormal, gamma-glutamyl transferase increased, blood glucose increased, hepatic enzyme increased, aspartate aminotransferase increased, electrocardiogram QT prolonged, glucose urine present

Metabolism and nutritional disorders: anorexia, hyperglycemia

Musculoskeletal, connective tissue and bone disorders: posture abnormal, myalgia, back pain, buttock pain, muscular weakness, neck pain, musculoskeletal chest pain

Nervous system disorders: coordination abnormal, dystonia, tardive dyskinesia, drooling, paresthesia, dizziness postural, convulsion, akinesia, hypokinesia, dysarthria

Psychiatric disorders: insomnia, agitation, anxiety, sleep disorder, depression, initial insomnia, libido decreased, nervousness

Renal and urinary disorders: urinary incontinence

Reproductive system and breast disorders: galactorrhea, oligomenorrhea, erectile dysfunction, sexual dysfunction, ejaculation disorder, gynecomastia, breast discomfort, menstruation irregular, menstruation delayed, menstrual disorder, ejaculation delayed

Respiratory, thoracic and mediastinal disorders: nasal congestion, pharyngolaryngeal pain, dyspnea, rhinorrhea

Skin and subcutaneous tissue disorders: rash, eczema, pruritus generalized, pruritus

Vascular disorders: hypotension, orthostatic hypotension

Additional Adverse Reactions Reported with Oral RISPERDAL[®]

The following is a list of additional adverse reactions that have been reported during the clinical trial evaluation of oral RISPERDAL[®], regardless of frequency of occurrence:

Blood and Lymphatic Disorders: granulocytopenia

Cardiac Disorders: atrioventricular block

Ear and Labyrinth Disorders: tinnitus

Eye Disorders: ocular hyperemia, eye discharge, eye rolling, eyelid edema, eye swelling, eyelid margin crusting, dry eye, lacrimation increased, photophobia, glaucoma

Gastrointestinal Disorders: abdominal pain upper, dysphagia, fecaloma, abdominal discomfort, fecal incontinence, lip swelling, cheilitis, apthalism

General Disorders: thirst, feeling abnormal, gait disturbance, pitting edema, edema, chills, discomfort, generalized edema, drug withdrawal syndrome, peripheral coldness

Immune System Disorders: drug hypersensitivity

Infections and Infestations: tonsillitis, eye infection, cellulitis, otitis media, onychomycosis, acarodermatitis, bronchopneumonia, respiratory tract infection, tracheobronchitis, otitis media chronic

Investigations: body temperature increased, heart rate increased, eosinophil count increased, white blood cell count decreased, hemoglobin decreased, blood creatine phosphokinase increased, hematocrit decreased, body temperature decreased, blood pressure decreased, transaminases increased

Metabolism and Nutrition Disorders: polydipsia

Musculoskeletal, Connective Tissue, and Bone Disorders: joint swelling, joint stiffness, rhabdomyolysis, torticollis

Nervous System Disorders: hypertonia, balance disorder, dysarthria, unresponsive to stimuli, depressed level of consciousness, movement disorder, hypokinesia, parkinsonian rest tremor, transient ischemic attack, cerebrovascular accident, masked facies, speech disorder, loss of consciousness, muscle contractions involuntary, akinesia, cerebral ischemia, cerebrovascular disorder, neuroleptic malignant syndrome, diabetic coma, head titubation

Psychiatric Disorders: blunted affect, confusional state, middle insomnia, listlessness, anorgasmia

Renal and Urinary Disorders: enuresis, dysuria, pollakiuria

Reproductive System and Breast Disorders: vaginal discharge, retrograde ejaculation, ejaculation disorder, ejaculation failure, breast enlargement

Respiratory, Thoracic, and Mediastinal Disorders: epistaxis, wheezing, pneumonia aspiration, dysphonia, productive cough, pulmonary congestion, respiratory tract congestion, rales, respiratory disorder, hyperventilation, nasal edema

Skin and Subcutaneous Tissue Disorders: erythema, skin discoloration, skin lesion, skin disorder, rash erythematous, rash papular, hyperkeratosis, dandruff, seborrheic dermatitis, rash generalized, rash maculopapular

Vascular Disorders: flushing

6.4 Discontinuations Due to Adverse Reactions

Schizophrenia

Approximately 11% (22/202) of RISPERDAL CONSTA[®]-treated patients in the 12-week double-blind, placebo-controlled schizophrenia trial discontinued treatment due to an adverse event, compared with 13% (13/98) who received placebo. The adverse reactions associated with discontinuation in two or more RISPERDAL CONSTA[®]-treated patients were: agitation (3%), depression (2%), anxiety (1%), and akathisia (1%).

Bipolar Disorder

In the 24-month double-blind, placebo-controlled treatment period of the trial assessing the efficacy and safety of RISPERDAL CONSTA[®] when administered as monotherapy for maintenance treatment in patients with bipolar I disorder, 1 (0.6%) of 154 RISPERDAL CONSTA[®]-treated patients discontinued due to an adverse reaction (hyperglycemia).

In the 52-week double-blind phase of the placebo-controlled trial in which RISPERDAL CONSTA[®] was administered as adjunctive therapy to patients with bipolar disorder in addition to continuing with their treatment as usual, approximately 4% (3/72) of RISPERDAL CONSTA[®]-treated patients discontinued treatment due to an adverse event, compared with 1.5% (1/67) of placebo-treated patients. Adverse reactions associated with discontinuation in RISPERDAL CONSTA[®]-treated patients were: hypokinesia (one patient) and tardive dyskinesia (one patient).

6.5 Dose Dependency of Adverse Reactions in Clinical Trials

Extrapyramidal Symptoms:

Two methods were used to measure extrapyramidal symptoms (EPS) in the 12-week double-blind, placebo-controlled trial comparing three doses of RISPERDAL CONSTA[®] (25 mg, 50 mg, and 75 mg) with placebo in patients with schizophrenia, including: (1) the incidence of spontaneous reports of EPS symptoms; and (2) the change from baseline to endpoint on the total score (sum of the subscale scores for parkinsonism, dystonia, and dyskinesia) of the Extrapyramidal Symptom Rating Scale (ESRS).

As shown in Table 1, the overall incidence of EPS-related adverse reactions (akathisia, dystonia, parkinsonism, and tremor) in patients treated with 25 mg RISPERDAL CONSTA[®] was comparable to that of patients treated with placebo; the incidence of EPS-related adverse reactions was higher in patients treated with 50 mg RISPERDAL CONSTA[®].

The median change from baseline to endpoint in total ESRS score showed no worsening in patients treated with RISPERDAL CONSTA[®] compared with patients treated with placebo: 0 (placebo group); -1 (25-mg group, significantly less than the placebo group); and 0 (50-mg group).

Dystonia

Class Effect: Symptoms of dystonia, prolonged abnormal contractions of muscle groups, may occur in susceptible individuals during the first few days of treatment. Dystonic symptoms include: spasm of the neck muscles, sometimes progressing to tightness of the throat, swallowing difficulty, difficulty breathing, and/or protrusion of the tongue. While these symptoms can occur at low doses, they occur more frequently and with greater severity with high potency and at higher doses of first generation antipsychotic drugs. An elevated risk of acute dystonia is observed in males and younger age groups.

6.6 Changes in ECG

The electrocardiograms of 202 schizophrenic patients treated with 25 mg or 50 mg RISPERDAL CONSTA[®] and 98 schizophrenic patients treated with placebo in the 12-week double-blind,

placebo-controlled trial were evaluated. Compared with placebo, there were no statistically significant differences in QTc intervals (using Fridericia's and linear correction factors) during treatment with RISPERDAL CONSTA[®].

The electrocardiograms of 227 patients with Bipolar I Disorder were evaluated in the 24-month double-blind, placebo-controlled period. There were no clinically relevant differences in QTc intervals (using Fridericia's and linear correction factors) during treatment with RISPERDAL CONSTA[®] compared to placebo.

The electrocardiograms of 85 patients with bipolar disorder were evaluated in the 52-week double-blind, placebo-controlled trial. There were no statistically significant differences in QTc intervals (using Fridericia's and linear correction factors) during treatment with RISPERDAL CONSTA[®] 25 mg, 37.5 mg, or 50 mg when administered as adjunctive treatment in addition to continuing treatment as usual compared to placebo.

6.7 Pain Assessment and Local Injection Site Reactions

The mean intensity of injection pain reported by patients with schizophrenia using a visual analog scale (0 = no pain to 100 = unbearably painful) decreased in all treatment groups from the first to the last injection (placebo: 16.7 to 12.6; 25 mg: 12.0 to 9.0; 50 mg: 18.2 to 11.8). After the sixth injection (Week 10), investigator ratings indicated that 1% of patients treated with 25 mg or 50 mg RISPERDAL CONSTA[®] experienced redness, swelling, or induration at the injection site.

In a separate study to observe local-site tolerability in which RISPERDAL CONSTA[®] was administered into the deltoid muscle every 2 weeks over a period of 8 weeks, no patient discontinued treatment due to local injection site pain or reaction. Clinician ratings indicated that only mild redness, swelling, or induration at the injection site was observed in subjects treated with 37.5 mg or 50 mg RISPERDAL CONSTA[®] at 2 hours after deltoid injection. All ratings returned to baseline at the predose assessment of the next injection 2 weeks later. No moderate or severe reactions were observed in any subject.

6.8 Postmarketing Experience

The following adverse reactions have been identified during postapproval use of risperidone; because these reactions are reported voluntarily from a population of uncertain size, it is not possible to reliably estimate their frequency: agranulocytosis, alopecia, anaphylactic reaction, angioedema, atrial fibrillation, blood cholesterol increased, blood triglycerides increased, diabetes mellitus, diabetic ketoacidosis in patients with impaired glucose metabolism, drug withdrawal syndrome neonatal, dysgeusia, hypoglycemia, hypothermia, ileus, inappropriate antidiuretic hormone secretion, intestinal obstruction, jaundice, mania, pancreatitis, priapism, QT

prolongation, sleep apnea syndrome, thrombocytopenia, urinary retention, and water intoxication. In addition, the following adverse reactions have been observed during postapproval use of RISPERDAL CONSTA[®]: cerebrovascular disorders, including cerebrovascular accidents, and diabetes mellitus aggravated.

Retinal artery occlusion after injection of RISPERDAL CONSTA[®] has been reported during postmarketing surveillance. This has been reported in the presence of abnormal arteriovenous anastomosis.

Serious injection site reactions including abscess, cellulitis, cyst, hematoma, necrosis, nodule, and ulcer have been reported with RISPERDAL CONSTA[®] during postmarketing surveillance. Isolated cases required surgical intervention.

Very rarely, cases of anaphylactic reaction after injection with RISPERDAL CONSTA[®] have been reported during postmarketing experience in patients who have previously tolerated oral risperidone.

7 DRUG INTERACTIONS

The interactions of RISPERDAL CONSTA[®] with coadministration of other drugs have not been systematically evaluated. The drug interaction data provided in this section is based on studies with oral RISPERDAL[®].

7.1 Centrally-Acting Drugs and Alcohol

Given the primary CNS effects of risperidone, caution should be used when RISPERDAL CONSTA[®] is administered in combination with other centrally-acting drugs or alcohol.

7.2 Drugs with Hypotensive Effects

Because of its potential for inducing hypotension, RISPERDAL CONSTA[®] may enhance the hypotensive effects of other therapeutic agents with this potential.

7.3 Levodopa and Dopamine Agonists

RISPERDAL CONSTA[®] may antagonize the effects of levodopa and dopamine agonists.

7.4 Amitriptyline

Amitriptyline did not affect the pharmacokinetics of risperidone or of risperidone and 9-hydroxyrisperidone combined following concomitant administration with oral RISPERDAL[®].

7.5 Cimetidine and Ranitidine

Cimetidine and ranitidine increased the bioavailability of oral risperidone by 64% and 26%, respectively. However, cimetidine did not affect the AUC of risperidone and

9-hydroxyrisperidone combined, whereas ranitidine increased the AUC of risperidone and 9-hydroxyrisperidone combined by 20%.

7.6 Clozapine

Chronic administration of clozapine with risperidone may decrease the clearance of risperidone.

7.7 Lithium

Repeated doses of oral RISPERDAL[®] (3 mg twice daily) did not affect the exposure (AUC) or peak plasma concentrations (C_{max}) of lithium (N=13).

7.8 Valproate

Repeated doses of oral RISPERDAL[®] (4 mg once daily) did not affect the pre-dose or average plasma concentrations and exposure (AUC) of valproate (1000 mg/day in three divided doses) compared to placebo (N=21). However, there was a 20% increase in valproate peak plasma concentration (C_{max}) after concomitant administration of oral RISPERDAL[®].

7.9 Digoxin

Oral RISPERDAL[®] (0.25 mg twice daily) did not show a clinically relevant effect on the pharmacokinetics of digoxin.

7.10 Topiramate

Oral RISPERDAL[®] administered at doses from 1-6 mg/day concomitantly with topiramate 400 mg/day resulted in a 23% decrease in risperidone C_{max} and a 33% decrease in risperidone $AUC_{0-12 \text{ hour}}$ at steady state. Minimal reductions in the exposure to risperidone and 9-hydroxyrisperidone combined, and no change for 9-hydroxyrisperidone were observed. This interaction is unlikely to be of clinical significance. There was no clinically relevant effect of oral RISPERDAL[®] on the pharmacokinetics of topiramate.

7.11 Drugs That Inhibit CYP 2D6 and Other CYP Isozymes

Risperidone is metabolized to 9-hydroxyrisperidone by CYP 2D6, an enzyme that is polymorphic in the population and that can be inhibited by a variety of psychotropic and other drugs [see *Clinical Pharmacology (12.3)*]. Drug interactions that reduce the metabolism of risperidone to 9-hydroxyrisperidone would increase the plasma concentrations of risperidone and lower the concentrations of 9-hydroxyrisperidone. Analysis of clinical studies involving a modest number of poor metabolizers (n \cong 70 patients) does not suggest that poor and extensive metabolizers have different rates of adverse effects. No comparison of effectiveness in the two groups has been made.

In vitro studies showed that drugs metabolized by other CYP isozymes, including 1A1, 1A2, 2C9, 2C19, and 3A4, are only weak inhibitors of risperidone metabolism.

Fluoxetine and Paroxetine

Fluoxetine (20 mg once daily) and paroxetine (20 mg once daily), CYP 2D6 inhibitors, have been shown to increase the plasma concentration of risperidone 2.5-2.8 fold and 3-9 fold respectively. Fluoxetine did not affect the plasma concentration of 9-hydroxyrisperidone. Paroxetine lowered the concentration of 9-hydroxyrisperidone by about 10%. When either concomitant fluoxetine or paroxetine is initiated or discontinued, the physician should re-evaluate the dose of RISPERDAL CONSTA[®]. When initiation of fluoxetine or paroxetine is considered, patients may be placed on a lower dose of RISPERDAL CONSTA[®] between 2 to 4 weeks before the planned start of fluoxetine or paroxetine therapy to adjust for the expected increase in plasma concentrations of risperidone. When fluoxetine or paroxetine is initiated in patients receiving the recommended dose of 25 mg RISPERDAL CONSTA[®], it is recommended to continue treatment with the 25-mg dose unless clinical judgment necessitates lowering the RISPERDAL CONSTA[®] dose to 12.5 mg or necessitates interruption of RISPERDAL CONSTA[®] treatment. When RISPERDAL CONSTA[®] is initiated in patients already receiving fluoxetine or paroxetine, a starting dose of 12.5 mg can be considered. The efficacy of the 12.5 mg dose has not been investigated in clinical trials. [*see also Dosage and Administration (2.5)*]. The effects of discontinuation of concomitant fluoxetine or paroxetine therapy on the pharmacokinetics of risperidone and 9-hydroxyrisperidone have not been studied.

Erythromycin

There were no significant interactions between oral RISPERDAL[®] and erythromycin.

7.12 Carbamazepine and Other CYP 3A4 Enzyme Inducers

Carbamazepine co-administration with oral RISPERDAL[®] decreased the steady-state plasma concentrations of risperidone and 9-hydroxyrisperidone by about 50%. Plasma concentrations of carbamazepine did not appear to be affected. Co-administration of other known CYP 3A4 enzyme inducers (e.g., phenytoin, rifampin, and phenobarbital) with risperidone may cause similar decreases in the combined plasma concentrations of risperidone and 9-hydroxyrisperidone, which could lead to decreased efficacy of RISPERDAL CONSTA[®] treatment. At the initiation of therapy with carbamazepine or other known hepatic enzyme inducers, patients should be closely monitored during the first 4-8 weeks, since the dose of RISPERDAL CONSTA[®] may need to be adjusted. A dose increase, or additional oral RISPERDAL[®], may need to be considered. On discontinuation of carbamazepine or other CYP 3A4 hepatic enzyme inducers, the dosage of RISPERDAL CONSTA[®] should be re-evaluated and, if necessary, decreased. Patients may be placed on a lower dose of RISPERDAL CONSTA[®]

between 2 to 4 weeks before the planned discontinuation of carbamazepine or other CYP 3A4 enzyme inducers to adjust for the expected increase in plasma concentrations of risperidone plus 9-hydroxyrisperidone. For patients treated with the recommended dose of 25 mg RISPERDAL CONSTA[®] and discontinuing from carbamazepine or other CYP 3A4 enzyme inducers, it is recommended to continue treatment with the 25-mg dose unless clinical judgment necessitates lowering the RISPERDAL CONSTA[®] dose to 12.5 mg or necessitates interruption of RISPERDAL CONSTA[®] treatment. The efficacy of the 12.5 mg dose has not been investigated in clinical trials. [see also Dosage and Administration (2.5)]

7.13 Drugs Metabolized by CYP 2D6

In vitro studies indicate that risperidone is a relatively weak inhibitor of CYP 2D6. Therefore, RISPERDAL CONSTA[®] is not expected to substantially inhibit the clearance of drugs that are metabolized by this enzymatic pathway. In drug interaction studies, oral RISPERDAL[®] did not significantly affect the pharmacokinetics of donepezil and galantamine, which are metabolized by CYP 2D6.

8 USE IN SPECIFIC POPULATIONS

8.1 Pregnancy

Pregnancy Category C.

The teratogenic potential of oral risperidone was studied in three embryofetal development studies in Sprague-Dawley and Wistar rats (0.63-10 mg/kg or 0.4 to 6 times the oral maximum recommended human dose [MRHD] on a mg/m² basis) and in one embryofetal development study in New Zealand rabbits (0.31-5 mg/kg or 0.4 to 6 times the oral MRHD on a mg/m² basis). The incidence of malformations was not increased compared to control in offspring of rats or rabbits given 0.4 to 6 times the oral MRHD on a mg/m² basis. In three reproductive studies in rats (two peri/post-natal development studies and a multigenerational study), there was an increase in pup deaths during the first 4 days of lactation at doses of 0.16-5 mg/kg or 0.1 to 3 times the oral MRHD on a mg/m² basis. It is not known whether these deaths were due to a direct effect on the fetuses or pups or to effects on the dams.

There was no no-effect dose for increased rat pup mortality. In one peri/post-natal development study, there was an increase in stillborn rat pups at a dose of 2.5 mg/kg or 1.5 times the oral MRHD on a mg/m² basis. In a cross-fostering study in Wistar rats, toxic effects on the fetus or pups, as evidenced by a decrease in the number of live pups and an increase in the number of dead pups at birth (Day 0), and a decrease in birth weight in pups of drug-treated dams were observed. In addition, there was an increase in deaths by Day 1 among pups of drug-treated dams, regardless of whether or not the pups were cross-fostered. Risperidone also appeared to impair maternal behavior in that pup body weight gain and survival (from Days 1 to 4 of

lactation) were reduced in pups born to control but reared by drug-treated dams. These effects were all noted at the one dose of risperidone tested, i.e., 5 mg/kg or 3 times the oral MRHD on a mg/m² basis.

No studies were conducted with RISPERDAL CONSTA[®].

Placental transfer of risperidone occurs in rat pups. There are no adequate and well-controlled studies in pregnant women. However, there was one report of a case of agenesis of the corpus callosum in an infant exposed to risperidone *in utero*. The causal relationship to oral RISPERDAL[®] therapy is unknown.

Non-Teratogenic Effects

Neonates exposed to antipsychotic drugs (including RISPERDAL[®]) during the third trimester of pregnancy are at risk for extrapyramidal and/or withdrawal symptoms following delivery. There have been reports of agitation, hypertonia, hypotonia, tremor, somnolence, respiratory distress, and feeding disorder in these neonates. These complications have varied in severity; while in some cases symptoms have been self-limited, in other cases neonates have required intensive care unit support and prolonged hospitalization.

RISPERDAL CONSTA[®] should be used during pregnancy only if the potential benefit justifies the potential risk to the fetus.

8.2 Labor and Delivery

The effect of RISPERDAL CONSTA[®] on labor and delivery in humans is unknown.

8.3 Nursing Mothers

Risperidone and 9-hydroxyrisperidone are also excreted in human breast milk. Therefore, women should not breast-feed during treatment with RISPERDAL CONSTA[®] and for at least 12 weeks after the last injection.

8.4 Pediatric Use

RISPERDAL CONSTA[®] has not been studied in children younger than 18 years old. However, juvenile animal toxicology studies have been conducted with oral risperidone.

Juvenile dogs were treated for 40 weeks with oral risperidone doses of 0.31, 1.25, or 5 mg/kg/day. Decreased bone length and density were seen, with a no-effect dose of 0.31 mg/kg/day. This dose produced plasma levels (AUC) of risperidone plus its active metabolite paliperidone (9-hydroxy-risperidone) which were similar to those in children and adolescents receiving the maximum recommended human dose (MRHD) of 6 mg/day. In

addition, a delay in sexual maturation was seen at all doses in both males and females. The above effects showed little or no reversibility in females after a 12 week drug-free recovery period.

In a study in which juvenile rats were treated with oral risperidone from days 12 to 50 of age, a reversible impairment of performance in a test of learning and memory was seen, in females only, with a no-effect dose of 0.63 mg/kg/day. This dose produced plasma levels (AUC) of risperidone plus paliperidone about half those observed in humans at the MRHD. No other consistent effects on neurobehavioral or reproductive development were seen up to the highest testable dose (1.25 mg/kg/day). This dose produced plasma levels (AUC) of risperidone plus paliperidone which were about two thirds of those observed in humans at the MRHD.

The long-term effects of risperidone on growth and sexual maturation have not been fully evaluated in children and adolescents.

8.5 Geriatric Use

In an open-label study, 57 clinically stable, elderly patients (≥ 65 years old) with schizophrenia or schizoaffective disorder received RISPERDAL CONSTA[®] every 2 weeks for up to 12 months. In general, no differences in the tolerability of RISPERDAL CONSTA[®] were observed between otherwise healthy elderly and nonelderly patients. Therefore, dosing recommendations for otherwise healthy elderly patients are the same as for nonelderly patients. Because elderly patients exhibit a greater tendency to orthostatic hypotension than nonelderly patients, elderly patients should be instructed in nonpharmacologic interventions that help to reduce the occurrence of orthostatic hypotension (e.g., sitting on the edge of the bed for several minutes before attempting to stand in the morning and slowly rising from a seated position). In addition, monitoring of orthostatic vital signs should be considered in elderly patients for whom orthostatic hypotension is of concern [*see Warnings and Precautions (5.7)*].

Concomitant use with Furosemide in Elderly Patients with Dementia-Related Psychosis

In two of four placebo-controlled trials in elderly patients with dementia-related psychosis, a higher incidence of mortality was observed in patients treated with furosemide plus oral risperidone when compared to patients treated with oral risperidone alone or with oral placebo plus furosemide. No pathological mechanism has been identified to explain this finding, and no consistent pattern for cause of death was observed. An increase of mortality in elderly patients with dementia-related psychosis was seen with the use of oral risperidone regardless of concomitant use with furosemide. RISPERDAL CONSTA[®] is not approved for the treatment of patients with dementia-related psychosis. [*see Boxed Warning and Warnings and Precautions (5.1)*]

9 DRUG ABUSE AND DEPENDENCE

9.1 Controlled Substance

RISPERDAL CONSTA[®] (risperidone) is not a controlled substance.

9.2 Abuse

RISPERDAL CONSTA[®] has not been systematically studied in animals or humans for its potential for abuse. Because RISPERDAL CONSTA[®] is to be administered by health care professionals, the potential for misuse or abuse by patients is low.

9.3 Dependence

RISPERDAL CONSTA[®] has not been systematically studied in animals or humans for its potential for tolerance or physical dependence.

10 OVERDOSAGE

10.1 Human Experience

No cases of overdose were reported in premarketing studies with RISPERDAL CONSTA[®]. Because RISPERDAL CONSTA[®] is to be administered by health care professionals, the potential for overdose by patients is low.

In premarketing experience with oral RISPERDAL[®], there were eight reports of acute RISPERDAL[®] overdose, with estimated doses ranging from 20 to 300 mg and no fatalities. In general, reported signs and symptoms were those resulting from an exaggeration of the drug's known pharmacological effects, i.e., drowsiness and sedation, tachycardia and hypotension, and extrapyramidal symptoms. One case, involving an estimated overdose of 240 mg, was associated with hyponatremia, hypokalemia, prolonged QT, and widened QRS. Another case, involving an estimated overdose of 36 mg, was associated with a seizure.

Postmarketing experience with oral RISPERDAL[®] includes reports of acute overdose, with estimated doses of up to 360 mg. In general, the most frequently reported signs and symptoms are those resulting from an exaggeration of the drug's known pharmacological effects, i.e., drowsiness, sedation, tachycardia, hypotension, and extrapyramidal symptoms. Other adverse reactions reported since market introduction related to oral RISPERDAL[®] overdose include prolonged QT interval and convulsions. Torsade de pointes has been reported in association with combined overdose of oral RISPERDAL[®] and paroxetine.

10.2 Management of Overdosage

In case of acute overdose, establish and maintain an airway and ensure adequate oxygenation and ventilation. Cardiovascular monitoring should commence immediately and should include continuous electrocardiographic monitoring to detect possible arrhythmias. If antiarrhythmic

therapy is administered, disopyramide, procainamide, and quinidine carry a theoretical hazard of QT prolonging effects that might be additive to those of risperidone. Similarly, it is reasonable to expect that the alpha-blocking properties of bretylium might be additive to those of risperidone, resulting in problematic hypotension.

There is no specific antidote to risperidone. Therefore, appropriate supportive measures should be instituted. The possibility of multiple drug involvement should be considered. Hypotension and circulatory collapse should be treated with appropriate measures, such as intravenous fluids and/or sympathomimetic agents (epinephrine and dopamine should not be used, since beta stimulation may worsen hypotension in the setting of risperidone-induced alpha blockade). In cases of severe extrapyramidal symptoms, anticholinergic medication should be administered. Close medical supervision and monitoring should continue until the patient recovers.

11 DESCRIPTION

Risperidone is a psychotropic agent belonging to the chemical class of benzisoxazole derivatives. The chemical designation is 3-[2-[4-(6-fluoro-1,2-benzisoxazol-3-yl)-1-piperidiny]ethyl]-6,7,8,9-tetrahydro-2-methyl-4H-pyrido[1,2-a]pyrimidin-4-one. Its molecular formula is $C_{23}H_{27}FN_4O_2$ and its molecular weight is 410.49. The structural formula is:

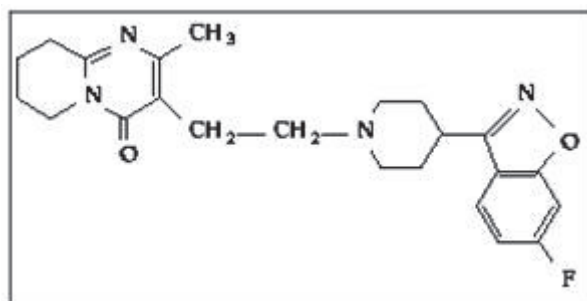

Risperidone is practically insoluble in water, freely soluble in methylene chloride, and soluble in methanol and 0.1 N HCl.

RISPERDAL CONSTA[®] (risperidone) Long-Acting Injection is a combination of extended-release microspheres for injection and diluent for parenteral use.

The extended-release microspheres formulation is a white to off-white, free-flowing powder that is available in dosage strengths of 12.5 mg, 25 mg, 37.5 mg, or 50 mg risperidone per vial. Risperidone is micro-encapsulated in 7525 polylactide-co-glycolide (PLG) at a concentration of 381 mg risperidone per gram of microspheres.

The diluent for parenteral use is a clear, colorless solution. Composition of the diluent includes citric acid anhydrous, disodium hydrogen phosphate dihydrate, polysorbate 20, sodium

carboxymethyl cellulose, sodium chloride, sodium hydroxide, and water for injection. The microspheres are suspended in the diluent prior to injection.

RISPERDAL CONSTA[®] is provided as a dose pack, consisting of a vial containing the microspheres, a pre-filled syringe containing the diluent, a West-Medimop Vial Adapter[®], and two Terumo SurGuard[®] 3 Needles (a 21 G UTW 1-inch needle with needle protection device for deltoid administration and a 20 G TW 2-inch needle with needle protection device for gluteal administration).

12 CLINICAL PHARMACOLOGY

12.1 Mechanism of Action

The mechanism of action of RISPERDAL CONSTA[®], as with other drugs used to treat schizophrenia, is unknown. However, it has been proposed that the drug's therapeutic activity in schizophrenia is mediated through a combination of dopamine Type 2 (D₂) and serotonin Type 2 (5HT₂) receptor antagonism.

RISPERDAL[®] is a selective monoaminergic antagonist with high affinity (K_i of 0.12 to 7.3 nM) for the serotonin Type 2 (5HT₂), dopamine Type 2 (D₂), α₁ and α₂ adrenergic, and H₁ histaminergic receptors. RISPERDAL[®] acts as an antagonist at other receptors, but with lower potency. RISPERDAL[®] has low to moderate affinity (K_i of 47 to 253 nM) for the serotonin 5HT_{1C}, 5HT_{1D}, and 5HT_{1A} receptors, weak affinity (K_i of 620 to 800 nM) for the dopamine D₁ and haloperidol-sensitive sigma site, and no affinity (when tested at concentrations >10⁻⁵ M) for cholinergic muscarinic or β₁ and β₂ adrenergic receptors.

12.2 Pharmacodynamics

The clinical effect from RISPERDAL CONSTA[®] results from the combined concentrations of risperidone and its major metabolite, 9-hydroxyrisperidone [*see Clinical Pharmacology (12.3)*]. Antagonism at receptors other than D₂ and 5HT₂ [*see Clinical Pharmacology (12.1)*] may explain some of the other effects of RISPERDAL CONSTA[®].

12.3 Pharmacokinetics

Absorption

After a single intramuscular (gluteal) injection of RISPERDAL CONSTA[®], there is a small initial release of the drug (< 1% of the dose), followed by a lag time of 3 weeks. The main release of the drug starts from 3 weeks onward, is maintained from 4 to 6 weeks, and subsides by 7 weeks following the intramuscular (IM) injection. Therefore, oral antipsychotic supplementation should be given during the first 3 weeks of treatment with RISPERDAL CONSTA[®] to maintain therapeutic levels until the main release of risperidone from the injection site has begun [*see Dosage and Administration (2)*]. Following single doses of RISPERDAL

CONSTA[®], the pharmacokinetics of risperidone, 9-hydroxyrisperidone (the major metabolite), and risperidone plus 9-hydroxyrisperidone were linear in the dosing range of 12.5 mg to 50 mg.

The combination of the release profile and the dosage regimen (IM injections every 2 weeks) of RISPERDAL CONSTA[®] results in sustained therapeutic concentrations. Steady-state plasma concentrations are reached after 4 injections and are maintained for 4 to 6 weeks after the last injection. Following multiple doses of 25 mg and 50 mg RISPERDAL CONSTA[®], plasma concentrations of risperidone, 9-hydroxyrisperidone, and risperidone plus 9-hydroxyrisperidone were linear.

Deltoid and gluteal intramuscular injections at the same doses are bioequivalent and, therefore, interchangeable.

Distribution

Once absorbed, risperidone is rapidly distributed. The volume of distribution is 1-2 L/kg. In plasma, risperidone is bound to albumin and α 1-acid glycoprotein. The plasma protein binding of risperidone is approximately 90%, and that of its major metabolite, 9-hydroxyrisperidone, is 77%. Neither risperidone nor 9-hydroxyrisperidone displaces each other from plasma binding sites. High therapeutic concentrations of sulfamethazine (100 mcg/mL), warfarin (10 mcg/mL), and carbamazepine (10 mcg/mL) caused only a slight increase in the free fraction of risperidone at 10 ng/mL and of 9-hydroxyrisperidone at 50 ng/mL, changes of unknown clinical significance.

Metabolism and Drug Interactions

Risperidone is extensively metabolized in the liver. The main metabolic pathway is through hydroxylation of risperidone to 9-hydroxyrisperidone by the enzyme, CYP 2D6. A minor metabolic pathway is through N-dealkylation. The main metabolite, 9-hydroxyrisperidone, has similar pharmacological activity as risperidone. Consequently, the clinical effect of the drug results from the combined concentrations of risperidone plus 9-hydroxyrisperidone.

CYP 2D6, also called debrisoquin hydroxylase, is the enzyme responsible for metabolism of many neuroleptics, antidepressants, antiarrhythmics, and other drugs. CYP 2D6 is subject to genetic polymorphism (about 6%-8% of Caucasians, and a very low percentage of Asians, have little or no activity and are "poor metabolizers") and to inhibition by a variety of substrates and some non-substrates, notably quinidine. Extensive CYP 2D6 metabolizers convert risperidone rapidly into 9-hydroxyrisperidone, whereas poor CYP 2D6 metabolizers convert it much more slowly. Although extensive metabolizers have lower risperidone and higher 9-hydroxyrisperidone concentrations than poor metabolizers, the pharmacokinetics of

risperidone and 9-hydroxyrisperidone combined, after single and multiple doses, are similar in extensive and poor metabolizers.

The interactions of RISPERDAL CONSTA[®] with coadministration of other drugs have not been systematically evaluated in human subjects. Drug interactions are based primarily on experience with oral RISPERDAL[®]. Risperidone could be subject to two kinds of drug-drug interactions. First, inhibitors of CYP 2D6 interfere with conversion of risperidone to 9-hydroxyrisperidone [*see Drug Interactions (7.11)*]. This occurs with quinidine, giving essentially all recipients a risperidone pharmacokinetic profile typical of poor metabolizers. The therapeutic benefits and adverse effects of RISPERDAL[®] in patients receiving quinidine have not been evaluated, but observations in a modest number (n \cong 70) of poor metabolizers given oral RISPERDAL[®] do not suggest important differences between poor and extensive metabolizers. Second, coadministration of carbamazepine and other known enzyme inducers (e.g., phenytoin, rifampin, and phenobarbital) with oral RISPERDAL[®] cause a decrease in the combined plasma concentrations of risperidone and 9-hydroxyrisperidone [*see Drug Interactions (7.12)*]. It would also be possible for risperidone to interfere with metabolism of other drugs metabolized by CYP 2D6. Relatively weak binding of risperidone to the enzyme suggests this is unlikely [*see Drug Interactions (7.11)*].

Excretion

Risperidone and its metabolites are eliminated via the urine and, to a much lesser extent, via the feces. As illustrated by a mass balance study of a single 1 mg oral dose of ¹⁴C-risperidone administered as solution to three healthy male volunteers, total recovery of radioactivity at 1 week was 84%, including 70% in the urine and 14% in the feces.

The apparent half-life of risperidone plus 9-hydroxyrisperidone following RISPERDAL CONSTA[®] administration is 3 to 6 days, and is associated with a monoexponential decline in plasma concentrations. This half-life of 3-6 days is related to the erosion of the microspheres and subsequent absorption of risperidone. The clearance of risperidone and risperidone plus 9-hydroxyrisperidone was 13.7 L/h and 5.0 L/h in extensive CYP 2D6 metabolizers, and 3.3 L/h and 3.2 L/h in poor CYP 2D6 metabolizers, respectively. No accumulation of risperidone was observed during long-term use (up to 12 months) in patients treated every 2 weeks with 25 mg or 50 mg RISPERDAL CONSTA[®]. The elimination phase is complete approximately 7 to 8 weeks after the last injection.

Renal Impairment

In patients with moderate to severe renal disease treated with oral RISPERDAL[®], clearance of the sum of risperidone and its active metabolite decreased by 60% compared with young healthy subjects. Although patients with renal impairment were not studied with RISPERDAL

CONSTA[®], it is recommended that patients with renal impairment be carefully titrated on oral RISPERDAL[®] before treatment with RISPERDAL CONSTA[®] is initiated at a dose of 25 mg. A lower initial dose of 12.5 mg may be appropriate when clinical factors warrant dose adjustment, such as in patients with renal impairment [*see Dosage and Administration (2.4)*].

Hepatic Impairment

While the pharmacokinetics of oral RISPERDAL[®] in subjects with liver disease were comparable to those in young healthy subjects, the mean free fraction of risperidone in plasma was increased by about 35% because of the diminished concentration of both albumin and α 1-acid glycoprotein. Although patients with hepatic impairment were not studied with RISPERDAL CONSTA[®], it is recommended that patients with hepatic impairment be carefully titrated on oral RISPERDAL[®] before treatment with RISPERDAL CONSTA[®] is initiated at a dose of 25 mg. A lower initial dose of 12.5 mg may be appropriate when clinical factors warrant dose adjustment, such as in patients with hepatic impairment [*see Dosage and Administration (2.4)*].

Elderly

In an open-label trial, steady-state concentrations of risperidone plus 9-hydroxyrisperidone in otherwise healthy elderly patients (≥ 65 years old) treated with RISPERDAL CONSTA[®] for up to 12 months fell within the range of values observed in otherwise healthy nonelderly patients. Dosing recommendations are the same for otherwise healthy elderly patients and nonelderly patients [*see Dosage and Administration (2)*].

Race and Gender Effects

No specific pharmacokinetic study was conducted to investigate race and gender effects, but a population pharmacokinetic analysis did not identify important differences in the disposition of risperidone due to gender (whether or not corrected for body weight) or race.

13 NONCLINICAL TOXICOLOGY

13.1 Carcinogenesis, Mutagenesis, Impairment of Fertility

Carcinogenesis - Oral

Carcinogenicity studies were conducted in Swiss albino mice and Wistar rats. Risperidone was administered in the diet at doses of 0.63, 2.5, and 10 mg/kg for 18 months to mice and for 25 months to rats. These doses are equivalent to 2.4, 9.4, and 37.5 times the oral maximum recommended human dose (MRHD) for schizophrenia (16 mg/day) on a mg/kg basis, or 0.2, 0.75, and 3 times the oral MRHD (mice) or 0.4, 1.5, and 6 times the oral MRHD (rats) on a mg/m² basis. A maximum tolerated dose was not achieved in male mice. There was a significant increase in pituitary gland adenomas in female mice at doses 0.75 and 3 times the oral MRHD on a mg/m² basis. There was a significant increase in endocrine pancreatic adenomas in male rats at

doses 1.5 and 6 times the oral MRHD on a mg/m² basis. Mammary gland adenocarcinomas were significantly increased in female mice at all doses tested (0.2, 0.75, and 3 times the oral MRHD on a mg/m² basis), in female rats at all doses tested (0.4, 1.5, and 6 times the oral MRHD on a mg/m² basis), and in male rats at a dose 6 times the oral MRHD on a mg/m² basis.

Carcinogenesis - Intramuscular

RISPERDAL CONSTA[®] was evaluated in a 24-month carcinogenicity study in which SPF Wistar rats were treated every 2 weeks with intramuscular (IM) injections of either 5 mg/kg or 40 mg/kg of risperidone. These doses are 1 and 8 times the MRHD (50 mg) on a mg/m² basis. A control group received injections of 0.9% NaCl, and a vehicle control group was injected with placebo microspheres. There was a significant increase in pituitary gland adenomas, endocrine pancreas adenomas, and adrenomedullary pheochromocytomas at 8 times the IM MRHD on a mg/m² basis. The incidence of mammary gland adenocarcinomas was significantly increased in female rats at both doses (1 and 8 times the IM MRHD on a mg/m² basis). A significant increase in renal tubular tumors (adenoma, adenocarcinomas) was observed in male rats at 8 times the IM MRHD on a mg/m² basis. Plasma exposures (AUC) in rats were 0.3 and 2 times (at 5 and 40 mg/kg, respectively) the expected plasma exposure (AUC) at the IM MRHD.

Dopamine D₂ receptor antagonists have been shown to chronically elevate prolactin levels in rodents. Serum prolactin levels were not measured during the carcinogenicity studies of oral risperidone; however, measurements taken during subchronic toxicity studies showed that oral risperidone elevated serum prolactin levels 5- to 6-fold in mice and rats at the same doses used in the oral carcinogenicity studies. Serum prolactin levels increased in a dose-dependent manner up to 6- and 1.5-fold in male and female rats, respectively, at the end of the 24-month treatment with RISPERDAL CONSTA[®] every 2 weeks. Increases in the incidence of pituitary gland, endocrine pancreas, and mammary gland neoplasms have been found in rodents after chronic administration of other antipsychotic drugs and may be prolactin-mediated.

The relevance for human risk of the findings of prolactin-mediated endocrine tumors in rodents is unknown [see *Warnings and Precautions (5.6)*].

Mutagenesis

No evidence of mutagenic potential for oral risperidone was found in the *in vitro* Ames reverse mutation test, *in vitro* mouse lymphoma assay, *in vitro* rat hepatocyte DNA-repair assay, *in vivo* oral micronucleus test in mice, the sex-linked recessive lethal test in *Drosophila*, or the *in vitro* chromosomal aberration test in human lymphocytes or in Chinese hamster cells.

In addition, no evidence of mutagenic potential was found in the *in vitro* Ames reverse mutation test for RISPERDAL CONSTA[®].

Impairment of Fertility

Oral risperidone (0.16 to 5 mg/kg) was shown to impair mating, but not fertility, in Wistar rats in three reproductive studies (two mating and fertility studies and a multigenerational study) at doses 0.1 to 3 times the oral maximum recommended human dose (MRHD) (16 mg/day) on a mg/m² basis. The effect appeared to be in females, since impaired mating behavior was not noted in the mating and fertility study in which males only were treated. In a subchronic study in Beagle dogs in which oral risperidone was administered at doses of 0.31 to 5 mg/kg, sperm motility and concentration were decreased at doses 0.6 to 10 times the oral MRHD on a mg/m² basis. Dose-related decreases were also noted in serum testosterone at the same doses. Serum testosterone and sperm values partially recovered, but remained decreased after treatment was discontinued. No no-effect doses were noted in either rat or dog.

No mating and fertility studies were conducted with RISPERDAL CONSTA[®].

14 CLINICAL STUDIES

14.1 Schizophrenia

The effectiveness of RISPERDAL CONSTA[®] in the treatment of schizophrenia was established, in part, on the basis of extrapolation from the established effectiveness of the oral formulation of risperidone. In addition, the effectiveness of RISPERDAL CONSTA[®] in the treatment of schizophrenia was established in a 12-week, placebo-controlled trial in adult psychotic inpatients and outpatients who met the DSM-IV criteria for schizophrenia.

Efficacy data were obtained from 400 patients with schizophrenia who were randomized to receive injections of 25 mg, 50 mg, or 75 mg RISPERDAL CONSTA[®] or placebo every 2 weeks. During a 1-week run-in period, patients were discontinued from other antipsychotics and were titrated to a dose of 4 mg oral RISPERDAL[®]. Patients who received RISPERDAL CONSTA[®] were given doses of oral RISPERDAL[®] (2 mg for patients in the 25-mg group, 4 mg for patients in the 50-mg group, and 6 mg for patients in the 75-mg group) for the 3 weeks after the first injection to provide therapeutic plasma concentrations until the main release phase of risperidone from the injection site had begun. Patients who received placebo injections were given placebo tablets.

Efficacy was evaluated using the Positive and Negative Syndrome Scale (PANSS), a validated, multi-item inventory, composed of five subscales to evaluate positive symptoms, negative symptoms, disorganized thoughts, uncontrolled hostility/excitement, and anxiety/depression.

The primary efficacy variable in this trial was change from baseline to endpoint in the total PANSS score. The mean total PANSS score at baseline for schizophrenic patients in this study was 81.5.

Total PANSS scores showed significant improvement in the change from baseline to endpoint in schizophrenic patients treated with each dose of RISPERDAL CONSTA[®] (25 mg, 50 mg, or 75 mg) compared with patients treated with placebo. While there were no statistically significant differences between the treatment effects for the three dose groups, the effect size for the 75 mg dose group was actually numerically less than that observed for the 50 mg dose group.

Subgroup analyses did not indicate any differences in treatment outcome as a function of age, race, or gender.

14.2 Bipolar Disorder - Monotherapy

The effectiveness of RISPERDAL CONSTA[®] for the maintenance treatment of Bipolar I Disorder was established in a multicenter, double-blind, placebo-controlled study of adult patients who met DSM-IV criteria for Bipolar Disorder Type I, who were stable on medications or experiencing an acute manic or mixed episode.

A total of 501 patients were treated during a 26-week open-label period with RISPERDAL CONSTA[®] (starting dose of 25 mg, and titrated, if deemed clinically desirable, to 37.5 mg or 50 mg; in patients not tolerating the 25 mg dose, the dose could be reduced to 12.5 mg). In the open-label phase, 303 (60%) patients were judged to be stable and were randomized to double-blind treatment with either the same dose of RISPERDAL CONSTA[®] or placebo and monitored for relapse. The primary endpoint was time to relapse to any mood episode (depression, mania, hypomania, or mixed).

Time to relapse was delayed in patients receiving RISPERDAL CONSTA[®] monotherapy as compared to placebo. The majority of relapses were due to manic rather than depressive symptoms. Based on their bipolar disorder history, subjects entering this study had had, on average, more manic episodes than depressive episodes.

14.3 Bipolar Disorder - Adjunctive Therapy

The effectiveness of RISPERDAL CONSTA[®] as an adjunct to treatment with lithium or valproate for the maintenance treatment of Bipolar Disorder was established in a multi-center, randomized, double-blind, placebo-controlled study of adult patients who met DSM-IV criteria for Bipolar Disorder Type I and who experienced at least 4 episodes of mood disorder requiring psychiatric/clinical intervention in the previous 12 months, including at least 2 episodes in the 6 months prior to the start of the study.

A total of 240 patients were treated during a 16-week open-label period with RISPERDAL CONSTA[®] (starting dose of 25 mg, and titrated, if deemed clinically desirable, to 37.5 mg or 50 mg), as adjunctive therapy in addition to continuing their treatment as usual for their bipolar

disorder, which consisted of mood stabilizers (primarily lithium and valproate), antidepressants, and/or anxiolytics. All oral antipsychotics were discontinued after the first three weeks of the initial RISPERDAL CONSTA[®] injection. In the open-label phase, 124 (51.7%) were judged to be stable for at least the last 4 weeks and were randomized to double-blind treatment with either the same dose of RISPERDAL CONSTA[®] or placebo in addition to continuing their treatment as usual and monitored for relapse during a 52-week period. The primary endpoint was time to relapse to any new mood episode (depression, mania, hypomania, or mixed).

Time to relapse was delayed in patients receiving adjunctive therapy with RISPERDAL CONSTA[®] as compared to placebo. The relapse types were about half depressive and half manic or mixed episodes.

16 HOW SUPPLIED/STORAGE AND HANDLING

RISPERDAL CONSTA[®] (risperidone) is available in dosage strengths of 12.5 mg, 25 mg, 37.5 mg, or 50 mg risperidone. It is provided as a dose pack, consisting of a vial containing the risperidone microspheres, a pre-filled syringe containing 2 mL of diluent for RISPERDAL CONSTA[®], a West-Medimop Vial Adapter[®], and two Terumo SurGuard[®] 3 Needles for intramuscular injection (a 21 G UTW 1-inch needle with needle protection device for deltoid administration and a 20 G TW 2-inch needle with needle protection device for gluteal administration).

12.5-mg vial/kit (NDC 50458-309-11): 41 mg (equivalent to 12.5 mg of risperidone) of a white to off-white powder provided in a vial with a violet flip-off cap (NDC 50458-309-01).

25-mg vial/kit (NDC 50458-306-11): 78 mg (equivalent to 25 mg of risperidone) of a white to off-white powder provided in a vial with a pink flip-off cap (NDC 50458-306-01).

37.5-mg vial/kit (NDC 50458-307-11): 116 mg (equivalent to 37.5 mg of risperidone) of a white to off-white powder provided in a vial with a green flip-off cap (NDC 50458-307-01).

50-mg vial/kit (NDC 50458-308-11): 152 mg (equivalent to 50 mg of risperidone) of a white to off-white powder provided in a vial with a blue flip-off cap (NDC 50458-308-01).

Storage and Handling

The entire dose pack should be stored in the refrigerator (36°-46°F; 2°-8°C) and protected from light.

If refrigeration is unavailable, RISPERDAL CONSTA[®] can be stored at temperatures not exceeding 77°F (25°C) for no more than 7 days prior to administration. Do not expose unrefrigerated product to temperatures above 77°F (25°C).

Keep out of reach of children.

17 PATIENT COUNSELING INFORMATION

Physicians are advised to discuss the following issues with patients for whom they prescribe RISPERDAL CONSTA[®].

17.1 Orthostatic Hypotension

Patients should be advised of the risk of orthostatic hypotension and instructed in nonpharmacologic interventions that help to reduce the occurrence of orthostatic hypotension (e.g., sitting on the edge of the bed for several minutes before attempting to stand in the morning and slowly rising from a seated position) [*see Warnings and Precautions (5.7)*].

17.2 Interference with Cognitive and Motor Performance

Because RISPERDAL CONSTA[®] has the potential to impair judgment, thinking, or motor skills, patients should be cautioned about operating hazardous machinery, including automobiles, until they are reasonably certain that treatment with RISPERDAL CONSTA[®] does not affect them adversely [*see Warnings and Precautions (5.9)*].

17.3 Pregnancy

Patients should be advised to notify their physician if they become pregnant or intend to become pregnant during therapy and for at least 12 weeks after the last injection of RISPERDAL CONSTA[®] [*see Use in Specific Populations (8.1)*].

17.4 Nursing

Patients should be advised not to breast-feed an infant during treatment and for at least 12 weeks after the last injection of RISPERDAL CONSTA[®] [*see Use in Specific Populations (8.3)*].

17.5 Concomitant Medication

Patients should be advised to inform their physicians if they are taking, or plan to take, any prescription or over-the-counter drugs, since there is a potential for interactions [*see Drug Interactions (7)*].

17.6 Alcohol

Patients should be advised to avoid alcohol during treatment with RISPERDAL CONSTA[®] [*see Drug Interactions (7.1)*].

Product of Ireland

Risperidone active ingredient is manufactured by:

Janssen Pharmaceutical

Wallingstown, Little Island, County Cork, Ireland

Microspheres are manufactured by:

Alkermes, Inc.

Wilmington, Ohio

Diluent is manufactured by:

Vetter Pharma Fertigung GmbH & Co. KG

Langenargen, Germany

or

Cilag AG

Schaffhausen, Switzerland

RISPERDAL CONSTA[®] is manufactured for:

Janssen Pharmaceuticals, Inc.

Titusville, NJ 08560

© Janssen Pharmaceuticals, Inc. 2007

**CENTER FOR DRUG EVALUATION AND
RESEARCH**

APPLICATION NUMBER:

021346Orig1s054

PRODUCT QUALITY REVIEW(S)

**Office of Lifecycle Drug Products
Division of Post-Marketing Activities I
Review of Chemistry, Manufacturing, and Controls**

1. NDA Supplement Number: NDA 20272/S075 (Group Lead)

2. Submission(s) Being Reviewed:

Submission	Type	Submission Date	CDER Stamp Date	Assigned Date	PDUFA Goal Date	Review Date
Original Supplement	PA	7/20/16	7/20/16	8/16/16	11/20/16	11/17/16

3. Provides For: Changes in the risperidone drug substance specification and methods by reference to Drug Master File (DMF) 11438

4. Review #: 4

5. Clinical Review Division: Division of Psychiatry Products

6. Name and Address of Applicant:

Janssen Research & Development, LLC
1400 Welsh Road
Spring House, PA 19477

Donna Herdzik, Manager, CMC Global Regulatory Affairs
Phone (b) (6)
FAX: 609-730-2706
Email: dhertzi@its.jnj.com

7. Drug Product:

NDA	Supplement #	Drug Product	Receipt Date
20272	S-075	Risperdal® (risperidone) Film Coated Tablets	7/20/16
20588	S-064	Risperdal® (risperidone) Oral Solution	7/20/16
21444	S-050	Risperdal® (risperidone) Orally Disintegrating Tablets	7/20/16
21346	S-054	Risperdal® Consta (risperidone) Long-Acting Injection	7/20/16

**OFFICE OF LIFE CYCLE PRODUCTS
DIVISION OF POST MARKETING ACTIVITIES I**

Review of Chemistry, Manufacturing, and Controls

Clinical Review Division: Psychiatry Products (HFD-120)

NDA#: 20-272 **REVIEW#:** 3 **REVIEW DATE:** 06/17/2016
20-588
21-444
21-346

<u>SUBMISSION TYPE</u>	<u>DOCUMENT DATE</u>	<u>CDER DATE</u>	<u>ASSIGNED</u>
S-075 (PA)	02/18/2016	02/18/2016	02/24/2016
S-064 (PA)			
S-050 (PA)			
S-054 (PA)			

<u>AMENDMENT</u>	<u>PDUFA GOAL</u>
N/A	06/18/2016

NAME & ADDRESS OF APPLICANT: Janssen Research & Development, LLC
1400 Welsh Road
Spring House, PA 19477

Donna Herdzyk, Manager, CMC Global Regulatory
Affairs
Phone: (b) (6)
FAX: 609-730-2706
Email: dhertzi@its.jnj.com

DRUG PRODUCT NAME

Proprietary: Risperdal[®]/ Risperdal[®] Oral Solution/ Risperdal M-Tab[®]/Risperdal Consta
Long-Acting

Nonproprietary/USAN: Risperidone, USP

Code Name#:

Chem. Type:

Ther. Class:

PHARMACOLOGICAL CATEGORY/INDICATION: Schizophrenia

DOSAGE FORM: Immediate Release Tablet/ Oral Solution/ Orally Disintegrating Tablet.

STRENGTH: 0.25 mg, 0.5mg, 1.0 mg, 2.0 mg, 3.0 mg and 4.0 mg/ 1 mg/mL/ 0.5 mg,
1.0 mg, 2.0 mg, 3.0 mg, and 4.0 mg

ROUTE OF ADMINISTRATION:

Oral

DISPENSED:

Rx

OTC

SPECIAL PRODUCTS:

Yes

No

CHEMICAL NAME, STRUCTURAL FORMULA, MOLECULAR FORMULA,

MOL. WT:

Chemical Name: 3-[2-[4-(6-fluoro-1,2-benzisoxazol-3-yl)-1-piperidinyl]ethyl]-6,7,8,9-tetrahydro-2-methyl-4H-pyridol[1,2-a]pyrimidin-4-one
Molecular Formula: C₂₃H₂₇FN₄O₂
Molecular Weight: 410.485
CAS Number: [106266-06-2]

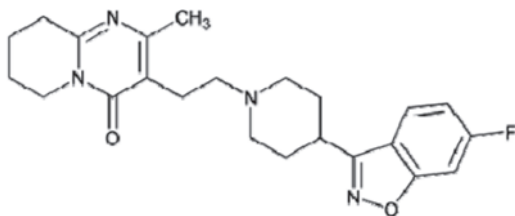

REMARKS/COMMENTS:

The bundled prior approval supplements provide for changes in the risperidone drug substance specification and methods, which are covered by DMF 11438.

In the first review cycle, DMF 11438 was reviewed by Zedong Dong (dated 02/16/2015) and found inadequate. The deficiencies were communicated to the DMF holder. In the resubmission dated 09/30/2015, the applicant states that a DMF amendment has been submitted to address these deficiencies on 09/22/2015. However, DARRTS indicates that this amendment has not been received (also see the update entered by Jayani Perera in Panorama on 01/29/2016). In this review cycle, a DMF review was completed and deficiencies remains (see review in DARRTS by Anjali Bain dated 06/07/2016). The DMF deficiencies have been communicated to the holder on 06/16/2016.

A Complete Response action is recommended for the bundled supplements from CMC standpoint.

CONSULT REVIEW: N/A

COMMENTS/REQUESTS TO BE CONVEYED TO APPLICANT:

DMF 11438 remains deficient. The supplements cannot be approved before the DMF deficiencies are fully resolved. The DMF holder needs to submit the information to address the deficiencies.

CONCLUSIONS & RECOMMENDATIONS:

A Complete Response action is recommended for the bundled supplements due to the deficiencies identified in the review of DMF 11438. The above comment needs to be communicated to the applicant.

(see attached electronic signature page)

Zedong Dong, Ph.D.
Review Chemist

cc: Orig. NDAs#20272/20588/21444/21346
HFD-120/Division File
OLDP/DPMA I/HPatel
OLDP/DPMA I/ZDong

**Zedong
Dong -S**
Digitally signed by Zedong Dong -
S
DN: c=US, o=U.S. Government,
ou=HHS, ou=FDA, ou=People,
cn=Zedong Dong -S,
0.9.2342.19200300.100.1.1=20003
41856
Date: 2016.06.17 13:01:58 -04'00'

**Hasmukh B.
Patel -S**
Digitally signed by Hasmukh B. Patel -S
DN: c=US, o=U.S. Government,
ou=HHS, ou=FDA, ou=People,
0.9.2342.19200300.100.1.1=130006825
4, cn=Hasmukh B. Patel -S
Date: 2016.06.17 15:58:55 -04'00'

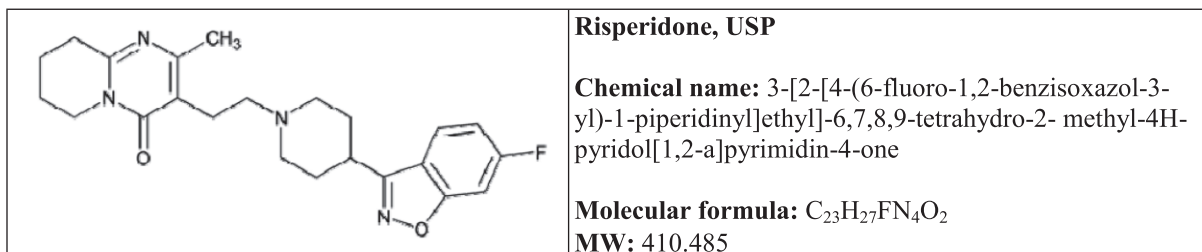
8. Chemical Name and Structure of Drug Substance:**9. Indication:** Schizophrenia**10. Supporting/Relating Documents:** DMF 11438**11. Consults:**

Consults	Recommendation	Date	Reviewer
API Life-Cycle Review Team	Adequate with IR	1/17/16	Anjali Chowdhury Bai

12. Executive Summary:

The grouped prior approval supplements provide for changes in the risperidone drug substance specification and methods, which are covered by DMF 11438. Since the referenced DMF 11438 was inadequate, the supplements have been recommended for Complete Response actions (by Zedong Dong, Ph.D.) in previous three review cycles, with the latest CR letter dated 6/17/16. The latest review of the DMF 11438 recommended the DMF as adequate to support NDA 20-272 (see table, above).

Since the amended DMF was found adequate to support this supplement by the API life-cycle review team on 11/17/2016, the group supplements are recommended for approval.

13. Conclusions & Recommendations:

This supplement is recommended for approval.

14. Comments/Deficiencies to be Conveyed to Applicant:**15. Primary Reviewer:**

Lin Qi, Ph.D., CMC reviewer, Branch 2, Division of Post-Marketing Activities I, Office of Lifecycle Drug Products, Office of Pharmaceutical Quality (OPQ)

16. Secondary Reviewer:

David Lewis, Ph.D., Acting Branch Chief, Branch 2, Division of Post-Marketing Activities I, Office of Lifecycle Drug Products, OPQ

APPEARS THIS WAY ON
ORIGINAL



David
Lewis

Digitally signed by David Lewis

Date: 11/17/2016 03:52:04PM

GUID: 508da7200029f287fa31e664741b577

Comments: concur; this grouped supplement is recommended for approval from the standpoint of CMC due to the recommendation that DMF 11438 is now adequate to support the NDA.



Lin
Qi

Digitally signed by Lin Qi

Date: 11/17/2016 03:50:58PM

GUID: 508da7200029f8811bc57ddc6dd073c

**OFFICE OF LIFE CYCLE PRODUCTS
DIVISION OF POST MARKETING ACTIVITIES I**

Review of Chemistry, Manufacturing, and Controls

Clinical Review Division: Psychiatry Products (HFD-120)

NDA#: 20-272 **REVIEW#:** 2 **REVIEW DATE:** 01/29/2016
20-588
21-444
21-346

<u>SUBMISSION TYPE</u>	<u>DOCUMENT DATE</u>	<u>CDER DATE</u>	<u>ASSIGNED</u>
S-075 (PA)	09/30/2015	09/30/2015	10/14/2015
S-064 (PA)			
S-050 (PA)			
S-054 (PA)			

<u>AMENDMENT</u>	<u>PDUFA GOAL</u>
N/A	01/30/2016

NAME & ADDRESS OF APPLICANT: Janssen Research & Development, LLC
1400 Welsh Road
Spring House, PA 19477

Donna Herdzik, Manager, CMC Global Regulatory
Affairs

Phone [REDACTED] (b) (6)

FAX: 609-730-2706

Email: dhertzi@its.jnj.com

DRUG PRODUCT NAME

Proprietary: Risperdal[®]/ Risperdal[®] Oral Solution/ Risperdal M-Tab[®]/Risperdal Consta
Long-Acting

Nonproprietary/USAN: Risperidone, USP

Code Name#:

Chem. Type:

Ther. Class:

PHARMACOLOGICAL CATEGORY/INDICATION: Schizophrenia

DOSAGE FORM: Immediate Release Tablet/ Oral Solution/ Orally Disintegrating Tablet.

STRENGTH: 0.25 mg, 0.5mg, 1.0 mg, 2.0 mg, 3.0 mg and 4.0 mg/ 1 mg/mL/ 0.5 mg,
1.0 mg, 2.0 mg, 3.0 mg, and 4.0 mg

ROUTE OF ADMINISTRATION: Oral
DISPENSED: Rx OTC
SPECIAL PRODUCTS: Yes No
CHEMICAL NAME, STRUCTURAL FORMULA, MOLECULAR FORMULA,
MOL. WT:

Chemical Name: 3-[2-[4-(6-fluoro-1,2-benzisoxazol-3-yl)-1-piperidinyl]ethyl]-6,7,8,9-tetrahydro-2-methyl-4H-pyridol[1,2-a]pyrimidin-4-one
Molecular Formula: C₂₃H₂₇FN₄O₂
Molecular Weight: 410.485
CAS Number: [106266-06-2]

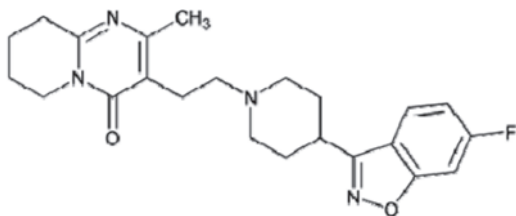

REMARKS/COMMENTS:

The bundled prior approval supplements provide for changes in the risperidone drug substance specification and methods, which are covered by DMF 11438.

In the previous review cycle, DMF 11438 was reviewed by Zedong Dong (dated 02/16/2015) and found inadequate. The deficiencies were communicated to the DMF holder. In the resubmission, the applicant states that a DMF amendment has been submitted to address these deficiencies on 09/22/2015. However, DARRTS indicates that this amendment has not been received (also see the update entered by Jayani Perera in Panorama on 01/29/2016). The DMF holder needs to provide the information to fully resolve the deficiency issues before the supplement can be approved.

A Complete Response action is recommended for the bundled supplements from CMC standpoint.

CONSULT REVIEW: N/A

COMMENTS/REQUESTS TO BE CONVEYED TO APPLICANT:

The supplement cover letter states that a DMF amendment was submitted on 09/22/2015. However, the amendment has not been received by the Agency. The supplement cannot be approved before the DMF deficiencies are fully resolved. The DMF holder needs to submit the information to address the deficiencies.

CONCLUSIONS & RECOMMENDATIONS:

A Complete Response action is recommended for the bundled supplements due to the deficiencies identified in the review of DMF 11438. The above comment needs to be communicated to the applicant.

(see attached electronic signature page)

Zedong Dong, Ph.D.
Review Chemist

cc: Orig. NDAs#20272/20588/21444/21346
HFD-120/Division File
OLDP/DPMA I/HPatel
OLDP/DPMA I/ZDong

**Zedong
Dong -S**
Digitally signed by Zedong
Dong -S
DN: c=US, o=U.S. Government,
ou=HHS, ou=FDA, ou=People,
cn=Zedong Dong -S,
0.9.2342.19200300.100.1.1=200
0341856
Date: 2016.01.29 13:43:28 -05'00'

**David B.
Lewis -S**
Digitally signed by David B.
Lewis -S
DN: c=US, o=U.S.
Government, ou=HHS,
ou=FDA, ou=People,
cn=David B. Lewis -S,
0.9.2342.19200300.100.1.1=1
300124430
Date: 2016.01.29 13:57:15
-05'00'