

CENTER FOR DRUG EVALUATION AND RESEARCH

Approval Package for:

APPLICATION NUMBER:

021346Orig1s063

Trade Name: RISPERDAL CONSTA
Generic or Proper Name: (risperidone)

Sponsor: Janssen Pharmaceuticals Inc.

Approval Date: February 5, 2020

Indication: RISPERDAL® CONSTA® is an atypical antipsychotic indicated:

- for the treatment of schizophrenia.
- as monotherapy or as adjunctive therapy to lithium or valproate for the maintenance treatment of Bipolar I Disorder.

CENTER FOR DRUG EVALUATION AND RESEARCH

021346Orig1s063

CONTENTS

Reviews / Information Included in this NDA Review.

Approval Letter	X
Other Action Letters	
Labeling	X
REMS	
Summary Review	
Officer/Employee List	
Office Director Memo	
Cross Discipline Team Leader Review	
Clinical Review(s)	
Product Quality Review(s)	
Non-Clinical Review(s)	
Statistical Review(s)	
Clinical Microbiology / Virology Review(s)	
Clinical Pharmacology Review(s)	
Other Reviews	X
Risk Assessment and Risk Mitigation Review(s)	
Proprietary Name Review(s)	
Administrative/Correspondence Document(s)	

**CENTER FOR DRUG EVALUATION AND
RESEARCH**

APPLICATION NUMBER:

021346Orig1s063

APPROVAL LETTER



NDA 020272/S-085
NDA 020588/S-072
NDA 021444/S-058
NDA 021346/S-063

SUPPLEMENT APPROVAL

Janssen Research & Development, L.L.C.
Attention: Kelly Rudnick
Director, Global Regulatory Affairs
1400 McKean Road,
Spring House, PA 19477

Dear Ms. Rudnick:

Please refer to your Supplemental New Drug Applications (sNDA) dated and received January 29, 2020, submitted under section 505(b) of the Federal Food, Drug, and Cosmetic Act (FDCA) for Risperdal (risperidone) tablets (NDA 020272), Risperdal (risperidone) oral solution (NDA 020588), Risperdal M-Tab (risperidone) orally disintegrating tablets (NDA 021444), and Risperdal Consta (risperidone) long-acting injection (NDA 021346).

We also refer to our letter dated December 5, 2019, notifying you, under Section 505(o)(4) of the FDCA, of new safety information that we believe should be included in the labeling for risperidone. This information pertains to the risk of Stevens-Johnson syndrome and toxic epidermal necrolysis (SJS/TEN).

These supplemental new drug applications provide for revisions to the labeling for risperidone consistent with our December 5, 2019, letter.

APPROVAL & LABELING

We have completed our review of these applications. They are approved, effective on the date of this letter, for use as recommended in the enclosed agreed-upon labeling.

We note that your January 29, 2020, submission includes final printed labeling (FPL) for your Prescribing Information, Medication Guide. We have not reviewed this FPL. You are responsible for assuring that the wording in this FPL is identical to that of the approved content of labeling in the structured product labeling (SPL) format.

WAIVER OF HIGHLIGHTS SECTION

Please note that we have previously granted a waiver of the requirements of 21 CFR 201.57(d)(8) regarding the length of Highlights of prescribing information.

CONTENT OF LABELING

As soon as possible, but no later than 14 days from the date of this letter, submit the content of labeling [21 CFR 314.50(l)] in structured product labeling (SPL) format using the FDA automated drug registration and listing system (eLIST), as described at FDA.gov.¹ Content of labeling must be identical to the enclosed labeling (text for the Prescribing Information), with the addition of any labeling changes in pending “Changes Being Effected” (CBE) supplements, as well as annual reportable changes not included in the enclosed labeling.

Information on submitting SPL files using eList may be found in the guidance for industry *SPL Standard for Content of Labeling Technical Qs and As*.²

The SPL will be accessible from publicly available labeling repositories.

Also within 14 days, amend all pending supplemental applications that include labeling changes for this NDA, including CBE supplements for which FDA has not yet issued an action letter, with the content of labeling [21 CFR 314.50(l)(1)(i)] in Microsoft Word format, that includes the changes approved in this supplemental application, as well as annual reportable changes. To facilitate review of your submission(s), provide a highlighted or marked-up copy that shows all changes, as well as a clean Microsoft Word version. The marked-up copy should provide appropriate annotations, including supplement number(s) and annual report date(s).

REQUIRED PEDIATRIC ASSESSMENTS

Under the Pediatric Research Equity Act (PREA) (21 U.S.C. 355c), all applications for new active ingredients (which includes new salts and new fixed combinations), new indications, new dosage forms, new dosing regimens, or new routes of administration are required to contain an assessment of the safety and effectiveness of the product for the claimed indication in pediatric patients unless this requirement is waived, deferred, or inapplicable.

Because none of these criteria apply to your application, you are exempt from this requirement.

¹ <http://www.fda.gov/ForIndustry/DataStandards/StructuredProductLabeling/default.htm>

² We update guidances periodically. For the most recent version of a guidance, check the FDA Guidance Documents Database <https://www.fda.gov/RegulatoryInformation/Guidances/default.htm>.

PROMOTIONAL MATERIALS

All promotional materials that include representations about your drug product must be promptly revised to be consistent with the labeling changes approved in this supplement, including any new safety information [21 CFR 314.70(a)(4)]. The revisions in your promotional materials should include prominent disclosure of the important new safety information that appears in the revised labeling. Within 7 days of receipt of this letter, submit your statement of intent to comply with 21 CFR 314.70(a)(4) to the address above, by fax to 301-847-8444, or electronically in eCTD format. For more information about submitting promotional materials in eCTD format, see the draft guidance for industry *Providing Regulatory Submissions in Electronic and Non-Electronic Format-Promotional Labeling and Advertising Materials for Human Prescription Drugs*.

REPORTING REQUIREMENTS

We remind you that you must comply with reporting requirements for an approved NDA (21 CFR 314.80 and 314.81).

If you have any questions, call Ermias Zerislassie, Safety Regulatory Project Manager, at (301) 796-2770.

Sincerely,

{See appended electronic signature page}

Tiffany R. Farchione, MD
Director (Acting)
Division of Psychiatry
Office of Neuroscience
Center for Drug Evaluation and Research

ENCLOSURE:

- Content of Labeling
 - Prescribing Information

This is a representation of an electronic record that was signed electronically. Following this are manifestations of any and all electronic signatures for this electronic record.

/s/

TIFFANY R FARCHIONE
02/05/2020 12:23:40 PM

**CENTER FOR DRUG EVALUATION AND
RESEARCH**

APPLICATION NUMBER:

021346Orig1s063

LABELING

HIGHLIGHTS OF PRESCRIBING INFORMATION

These highlights do not include all the information needed to use RISPERDAL CONSTA® safely and effectively. See full prescribing information for RISPERDAL CONSTA®.

RISPERDAL CONSTA® (risperidone) LONG-ACTING INJECTION

Initial U.S. Approval: 2003

WARNING: INCREASED MORTALITY IN ELDERLY PATIENTS WITH DEMENTIA-RELATED PSYCHOSIS

See full prescribing information for complete boxed warning. Elderly patients with dementia-related psychosis treated with antipsychotic drugs are at an increased risk of death. RISPERDAL CONSTA® is not approved for use in patients with dementia-related psychosis. (5.1)

INDICATIONS AND USAGE

RISPERDAL CONSTA® is an atypical antipsychotic indicated:

- for the treatment of schizophrenia. (1.1)
- as monotherapy or as adjunctive therapy to lithium or valproate for the maintenance treatment of Bipolar I Disorder. (1.2)

DOSAGE AND ADMINISTRATION

- For patients who have never taken oral RISPERDAL®, tolerability should be established with oral RISPERDAL® prior to initiating treatment with RISPERDAL CONSTA®. (2)
- Administer by deep intramuscular (IM) deltoid or gluteal injection. Each injection should be administered by a health care professional using the appropriate enclosed safety needle (1-inch for deltoid administration alternating injections between the two arms and 2-inch for gluteal administration alternating injections between the two buttocks). Do not administer intravenously. (2)
- 25 mg intramuscular (IM) every 2 weeks. Patients not responding to 25 mg may benefit from a higher dose of 37.5 mg or 50 mg. The maximum dose should not exceed 50 mg every 2 weeks. (2)
- Oral RISPERDAL® (or another antipsychotic medication) should be given with the first injection of RISPERDAL CONSTA®, and continued for 3 weeks (and then discontinued) to ensure adequate therapeutic plasma concentrations from RISPERDAL CONSTA®. (2)
- Upward dose adjustment of RISPERDAL CONSTA® should not be made more frequently than every 4 weeks. Clinical effects of each upward dose adjustment should not be anticipated earlier than 3 weeks after injection. (2)
- Avoid inadvertent administration into a blood vessel. (5.16)
- See Full Prescribing Information Section 2.8 for instructions for use.

DOSAGE FORMS AND STRENGTHS

Vial kits: 12.5 mg, 25 mg, 37.5 mg, and 50 mg (3)

CONTRAINDICATIONS

- Known hypersensitivity to risperidone, paliperidone, or to any excipients in RISPERDAL CONSTA®. (4)

WARNINGS AND PRECAUTIONS

- Cerebrovascular events, including stroke, in elderly patients with dementia-related psychosis. RISPERDAL CONSTA® is not approved for use in patients with dementia-related psychosis (5.2)
- Neuroleptic Malignant Syndrome: Manage with immediate discontinuation and close monitoring (5.3)
- Tardive Dyskinesia: Discontinue treatment if clinically appropriate (5.4)
- Metabolic Changes: Atypical antipsychotic drugs have been associated with metabolic changes that may increase cardiovascular/cerebrovascular risk. These metabolic changes include hyperglycemia, dyslipidemia, and weight gain. (5.5)
 - *Hyperglycemia and Diabetes Mellitus:* Monitor patients for symptoms of hyperglycemia including polydipsia, polyuria, polyphagia, and weakness. Monitor glucose regularly in patients with diabetes or at risk for diabetes. (5.5)

○ *Dyslipidemia:* Undesirable alterations have been observed in patients treated with atypical antipsychotics. (5.5)

○ *Weight Gain:* Significant weight gain has been reported. Monitor weight gain. (5.5)

- Hyperprolactinemia: Risperidone treatment may elevate prolactin levels. Long-standing hyperprolactinemia, when associated with hypogonadism, can lead to decreased bone density in men and women. (5.6)
- Orthostatic hypotension: associated with dizziness, tachycardia, bradycardia, and syncope can occur, especially during initial dose titration with oral risperidone. Use caution in patients with cardiovascular disease, cerebrovascular disease, and conditions that could affect hemodynamic responses. (5.7)
- Leukopenia, Neutropenia, and Agranulocytosis have been reported with antipsychotics, including RISPERDAL CONSTA®. Patients with history of a clinically significant low white blood cell count (WBC) or a drug-induced leukopenia/neutropenia should have their complete blood cell count (CBC) monitored frequently during the first few months of therapy and discontinuation of RISPERDAL CONSTA® should be considered at the first sign of a clinically significant decline in WBC in the absence of other causative factors. (5.9)
- Potential for cognitive and motor impairment: has potential to impair judgment, thinking, and motor skills. Use caution when operating machinery, including automobiles. (5.10)
- Seizures: Use cautiously in patients with a history of seizures or with conditions that potentially lower the seizure threshold. (5.11)
- Dysphagia: Esophageal dysmotility and aspiration can occur. Use cautiously in patients at risk for aspiration pneumonia. (5.12)
- Priapism: has been reported. Severe priapism may require surgical intervention. (5.13)
- Thrombotic Thrombocytopenic Purpura (TTP): has been reported. (5.14)
- Avoid inadvertent administration into a blood vessel. (5.16)
- Increased sensitivity in patients with Parkinson's disease or those with dementia with Lewy bodies: has been reported. Manifestations include mental status changes, motor impairment, extrapyramidal symptoms, and features consistent with Neuroleptic Malignant Syndrome. (5.18)
- Diseases or conditions that could affect metabolism or hemodynamic responses: Use with caution in patients with such medical conditions (e.g., recent myocardial infarction or unstable cardiac disease). (5.18)

ADVERSE REACTIONS

The most common adverse reactions in clinical trials in patients with schizophrenia ($\geq 5\%$) were headache, parkinsonism, dizziness, akathisia, fatigue, constipation, dyspepsia, sedation, weight increased, pain in extremity, and dry mouth. The most common adverse reactions in clinical trials in patients with bipolar disorder were weight increased (5% in monotherapy trial) and tremor and parkinsonism ($\geq 10\%$ in adjunctive therapy trial). (6)

The most common adverse reactions that were associated with discontinuation from clinical trials in patients with schizophrenia were agitation, depression, anxiety, and akathisia. Adverse reactions that were associated with discontinuation from bipolar disorder trials were hyperglycemia (one subject monotherapy trial) and hypokinesia and tardive dyskinesia (one subject each in adjunctive therapy trial). (6)

To report SUSPECTED ADVERSE REACTIONS, contact Janssen Pharmaceuticals, Inc. at 1-800-JANSSEN (1-800-526-7736) or FDA at 1-800-FDA-1088 or www.fda.gov/medwatch.

DRUG INTERACTIONS

- Due to CNS effects, use caution when administering with other centrally-acting drugs. Avoid alcohol. (7.1)
- Due to hypotensive effects, hypotensive effects of other drugs with this potential may be enhanced. (7.2)
- Effects of levodopa and dopamine agonists may be antagonized. (7.3)
- Cimetidine and ranitidine increase the bioavailability of risperidone. (7.5)
- Clozapine may decrease clearance of risperidone. (7.6)
- Fluoxetine and paroxetine increase plasma concentrations of risperidone. (7.11)

- Carbamazepine and other enzyme inducers decrease plasma concentrations of risperidone. (7.12)

USE IN SPECIFIC POPULATIONS

- Pregnancy: May cause extrapyramidal and/or withdrawal symptoms in neonates with third trimester exposure. (8.1)
- Renal or Hepatic Impairment: dose appropriately with oral RISPERDAL® prior to initiating treatment with RISPERDAL CONSTA®. A lower starting dose of RISPERDAL CONSTA® of 12.5 mg may be appropriate in some patients. (2.4)

- Pediatric Use: safety and effectiveness not established in patients less than 18 years of age. (8.4)
- Elderly: dosing for otherwise healthy elderly patients is the same as for healthy nonelderly. Elderly may be more predisposed to orthostatic effects than nonelderly. (8.5)

See 17 for PATIENT COUNSELING INFORMATION

Revised: 1/2020

FULL PRESCRIBING INFORMATION: CONTENTS*

WARNING: INCREASED MORTALITY IN ELDERLY PATIENTS WITH DEMENTIA-RELATED PSYCHOSIS

1 INDICATIONS AND USAGE

- 1.1 Schizophrenia
- 1.2 Bipolar Disorder

2 DOSAGE AND ADMINISTRATION

- 2.1 Schizophrenia
- 2.2 Bipolar Disorder
- 2.3 General Dosing Information
- 2.4 Dosage in Special Populations
- 2.5 Reinitiation of Treatment in Patients Previously Discontinued
- 2.6 Switching from Other Antipsychotics
- 2.7 Co-Administration of RISPERDAL CONSTA® with Certain Other Medications
- 2.8 Instructions for Use

3 DOSAGE FORMS AND STRENGTHS

4 CONTRAINDICATIONS

5 WARNINGS AND PRECAUTIONS

- 5.1 Increased Mortality in Elderly Patients with Dementia-Related Psychosis
- 5.2 Cerebrovascular Adverse Events, Including Stroke, in Elderly Patients with Dementia-Related Psychosis
- 5.3 Neuroleptic Malignant Syndrome
- 5.4 Tardive Dyskinesia
- 5.5 Metabolic Changes
- 5.6 Hyperprolactinemia
- 5.7 Orthostatic Hypotension
- 5.8 Falls
- 5.9 Leukopenia, Neutropenia, and Agranulocytosis
- 5.10 Potential for Cognitive and Motor Impairment
- 5.11 Seizures
- 5.12 Dysphagia
- 5.13 Priapism
- 5.14 Thrombotic Thrombocytopenic Purpura (TTP)
- 5.15 Body Temperature Regulation
- 5.16 Administration
- 5.17 Antiemetic Effect
- 5.18 Use in Patients with Concomitant Illness
- 5.19 Osteodystrophy and Tumors in Animals

6 ADVERSE REACTIONS

- 6.1 Commonly-Observed Adverse Reactions in Double-Blind, Placebo-Controlled Clinical Trials - Schizophrenia
- 6.2 Commonly-Observed Adverse Reactions in Double-Blind, Placebo-Controlled Clinical Trials - Bipolar Disorder
- 6.3 Other Adverse Reactions Observed During the Clinical Trial Evaluation of Risperidone
- 6.4 Discontinuations Due to Adverse Reactions

- 6.5 Dose Dependency of Adverse Reactions in Clinical Trials
- 6.6 Changes in ECG
- 6.7 Pain Assessment and Local Injection Site Reactions
- 6.8 Postmarketing Experience

7 DRUG INTERACTIONS

- 7.1 Centrally-Acting Drugs and Alcohol
- 7.2 Drugs with Hypotensive Effects
- 7.3 Levodopa and Dopamine Agonists
- 7.4 Amitriptyline
- 7.5 Cimetidine and Ranitidine
- 7.6 Clozapine
- 7.7 Lithium
- 7.8 Valproate
- 7.9 Digoxin
- 7.10 Topiramate
- 7.11 Drugs That Inhibit CYP 2D6 and Other CYP Isozymes
- 7.12 Carbamazepine and Other CYP 3A4 Enzyme Inducers
- 7.13 Drugs Metabolized by CYP 2D6

8 USE IN SPECIFIC POPULATIONS

- 8.1 Pregnancy
- 8.2 Lactation
- 8.3 Females and Males of Reproductive Potential
- 8.4 Pediatric Use
- 8.5 Geriatric Use

9 DRUG ABUSE AND DEPENDENCE

- 9.1 Controlled Substance
- 9.2 Abuse
- 9.3 Dependence

10 OVERDOSAGE

- 10.1 Human Experience
- 10.2 Management of Overdosage

11 DESCRIPTION

12 CLINICAL PHARMACOLOGY

- 12.1 Mechanism of Action
- 12.2 Pharmacodynamics
- 12.3 Pharmacokinetics

13 NONCLINICAL TOXICOLOGY

- 13.1 Carcinogenesis, Mutagenesis, Impairment of Fertility

14 CLINICAL STUDIES

- 14.1 Schizophrenia
- 14.2 Bipolar Disorder - Monotherapy
- 14.3 Bipolar Disorder - Adjunctive Therapy

16 HOW SUPPLIED/STORAGE AND HANDLING

17 PATIENT COUNSELING INFORMATION

*Sections or subsections omitted from the full prescribing information are not listed.

FULL PRESCRIBING INFORMATION

WARNING: INCREASED MORTALITY IN ELDERLY PATIENTS WITH DEMENTIA-RELATED PSYCHOSIS

Elderly patients with dementia-related psychosis treated with antipsychotic drugs are at an increased risk of death. RISPERDAL CONSTA[®] is not approved for the treatment of patients with dementia-related psychosis. [see *Warnings and Precautions (5.1)*]

1 INDICATIONS AND USAGE

1.1 Schizophrenia

RISPERDAL CONSTA[®] (risperidone) is indicated for the treatment of schizophrenia [see *Clinical Studies (14.1)*].

1.2 Bipolar Disorder

RISPERDAL CONSTA[®] is indicated as monotherapy or as adjunctive therapy to lithium or valproate for the maintenance treatment of Bipolar I Disorder [see *Clinical Studies (14.2, 14.3)*].

2 DOSAGE AND ADMINISTRATION

For patients who have never taken oral RISPERDAL[®], it is recommended to establish tolerability with oral RISPERDAL[®] prior to initiating treatment with RISPERDAL CONSTA[®].

RISPERDAL CONSTA[®] should be administered every 2 weeks by deep intramuscular (IM) deltoid or gluteal injection. Each injection should be administered by a health care professional using the appropriate enclosed safety needle [see *Dosage and Administration (2.8)*]. For deltoid administration, use the 1-inch needle alternating injections between the two arms. For gluteal administration, use the 2-inch needle alternating injections between the two buttocks. Do not administer intravenously.

2.1 Schizophrenia

The recommended dose for the treatment of schizophrenia is 25 mg IM every 2 weeks. Although dose response for effectiveness has not been established for RISPERDAL CONSTA[®], some patients not responding to 25 mg may benefit from a higher dose of 37.5 mg or 50 mg. The maximum dose should not exceed 50 mg RISPERDAL CONSTA[®] every 2 weeks. No additional benefit was observed with dosages greater than 50 mg RISPERDAL CONSTA[®]; however, a higher incidence of adverse effects was observed.

The efficacy of RISPERDAL CONSTA[®] in the treatment of schizophrenia has not been evaluated in controlled clinical trials for longer than 12 weeks. Although controlled studies have not been conducted to answer the question of how long patients with schizophrenia should be treated with RISPERDAL CONSTA[®], oral risperidone has been shown to be effective in delaying time to relapse in longer-term use. It is recommended that responding patients be

continued on treatment with RISPERDAL CONSTA[®] at the lowest dose needed. The physician who elects to use RISPERDAL CONSTA[®] for extended periods should periodically re-evaluate the long-term risks and benefits of the drug for the individual patient.

2.2 Bipolar Disorder

The recommended dose for monotherapy or adjunctive therapy to lithium or valproate for the maintenance treatment of Bipolar I Disorder is 25 mg IM every 2 weeks. Some patients may benefit from a higher dose of 37.5 mg or 50 mg. Dosages above 50 mg have not been studied in this population. The physician who elects to use RISPERDAL CONSTA[®] for extended periods should periodically re-evaluate the long-term risks and benefits of the drug for the individual patient.

2.3 General Dosing Information

A lower initial dose of 12.5 mg may be appropriate when clinical factors warrant dose adjustment, such as in patients with hepatic or renal impairment, for certain drug interactions that increase risperidone plasma concentrations [*see Drug Interactions (7.11)*] or in patients who have a history of poor tolerability to psychotropic medications. The efficacy of the 12.5 mg dose has not been investigated in clinical trials.

Oral RISPERDAL[®] (or another antipsychotic medication) should be given with the first injection of RISPERDAL CONSTA[®] and continued for 3 weeks (and then discontinued) to ensure that adequate therapeutic plasma concentrations are maintained prior to the main release phase of risperidone from the injection site [*see Clinical Pharmacology (12.3)*].

Upward dose adjustment should not be made more frequently than every 4 weeks. The clinical effects of this dose adjustment should not be anticipated earlier than 3 weeks after the first injection with the higher dose.

In patients with clinical factors such as hepatic or renal impairment or certain drug interactions that increase risperidone plasma concentrations [*see Drug Interactions (7.11)*], dose reduction as low as 12.5 mg may be appropriate. The efficacy of the 12.5 mg dose has not been investigated in clinical trials.

Do not combine two different dose strengths of RISPERDAL CONSTA[®] in a single administration.

2.4 Dosage in Special Populations

Elderly

For elderly patients treated with RISPERDAL CONSTA[®], the recommended dosage is 25 mg IM every 2 weeks. Oral RISPERDAL[®] (or another antipsychotic medication) should be given

with the first injection of RISPERDAL CONSTA[®] and should be continued for 3 weeks to ensure that adequate therapeutic plasma concentrations are maintained prior to the main release phase of risperidone from the injection site [*see Clinical Pharmacology (12.3)*].

Renal or Hepatic Impairment

Patients with renal or hepatic impairment should be treated with titrated doses of oral RISPERDAL[®] prior to initiating treatment with RISPERDAL CONSTA[®]. The recommended starting dose is 0.5 mg oral RISPERDAL[®] twice daily during the first week, which can be increased to 1 mg twice daily or 2 mg once daily during the second week. If a total daily dose of at least 2 mg oral RISPERDAL[®] is well tolerated, an injection of 25 mg RISPERDAL CONSTA[®] can be administered every 2 weeks. Oral supplementation should be continued for 3 weeks after the first injection until the main release of risperidone from the injection site has begun. In some patients, slower titration may be medically appropriate. Alternatively, a starting dose of RISPERDAL CONSTA[®] of 12.5 mg may be appropriate. The efficacy of the 12.5 mg dose has not been investigated in clinical trials.

Patients with renal impairment may have less ability to eliminate risperidone than normal adults. Patients with impaired hepatic function may have an increase in the free fraction of the risperidone, possibly resulting in an enhanced effect [*see Clinical Pharmacology (12.3)*]. Elderly patients and patients with a predisposition to hypotensive reactions or for whom such reactions would pose a particular risk should be instructed in nonpharmacologic interventions that help to reduce the occurrence of orthostatic hypotension (e.g., sitting on the edge of the bed for several minutes before attempting to stand in the morning and slowly rising from a seated position). These patients should avoid sodium depletion or dehydration, and circumstances that accentuate hypotension (alcohol intake, high ambient temperature, etc.). Monitoring of orthostatic vital signs should be considered [*see Warnings and Precautions (5.7)*].

2.5 Reinitiation of Treatment in Patients Previously Discontinued

There are no data to specifically address reinitiation of treatment. When restarting patients who have had an interval off treatment with RISPERDAL CONSTA[®], supplementation with oral RISPERDAL[®] (or another antipsychotic medication) should be administered.

2.6 Switching from Other Antipsychotics

There are no systematically collected data to specifically address switching patients from other antipsychotics to RISPERDAL CONSTA[®], or concerning concomitant administration with other antipsychotics. Previous antipsychotics should be continued for 3 weeks after the first injection of RISPERDAL CONSTA[®] to ensure that therapeutic concentrations are maintained until the main release phase of risperidone from the injection site has begun [*see Clinical Pharmacology (12.3)*]. For patients who have never taken oral RISPERDAL[®], it is recommended to establish

tolerability with oral RISPERDAL[®] prior to initiating treatment with RISPERDAL CONSTA[®]. As recommended with other antipsychotic medications, the need for continuing existing EPS medication should be re-evaluated periodically.

2.7 Co-Administration of RISPERDAL CONSTA[®] with Certain Other Medications

Co-administration of carbamazepine and other CYP 3A4 enzyme inducers (e.g., phenytoin, rifampin, phenobarbital) with risperidone would be expected to cause decreases in the plasma concentrations of the sum of risperidone and 9-hydroxyrisperidone combined, which could lead to decreased efficacy of RISPERDAL CONSTA[®] treatment. The dose of risperidone needs to be titrated accordingly for patients receiving these enzyme inducers, especially during initiation or discontinuation of therapy with these inducers [*see Drug Interactions (7.11)*]. At the initiation of therapy with carbamazepine or other known CYP 3A4 hepatic enzyme inducers, patients should be closely monitored during the first 4-8 weeks, since the dose of RISPERDAL CONSTA[®] may need to be adjusted. A dose increase, or additional oral RISPERDAL[®], may need to be considered. On discontinuation of carbamazepine or other CYP 3A4 hepatic enzyme inducers, the dosage of RISPERDAL CONSTA[®] should be re-evaluated and, if necessary, decreased. Patients may be placed on a lower dose of RISPERDAL CONSTA[®] between 2 to 4 weeks before the planned discontinuation of carbamazepine or other CYP 3A4 inducers to adjust for the expected increase in plasma concentrations of risperidone plus 9-hydroxyrisperidone. For patients treated with the recommended dose of 25 mg RISPERDAL CONSTA[®] and discontinuing from carbamazepine or other CYP3A4 enzyme inducers, it is recommended to continue treatment with the 25-mg dose unless clinical judgment necessitates lowering the RISPERDAL CONSTA[®] dose to 12.5 mg or necessitates interruption of RISPERDAL CONSTA[®] treatment. The efficacy of the 12.5 mg dose has not been investigated in clinical trials.

Fluoxetine and paroxetine, CYP 2D6 inhibitors, have been shown to increase the plasma concentration of risperidone 2.5-2.8 fold and 3-9 fold respectively. Fluoxetine did not affect the plasma concentration of 9-hydroxyrisperidone. Paroxetine lowered the concentration of 9-hydroxyrisperidone by about 10%. The dose of risperidone needs to be titrated accordingly when fluoxetine or paroxetine is co-administered. When either concomitant fluoxetine or paroxetine is initiated or discontinued, the physician should re-evaluate the dose of RISPERDAL CONSTA[®]. When initiation of fluoxetine or paroxetine is considered, patients may be placed on a lower dose of RISPERDAL CONSTA[®] between 2 to 4 weeks before the planned start of fluoxetine or paroxetine therapy to adjust for the expected increase in plasma concentrations of risperidone. When fluoxetine or paroxetine is initiated in patients receiving the recommended dose of 25 mg RISPERDAL CONSTA[®], it is recommended to continue treatment with the 25 mg dose unless clinical judgment necessitates lowering the RISPERDAL CONSTA[®] dose to

12.5 mg or necessitates interruption of RISPERDAL CONSTA[®] treatment. When RISPERDAL CONSTA[®] is initiated in patients already receiving fluoxetine or paroxetine, a starting dose of 12.5 mg can be considered. The efficacy of the 12.5 mg dose has not been investigated in clinical trials. The effects of discontinuation of concomitant fluoxetine or paroxetine therapy on the pharmacokinetics of risperidone and 9-hydroxyrisperidone have not been studied. [see *Drug Interactions (7.11)*]

2.8 Instructions for Use

For deltoid or gluteal intramuscular injection only

IMPORTANT RESOURCES

For additional information, visit www.risperdalconsta.com or call Janssen Pharmaceuticals, Inc. at 1-800-JANSSEN (1-800-526-7736).

Important Information

RISPERDAL CONSTA[®] requires close attention to these step-by-step Instructions for Use to help ensure successful administration.

Use components provided

The components in this dose pack are specifically designed for use with RISPERDAL CONSTA[®]. RISPERDAL CONSTA[®] must be reconstituted only in the diluent supplied in the dose pack.

Do not substitute ANY components of the dose pack.

Do not store suspension after reconstitution

Administer dose as soon as possible after reconstitution to avoid settling.

Proper dosing

The entire contents of the vial must be administered to ensure intended dose of RISPERDAL CONSTA[®] is delivered.

SINGLE-USE DEVICE

Do not reuse. Medical devices require specific material characteristics to perform as intended. These characteristics have been verified for single use only. Any attempt to re-process the device for subsequent re-use may adversely affect the integrity of the device or lead to deterioration in performance.

Dose pack contents

Vial Adapter

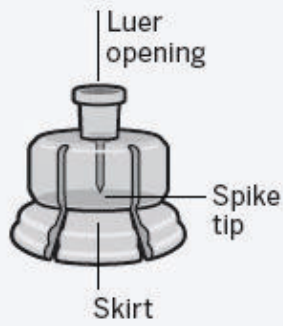

Prefilled Syringe

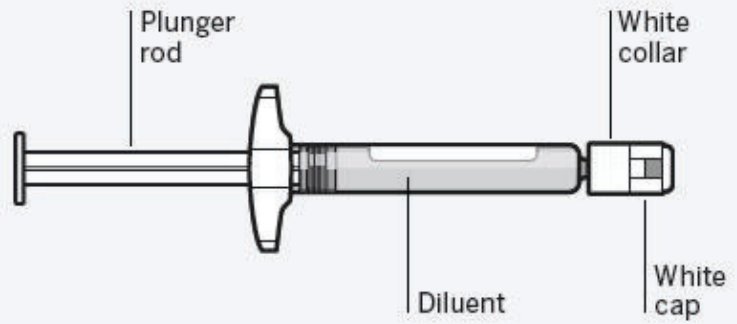

Vial



Terumo SurGuard® 3 Injection Needles

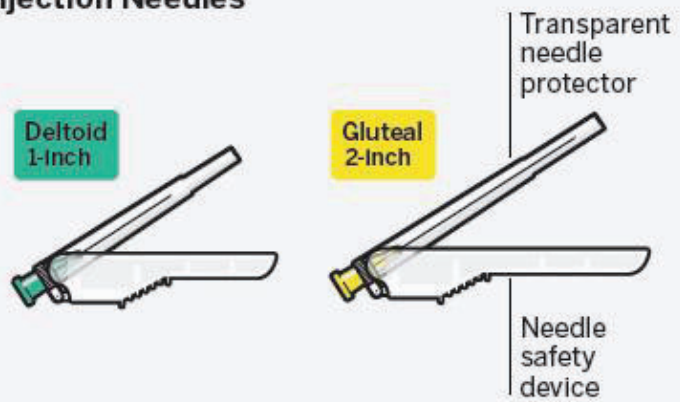

Step 1

Assemble components

Take out dose pack Connect vial adapter to vial



Wait 30 minutes
Remove dose pack from the refrigerator and allow to sit at room temperature for at least **30 minutes** before reconstituting.

Do not warm any other way.



Remove cap from vial
Flip off colored cap from vial.

Wipe top of the grey stopper with an alcohol swab. Allow to air dry.

Do not remove grey rubber stopper.

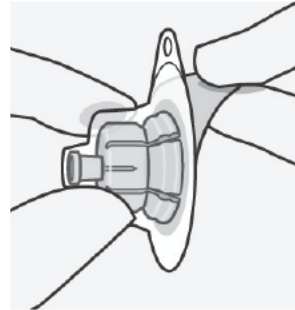

Prepare vial adapter
Hold sterile blister as shown. Peel back and remove paper backing.

Do not remove vial adapter from blister.

Do not touch spike tip at any time. This will result in contamination.



Connect vial adapter to vial

Place vial on a hard surface and hold by the base. Center vial adapter over the grey rubber stopper. Push vial adapter straight down onto vial top until it snaps securely into place.

Do not place vial adapter on at an angle or diluent may leak upon transfer to the vial.



Connect prefilled syringe to vial adapter

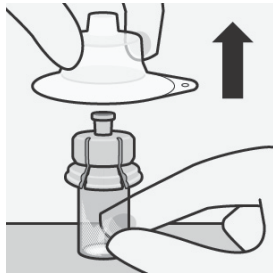

Remove sterile blister

Remove vial adapter from sterile blister only when you are ready to remove the white cap from the prefilled syringe.

Keep vial vertical to prevent leakage. Hold base of vial and pull up on the sterile blister to remove.

Do not shake.

Do not touch exposed luer opening on vial adapter. This will result in contamination.

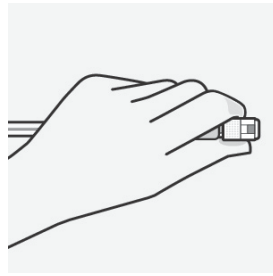

Use proper grip

Hold by white collar at the tip of the syringe.

Do not hold syringe by the glass barrel during assembly.

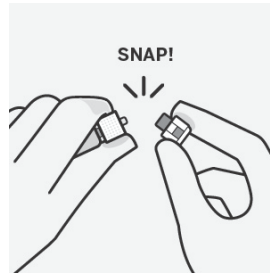
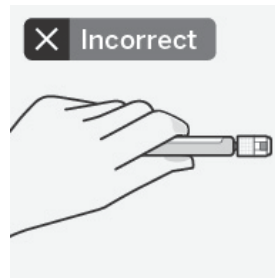

Remove cap

Holding the white collar, snap off the white cap.

Do not twist or cut off the white cap.

Do not touch syringe tip. This will result in contamination.

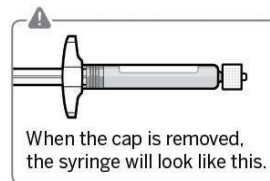

The broken-off cap can be discarded.

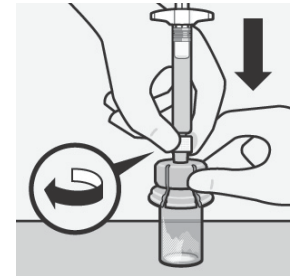

Connect syringe to vial adapter

Hold vial adapter by skirt to keep stationary.

Hold syringe by white collar then insert tip into the luer opening of the vial adapter.

Do not hold the glass syringe barrel. This may cause the white collar to loosen or detach.

Attach the syringe to the vial adapter with a firm **clockwise twisting motion** until it feels snug.

Do not over-tighten. Over-tightening may cause the syringe tip to break.

Step 2

Reconstitute microspheres

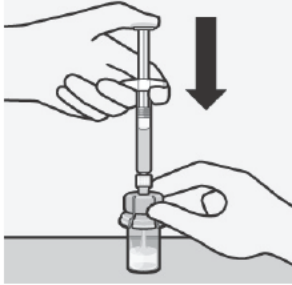

Inject diluent

Inject entire amount of diluent from syringe into the vial.



Vial contents will now be under pressure. **Keep holding the plunger rod down with thumb.**



Suspend microspheres in diluent

Continuing to hold down the plunger rod, **shake vigorously for at least 10 seconds**, as shown.

Check the suspension.

When properly mixed, the suspension appears uniform, thick and milky in color. Microspheres will be visible in the liquid.

Immediately proceed to the next step so suspension does not settle.

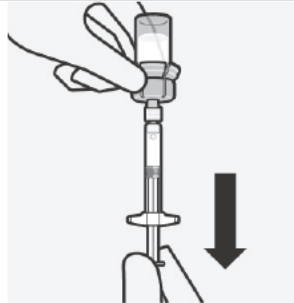

Transfer suspension to syringe

Invert vial completely. Slowly pull plunger rod down to withdraw entire contents from the vial into the syringe.

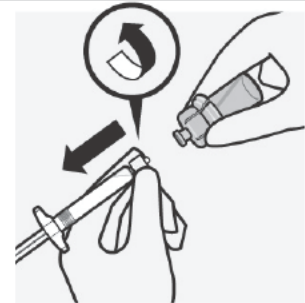

Remove vial adapter

Hold white collar on the syringe and unscrew from vial adapter.

Tear section of the vial label at the perforation. Apply detached label to the syringe for identification purposes.

Discard both vial and vial adapter appropriately.

Step 3

Attach needle

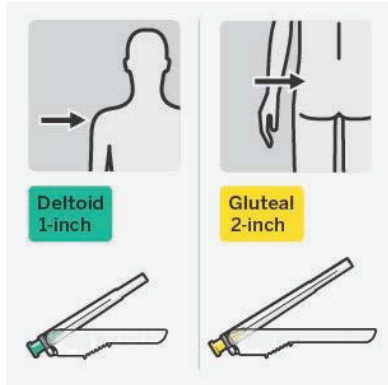

Select appropriate needle

Choose needle based on injection location (gluteal or deltoid).

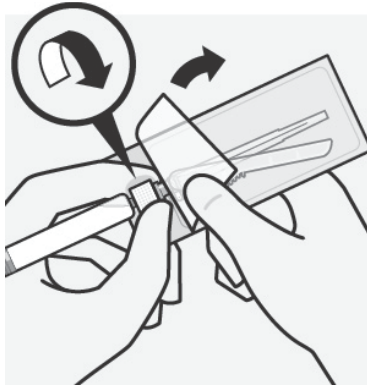

Attach needle

Peel blister pouch open part way and use to grasp the base of the needle, as shown.

Holding the white collar on the syringe, attach syringe to needle luer connection with a firm **clockwise twisting motion** until snug.

Do not touch needle luer opening. This will result in contamination.

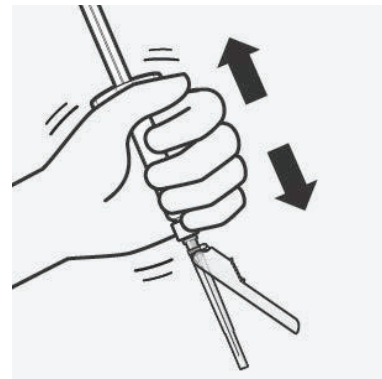

Resuspend microspheres

Fully remove the blister pouch.

Just before injection, shake syringe vigorously again, as some settling will have occurred.

Step 4

Inject dose

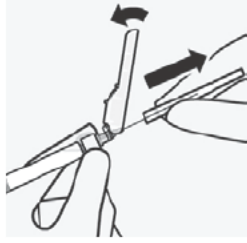

Remove transparent needle protector

Move the needle safety device back towards the syringe, as shown. Then hold white collar on syringe and carefully pull the transparent needle protector straight off.

Do not twist transparent needle protector, as the luer connection may loosen.

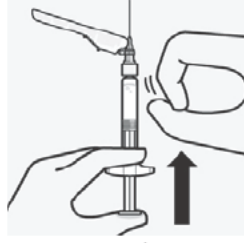

Remove air bubbles

Hold needle upright and tap gently to make any air bubbles rise to the top. Slowly and carefully press plunger rod upward to remove air.

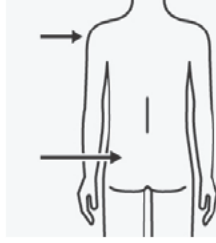

Inject

Immediately inject entire contents of syringe intramuscularly (IM) into the gluteal or deltoid muscle of the patient.

Gluteal injection should be made into the upper-outer quadrant of the gluteal area.

Do not administer intravenously.

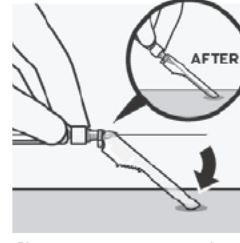

Secure needle in safety device

Using one hand, place needle safety device at a 45-degree angle on a hard, flat surface. Press down with a firm, quick motion until needle is fully engaged in safety device.

Avoid needle stick injury:

Do not use two hands.

Do not intentionally disengage or mishandle the needle safety device.

Do not attempt to straighten the needle or engage the safety device if the needle is bent or damaged.



Properly dispose of needles

Check to confirm needle safety device is fully engaged. Discard in an approved sharps container.

Also discard the unused needle provided in the dose pack.

3 DOSAGE FORMS AND STRENGTHS

RISPERDAL CONSTA[®] is available in dosage strengths of 12.5 mg, 25 mg, 37.5 mg, and 50 mg risperidone. It is provided as a dose pack, consisting of a vial containing the risperidone microspheres, a pre-filled syringe containing 2 mL of diluent for RISPERDAL CONSTA[®], a vial adapter, and two Terumo SurGuard[®] 3 Needles for intramuscular injection (a 21 G UTW 1-inch needle with needle protection device for deltoid administration and a 20 G TW 2-inch needle with needle protection device for gluteal administration).

4 CONTRAINDICATIONS

RISPERDAL CONSTA[®] is contraindicated in patients with a known hypersensitivity to either risperidone or paliperidone, or to any of the excipients in the RISPERDAL CONSTA[®] formulation. Hypersensitivity reactions, including anaphylactic reactions and angioedema, have been reported in patients treated with risperidone and in patients treated with paliperidone. Paliperidone is a metabolite of risperidone.

5 WARNINGS AND PRECAUTIONS

5.1 Increased Mortality in Elderly Patients with Dementia-Related Psychosis

Elderly patients with dementia-related psychosis treated with antipsychotic drugs are at an increased risk of death. Analyses of 17 placebo-controlled trials (modal duration of 10 weeks), largely in patients taking atypical antipsychotic drugs, revealed a risk of death in drug-treated patients of between 1.6 to 1.7 times the risk of death in placebo-treated patients. Over the course of a typical 10-week controlled trial, the rate of death in drug-treated patients was about 4.5%, compared to a rate of about 2.6% in the placebo group. Although the causes of death were varied, most of the deaths appeared to be either cardiovascular (e.g., heart failure, sudden death) or infectious (e.g., pneumonia) in nature. Observational studies suggest that, similar to atypical antipsychotic drugs, treatment with conventional antipsychotic drugs may increase mortality. The extent to which the findings of increased mortality in observational studies may be attributed to the antipsychotic drug as opposed to some characteristic(s) of the patients is not clear.

RISPERDAL CONSTA[®] (risperidone) is not approved for the treatment of dementia-related psychosis [*see Boxed Warning*].

5.2 Cerebrovascular Adverse Events, Including Stroke, in Elderly Patients with Dementia-Related Psychosis

Cerebrovascular adverse events (e.g., stroke, transient ischemic attack), including fatalities, were reported in patients (mean age 85 years; range 73-97) in trials of oral risperidone in elderly patients with dementia-related psychosis. In placebo-controlled trials, there was a significantly higher incidence of cerebrovascular adverse events in patients treated with oral risperidone compared to patients treated with placebo. RISPERDAL CONSTA[®] is not approved for the

treatment of patients with dementia-related psychosis. [See also *Boxed Warning* and *Warnings and Precautions (5.1)*]

5.3 Neuroleptic Malignant Syndrome

A potentially fatal symptom complex sometimes referred to as Neuroleptic Malignant Syndrome (NMS) has been reported in association with antipsychotic drugs. Clinical manifestations of NMS are hyperpyrexia, muscle rigidity, altered mental status, and evidence of autonomic instability (irregular pulse or blood pressure, tachycardia, diaphoresis, and cardiac dysrhythmia). Additional signs may include elevated creatine phosphokinase, myoglobinuria (rhabdomyolysis), and acute renal failure.

The diagnostic evaluation of patients with this syndrome is complicated. In arriving at a diagnosis, it is important to identify cases in which the clinical presentation includes both serious medical illness (e.g., pneumonia, systemic infection, etc.) and untreated or inadequately treated extrapyramidal signs and symptoms (EPS). Other important considerations in the differential diagnosis include central anticholinergic toxicity, heat stroke, drug fever, and primary central nervous system pathology.

The management of NMS should include: (1) immediate discontinuation of antipsychotic drugs and other drugs not essential to concurrent therapy; (2) intensive symptomatic treatment and medical monitoring; and (3) treatment of any concomitant serious medical problems for which specific treatments are available. There is no general agreement about specific pharmacological treatment regimens for uncomplicated NMS.

If a patient requires antipsychotic drug treatment after recovery from NMS, the potential reintroduction of drug therapy should be carefully considered. The patient should be carefully monitored, since recurrences of NMS have been reported.

5.4 Tardive Dyskinesia

A syndrome of potentially irreversible, involuntary, dyskinetic movements may develop in patients treated with antipsychotic drugs. Although the prevalence of the syndrome appears to be highest among the elderly, especially elderly women, it is impossible to rely upon prevalence estimates to predict, at the inception of antipsychotic treatment, which patients are likely to develop the syndrome. Whether antipsychotic drug products differ in their potential to cause tardive dyskinesia is unknown.

The risk of developing tardive dyskinesia and the likelihood that it will become irreversible are believed to increase as the duration of treatment and the total cumulative dose of antipsychotic

drugs administered to the patient increase. However, the syndrome can develop, although much less commonly, after relatively brief treatment periods at low doses.

The syndrome may remit, partially or completely, if antipsychotic treatment is withdrawn. Antipsychotic treatment, itself, however, may suppress (or partially suppress) the signs and symptoms of the syndrome and thereby may possibly mask the underlying process. The effect that symptomatic suppression has upon the long-term course of the syndrome is unknown.

Given these considerations, RISPERDAL CONSTA[®] should be prescribed in a manner that is most likely to minimize the occurrence of tardive dyskinesia. Chronic antipsychotic treatment should generally be reserved for patients who suffer from a chronic illness that: (1) is known to respond to antipsychotic drugs, and (2) for whom alternative, equally effective, but potentially less harmful treatments are not available or appropriate. In patients who do require chronic treatment, the smallest dose and the shortest duration of treatment producing a satisfactory clinical response should be sought. The need for continued treatment should be reassessed periodically.

If signs and symptoms of tardive dyskinesia appear in a patient treated with RISPERDAL CONSTA[®], drug discontinuation should be considered. However, some patients may require treatment with RISPERDAL CONSTA[®] despite the presence of the syndrome.

5.5 Metabolic Changes

Atypical antipsychotic drugs have been associated with metabolic changes that may increase cardiovascular/cerebrovascular risk. These metabolic changes include hyperglycemia, dyslipidemia, and body weight gain. While all of the drugs in the class have been shown to produce some metabolic changes, each drug has its own specific risk profile.

Hyperglycemia and Diabetes Mellitus

Hyperglycemia and diabetes mellitus, in some cases extreme and associated with ketoacidosis or hyperosmolar coma or death, have been reported in patients treated with atypical antipsychotics including RISPERDAL[®]. Assessment of the relationship between atypical antipsychotic use and glucose abnormalities is complicated by the possibility of an increased background risk of diabetes mellitus in patients with schizophrenia and the increasing incidence of diabetes mellitus in the general population. Given these confounders, the relationship between atypical antipsychotic use and hyperglycemia-related adverse events is not completely understood. However, epidemiological studies suggest an increased risk of treatment-emergent hyperglycemia-related adverse events in patients treated with the atypical antipsychotics. Precise risk estimates for hyperglycemia-related adverse events in patients treated with atypical antipsychotics are not available.

Patients with an established diagnosis of diabetes mellitus who are started on atypical antipsychotics, including RISPERDAL[®], should be monitored regularly for worsening of glucose control. Patients with risk factors for diabetes mellitus (e.g., obesity, family history of diabetes) who are starting treatment with atypical antipsychotics, including RISPERDAL[®], should undergo fasting blood glucose testing at the beginning of treatment and periodically during treatment. Any patient treated with atypical antipsychotics, including RISPERDAL[®], should be monitored for symptoms of hyperglycemia including polydipsia, polyuria, polyphagia, and weakness. Patients who develop symptoms of hyperglycemia during treatment with atypical antipsychotics, including RISPERDAL[®], should undergo fasting blood glucose testing. In some cases, hyperglycemia has resolved when the atypical antipsychotic, including RISPERDAL[®], was discontinued; however, some patients required continuation of anti-diabetic treatment despite discontinuation of RISPERDAL[®].

Pooled data from 3 double-blind, placebo-controlled studies in subjects with schizophrenia and 4 double-blind, placebo-controlled monotherapy studies in subjects with bipolar mania with oral risperidone are presented in Table 1.

Table 1. Change in Random Glucose From Seven Placebo-Controlled, 3- to 8-Week, Fixed- or Flexible-Dose Studies in Adult Subjects With Schizophrenia or Bipolar Mania With Oral Risperidone

	Placebo	RISPERDAL [®]	
		1-8 mg/day	>8-16 mg/day
	N=555	N=748	N=164
Serum Glucose	-1.4	0.8	0.6
	Mean change from baseline (mg/dL)		
	Proportion of patients with shifts		
Serum Glucose (<140 mg/dL to ≥200 mg/dL)	0.6% (3/525)	0.4% (3/702)	0% (0/158)

In longer-term, controlled and uncontrolled studies in adult subjects, RISPERDAL[®] was associated with a mean change in glucose of +2.8 mg/dL at Week 24 (N=151) and +4.1 mg/dL at Week 48 (N=50).

Dyslipidemia

Undesirable alterations in lipids have been observed in patients treated with atypical antipsychotics.

Pooled data from 7 placebo-controlled, 3- to 8- week, fixed- or flexible-dose studies in adult subjects with schizophrenia or bipolar mania are presented in Table 2.

Table 2. Change in Random Lipids From Seven Placebo-Controlled, 3- to 8-Week, Fixed- or Flexible-Dose Studies in Adult Subjects With Schizophrenia or Bipolar Mania With Oral Risperidone

	Placebo	RISPERDAL [®]	
		1-8 mg/day	>8-16 mg/day
Mean change from baseline (mg/dL)			
Cholesterol	N=559	N=742	N=156
Change from baseline	0.6	6.9	1.8
Triglycerides	N=183	N=307	N=123
Change from baseline	-17.4	-4.9	-8.3
Proportion of patients With Shifts			
Cholesterol	2.7%	4.3%	6.3%
(<200 mg/dL to ≥240 mg/dL)	(10/368)	(22/516)	(6/96)
Triglycerides	1.1%	2.7%	2.5%
(<500 mg/dL to ≥500 mg/dL)	(2/180)	(8/301)	(3/121)

In longer-term, controlled and uncontrolled studies, RISPERDAL[®] was associated with a mean change in (a) non-fasting cholesterol of +4.4 mg/dL at Week 24 (N=231) and +5.5 mg/dL at Week 48 (N=86); and (b) non-fasting triglycerides of +19.9 mg/dL at Week 24 (N=52).

Weight Gain

Weight gain has been observed with atypical antipsychotic use. Clinical monitoring of weight is recommended.

Data from a placebo-controlled, 12-week, fixed-dose study in adult subjects with schizophrenia are presented in Table 3.

Table 3. Mean Change in Body Weight (kg) and the Proportion of Subjects With ≥7% Gain in Body Weight From a Placebo-Controlled, 12-Week, Fixed-Dose Study in Adult Subjects With Schizophrenia

	Placebo (N=83)	RISPERDAL CONSTA [®]	
		25 mg (N=90)	50 mg (N=87)
Weight (kg)			
Change from baseline	-1.4	0.5	1.2
Weight Gain			
≥7% increase from baseline	6%	10%	8%

In an uncontrolled, longer-term, open-label study, RISPERDAL CONSTA[®] was associated with a mean change in weight of +2.1 kg at Week 24 (N=268) and +2.8 kg at Week 50 (N=199).

5.6 Hyperprolactinemia

As with other drugs that antagonize dopamine D₂ receptors, risperidone elevates prolactin levels and the elevation persists during chronic administration. Risperidone is associated with higher levels of prolactin elevation than other antipsychotic agents.

Hyperprolactinemia may suppress hypothalamic GnRH, resulting in reduced pituitary gonadotropin secretion. This, in turn, may inhibit reproductive function by impairing gonadal steroidogenesis in both female and male patients. Galactorrhea, amenorrhea, gynecomastia, and impotence have been reported in patients receiving prolactin-elevating compounds. Long-standing hyperprolactinemia when associated with hypogonadism may lead to decreased bone density in both female and male subjects.

Tissue culture experiments indicate that approximately one-third of human breast cancers are prolactin dependent *in vitro*, a factor of potential importance if the prescription of these drugs is contemplated in a patient with previously detected breast cancer. An increase in pituitary gland, mammary gland, and pancreatic islet cell neoplasia (mammary adenocarcinomas, pituitary and pancreatic adenomas) was observed in the risperidone carcinogenicity studies conducted in mice and rats [see *Nonclinical Toxicology (13.1)*]. Neither clinical studies nor epidemiologic studies conducted to date have shown an association between chronic administration of this class of drugs and tumorigenesis in humans; the available evidence is considered too limited to be conclusive at this time.

5.7 Orthostatic Hypotension

RISPERDAL CONSTA[®] may induce orthostatic hypotension associated with dizziness, tachycardia, and in some patients, syncope, especially during the initial dose-titration period with oral risperidone, probably reflecting its alpha-adrenergic antagonistic properties. Syncope was reported in 0.8% (12/1499 patients) of patients treated with RISPERDAL CONSTA[®] in multiple-dose studies. Patients should be instructed in nonpharmacologic interventions that help to reduce the occurrence of orthostatic hypotension (e.g., sitting on the edge of the bed for several minutes before attempting to stand in the morning and slowly rising from a seated position).

RISPERDAL CONSTA[®] should be used with particular caution in (1) patients with known cardiovascular disease (history of myocardial infarction or ischemia, heart failure, or conduction abnormalities), cerebrovascular disease, and conditions which would predispose patients to hypotension, e.g., dehydration and hypovolemia, and (2) in the elderly and patients with renal or hepatic impairment. Monitoring of orthostatic vital signs should be considered in all such patients, and a dose reduction should be considered if hypotension occurs. Clinically significant hypotension has been observed with concomitant use of oral RISPERDAL[®] and antihypertensive medication.

5.8 Falls

Somnolence, postural hypotension, motor and sensory instability have been reported with the use of antipsychotics, including RISPERDAL CONSTA[®], which may lead to falls and,

consequently, fractures or other fall-related injuries. For patients, particularly the elderly, with diseases, conditions, or medications that could exacerbate these effects, assess the risk of falls when initiating antipsychotic treatment and recurrently for patients on long-term antipsychotic therapy.

5.9 Leukopenia, Neutropenia, and Agranulocytosis

Class Effect: In clinical trial and/or postmarketing experience, events of leukopenia/neutropenia have been reported temporally related to antipsychotic agents, including RISPERDAL CONSTA[®]. Agranulocytosis has also been reported.

Possible risk factors for leukopenia/neutropenia include pre-existing low white blood cell count (WBC) and a history of drug-induced leukopenia/neutropenia. Patients with a history of a clinically significant low WBC or a drug-induced leukopenia/neutropenia should have their complete blood count (CBC) monitored frequently during the first few months of therapy and discontinuation of RISPERDAL CONSTA[®] should be considered at the first sign of a clinically significant decline in WBC in the absence of other causative factors.

Patients with clinically significant neutropenia should be carefully monitored for fever or other symptoms or signs of infection and treated promptly if such symptoms or signs occur. Patients with severe neutropenia (absolute neutrophil count <1000/mm³) should discontinue RISPERDAL CONSTA[®] and have their WBC followed until recovery.

5.10 Potential for Cognitive and Motor Impairment

Somnolence was reported by 5% of patients treated with RISPERDAL CONSTA[®] in multiple-dose trials. Since risperidone has the potential to impair judgment, thinking, or motor skills, patients should be cautioned about operating hazardous machinery, including automobiles, until they are reasonably certain that treatment with RISPERDAL CONSTA[®] does not affect them adversely.

5.11 Seizures

During premarketing testing, seizures occurred in 0.3% (5/1499 patients) of patients treated with RISPERDAL CONSTA[®]. Therefore, RISPERDAL CONSTA[®] should be used cautiously in patients with a history of seizures.

5.12 Dysphagia

Esophageal dysmotility and aspiration have been associated with antipsychotic drug use. Aspiration pneumonia is a common cause of morbidity and mortality in patients with advanced Alzheimer's dementia. RISPERDAL CONSTA[®] and other antipsychotic drugs should be used

cautiously in patients at risk for aspiration pneumonia. *[see also Boxed Warning and Warnings and Precautions (5.1)]*

5.13 Priapism

Priapism has been reported during postmarketing surveillance *[see Adverse Reactions (6.8)]*. Severe priapism may require surgical intervention.

5.14 Thrombotic Thrombocytopenic Purpura (TTP)

A single case of TTP was reported in a 28 year-old female patient receiving oral RISPERDAL[®] in a large, open premarketing experience (approximately 1300 patients). She experienced jaundice, fever, and bruising, but eventually recovered after receiving plasmapheresis. The relationship to RISPERDAL[®] therapy is unknown.

5.15 Body Temperature Regulation

Disruption of body temperature regulation has been attributed to antipsychotic agents. Both hyperthermia and hypothermia have been reported in association with oral RISPERDAL[®] or RISPERDAL CONSTA[®] use. Caution is advised when prescribing RISPERDAL CONSTA[®] for patients who will be exposed to temperature extremes.

5.16 Administration

RISPERDAL CONSTA[®] should be injected into the deltoid or gluteal muscle, and care must be taken to avoid inadvertent injection into a blood vessel. *[see Dosage and Administration (2) and Adverse Reactions (6.7)]*

5.17 Antiemetic Effect

Risperidone has an antiemetic effect in animals; this effect may also occur in humans, and may mask signs and symptoms of overdose with certain drugs or of conditions such as intestinal obstruction, Reye's syndrome, and brain tumor.

5.18 Use in Patients with Concomitant Illness

Clinical experience with RISPERDAL CONSTA[®] in patients with certain concomitant systemic illnesses is limited. Patients with Parkinson's Disease or Dementia with Lewy Bodies who receive antipsychotics, including RISPERDAL CONSTA[®], are reported to have an increased sensitivity to antipsychotic medications. Manifestations of this increased sensitivity have been reported to include confusion, obtundation, postural instability with frequent falls, extrapyramidal symptoms, and clinical features consistent with the neuroleptic malignant syndrome.

Caution is advisable when using RISPERDAL CONSTA[®] in patients with diseases or conditions that could affect metabolism or hemodynamic responses. RISPERDAL CONSTA[®] has not been evaluated or used to any appreciable extent in patients with a recent history of myocardial infarction or unstable heart disease. Patients with these diagnoses were excluded from clinical studies during the product's premarket testing.

Increased plasma concentrations of risperidone and 9-hydroxyrisperidone occur in patients with severe renal impairment (creatinine clearance <30 mL/min/1.73 m²) treated with oral RISPERDAL[®]; an increase in the free fraction of risperidone is also seen in patients with severe hepatic impairment. Patients with renal or hepatic impairment should be carefully titrated on oral RISPERDAL[®] before treatment with RISPERDAL CONSTA[®] is initiated at a dose of 25 mg. A lower initial dose of 12.5 mg may be appropriate when clinical factors warrant dose adjustment, such as in patients with renal or hepatic impairment [*see Dosage and Administration (2.4)*].

5.19 Osteodystrophy and Tumors in Animals

RISPERDAL CONSTA[®] produced osteodystrophy in male and female rats in a 1-year toxicity study and a 2-year carcinogenicity study at a dose of 40 mg/kg administered IM every 2 weeks.

RISPERDAL CONSTA[®] produced renal tubular tumors (adenoma, adenocarcinoma) and adrenomedullary pheochromocytomas in male rats in the 2-year carcinogenicity study at 40 mg/kg administered IM every 2 weeks. In addition, RISPERDAL CONSTA[®] produced an increase in a marker of cellular proliferation in renal tissue in males in the 1-year toxicity study and in renal tumor-bearing males in the 2-year carcinogenicity study at 40 mg/kg administered IM every 2 weeks. (Cellular proliferation was not measured at the low dose or in females in either study.)

The effect dose for osteodystrophy and the tumor findings is 8 times the IM maximum recommended human dose (MRHD) (50 mg) on a mg/m² basis and is associated with a plasma exposure (AUC) 2 times the expected plasma exposure (AUC) at the IM MRHD. The no-effect dose for these findings was 5 mg/kg (equal to the IM MRHD on a mg/m² basis). Plasma exposure (AUC) at the no-effect dose was one third the expected plasma exposure (AUC) at the IM MRHD.

Neither the renal or adrenal tumors, nor osteodystrophy, were seen in studies of orally administered risperidone. Osteodystrophy was not observed in dogs at doses up to 14 times (based on AUC) the IM MRHD in a 1-year toxicity study.

The renal tubular and adrenomedullary tumors in male rats and other tumor findings are described in more detail in Section 13.1 (Carcinogenicity, Mutagenesis, Impairment of Fertility).

The relevance of these findings to human risk is unknown.

6 ADVERSE REACTIONS

The following are discussed in more detail in other sections of the labeling:

- Increased mortality in elderly patients with dementia-related psychosis [*see Boxed Warning and Warnings and Precautions (5.1)*]
- Cerebrovascular adverse events, including stroke, in elderly patients with dementia-related psychosis [*see Warnings and Precautions (5.2)*]
- Neuroleptic malignant syndrome [*see Warnings and Precautions (5.3)*]
- Tardive dyskinesia [*see Warnings and Precautions (5.4)*]
- Metabolic changes [*see Warnings and Precautions (5.5)*]
- Hyperprolactinemia [*see Warnings and Precautions (5.6)*]
- Orthostatic hypotension [*see Warnings and Precautions (5.7)*]
- Falls [*see Warnings and Precautions (5.8)*]
- Leukopenia/Neutropenia and Agranulocytosis [*see Warnings and Precautions (5.9)*]
- Potential for cognitive and motor impairment [*see Warnings and Precautions (5.10)*]
- Seizures [*see Warnings and Precautions (5.11)*]
- Dysphagia [*see Warnings and Precautions (5.12)*]
- Priapism [*see Warnings and Precautions (5.13)*]
- Thrombotic Thrombocytopenic Purpura (TTP) [*see Warnings and Precautions (5.14)*]
- Disruption of body temperature regulation [*see Warnings and Precautions (5.15)*]
- Avoidance of inadvertent injection into a blood vessel [*see Warnings and Precautions (5.16)*]
- Antiemetic effect [*see Warnings and Precautions (5.17)*]
- Increased sensitivity in patients with Parkinson's disease or those with dementia with Lewy bodies [*see Warnings and Precautions (5.18)*]
- Diseases or conditions that could affect metabolism or hemodynamic responses [*see Warnings and Precautions (5.18)*]
- Osteodystrophy and tumors in animals [*see Warnings and Precautions (5.19)*]

The most common adverse reactions in clinical trials in patients with schizophrenia ($\geq 5\%$) were: headache, parkinsonism, dizziness, akathisia, fatigue, constipation, dyspepsia, sedation, weight increased, pain in extremity, and dry mouth. The most common adverse reactions in the double-blind, placebo-controlled periods of the bipolar disorder trials were weight increased (5% in the monotherapy trial) and tremor and parkinsonism ($\geq 10\%$ in the adjunctive treatment trial).

The most common adverse reactions that were associated with discontinuation from the 12-week double-blind, placebo-controlled trial in patients with schizophrenia (causing discontinuation in $\geq 1\%$ of patients) were agitation, depression, anxiety, and akathisia. Adverse reactions that were associated with discontinuation from the double-blind, placebo-controlled periods of the bipolar disorder trials were hyperglycemia (one patient in the monotherapy trial) and hypokinesia and tardive dyskinesia (one patient each in the adjunctive treatment trial).

The data described in this section are derived from a clinical trial database consisting of 2392 patients exposed to one or more doses of RISPERDAL CONSTA[®] for the treatment of schizophrenia. Of these 2392 patients, 332 were patients who received RISPERDAL CONSTA[®] while participating in a 12-week double-blind, placebo-controlled trial. Two hundred two (202) of the 332 were schizophrenia patients who received 25 mg or 50 mg RISPERDAL CONSTA[®]. The conditions and duration of treatment with RISPERDAL CONSTA[®] in the other clinical trials varied greatly and included (in overlapping categories) double-blind, fixed- and flexible-dose, placebo- or active-controlled studies and open-label phases of studies, inpatients and outpatients, and short-term (up to 12 weeks) and longer-term (up to 4 years) exposures. Safety was assessed by collecting adverse events and performing physical examinations, vital signs, body weights, laboratory analyses, and ECGs.

In addition to the studies in patients with schizophrenia, safety data are presented from a trial assessing the efficacy and safety of RISPERDAL CONSTA[®] when administered as monotherapy for maintenance treatment in patients with bipolar I disorder. The subjects in this multi-center, double-blind, placebo-controlled study were adult patients who met DSM-IV criteria for Bipolar Disorder Type I and who were stable on risperidone (oral or long-acting injection), were stable on other antipsychotics or mood stabilizers, or were experiencing an acute episode. After a 3-week period of treatment with open-label oral risperidone (N=440), subjects who demonstrated an initial response to oral risperidone in this period and those who were stable on risperidone (oral or long-acting injection) at study entry entered into a 26-week stabilization period of open-label RISPERDAL CONSTA[®] (N=501). Subjects who demonstrated a maintained response during this period were then randomized into a 24-month double-blind, placebo-controlled period in which they received RISPERDAL CONSTA[®] (N=154) or placebo (N=149) as monotherapy. Subjects who relapsed or who completed the double-blind period could choose to enter an 8-week open-label RISPERDAL CONSTA[®] extension period (N=160).

Safety data are also presented from a trial assessing the efficacy and safety of RISPERDAL CONSTA[®] when administered as adjunctive maintenance treatment in patients with bipolar disorder. The subjects in this multi-center, double-blind, placebo-controlled study were adult patients who met DSM-IV criteria for Bipolar Disorder Type I or Type II and who experienced at least 4 episodes of mood disorder requiring psychiatric/clinical intervention in the previous 12

months, including at least 2 episodes in the 6 months prior to the start of the study. At the start of this study, all patients (N=275) entered into a 16-week open-label treatment phase in which they received RISPERDAL CONSTA[®] in addition to continuing their treatment as usual, which consisted of various mood stabilizers (primarily lithium and valproate), antidepressants, and/or anxiolytics. Patients who reached remission at the end of this 16-week open-label treatment phase (N=139) were then randomized into a 52-week double-blind, placebo-controlled phase in which they received RISPERDAL CONSTA[®] (N=72) or placebo (n=67) as adjunctive treatment in addition to continuing their treatment as usual. Patients who did not reach remission at the end of the 16-week open-label treatment phase could choose to continue to receive RISPERDAL CONSTA[®] as adjunctive therapy in an open-label manner, in addition to continuing their treatment as usual, for up to an additional 36 weeks as clinically indicated for a total period of up to 52 weeks; these patients (N=70) were also included in the evaluation of safety.

Adverse events during exposure to study treatment were obtained by general inquiry and recorded by clinical investigators using their own terminology. Consequently, to provide a meaningful estimate of the proportion of individuals experiencing adverse events, events were grouped in standardized categories using MedDRA terminology.

Throughout this section, adverse reactions are reported. Adverse reactions are adverse events that were considered to be reasonably associated with the use of RISPERDAL CONSTA[®] (adverse drug reactions) based on the comprehensive assessment of the available adverse event information. A causal association for RISPERDAL CONSTA[®] often cannot be reliably established in individual cases. Further, because clinical trials are conducted under widely varying conditions, adverse reaction rates observed in the clinical trials of a drug cannot be directly compared to rates in the clinical trials of another drug and may not reflect the rates observed in clinical practice.

The majority of all adverse reactions were mild to moderate in severity.

6.1 Commonly-Observed Adverse Reactions in Double-Blind, Placebo-Controlled Clinical Trials - Schizophrenia

Table 4 lists the adverse reactions reported in 2% or more of RISPERDAL CONSTA[®]-treated patients with schizophrenia in one 12-week double-blind, placebo-controlled trial.

Table 4. Adverse Reactions in $\geq 2\%$ of RISPERDAL CONSTA[®]-Treated Patients with Schizophrenia in a 12-Week Double-Blind, Placebo-Controlled Trial

System/Organ Class Adverse Reaction	Percentage of Patients Reporting Event		
	RISPERDAL CONSTA [®] 25 mg (N=99)	50 mg (N=103)	Placebo (N=98)
Eye disorders			
Vision blurred	2	3	0
Gastrointestinal disorders			
Constipation	5	7	1
Dry mouth	0	7	1
Dyspepsia	6	6	0
Nausea	3	4	5
Toothache	1	3	0
Salivary hypersecretion	4	1	0
General disorders and administration site conditions			
Fatigue*	3	9	0
Edema peripheral	2	3	1
Pain	4	1	0
Pyrexia	2	1	0
Infections and infestations			
Upper respiratory tract infection	2	0	1
Investigations			
Weight increased	5	4	2
Weight decreased	4	1	1
Musculoskeletal and connective tissue disorders			
Pain in extremity	6	2	1
Nervous system disorders			
Headache	15	21	12
Parkinsonism*	8	15	9
Dizziness	7	11	6
Akathisia*	4	11	6
Sedation*	5	6	3
Tremor	0	3	0
Syncope	2	1	0
Hypoesthesia	2	0	0
Respiratory, thoracic and mediastinal disorders			
Cough	4	2	3
Sinus congestion	2	0	0
Skin and subcutaneous tissue disorders			
Acne	2	2	0
Dry skin	2	0	0

* Fatigue includes fatigue and asthenia. Parkinsonism includes extrapyramidal disorder, musculoskeletal stiffness, muscle rigidity, and bradykinesia. Akathisia includes akathisia and restlessness. Sedation includes sedation and somnolence.

6.2 Commonly-Observed Adverse Reactions in Double-Blind, Placebo-Controlled Clinical Trials – Bipolar Disorder

Table 5 lists the treatment-emergent adverse reactions reported in 2% or more of RISPERDAL CONSTA[®]-treated patients in the 24-month double-blind, placebo-controlled treatment period of the trial assessing the efficacy and safety of RISPERDAL CONSTA[®] when administered as monotherapy for maintenance treatment in patients with Bipolar I Disorder.

Table 5. Adverse Reactions in $\geq 2\%$ of Patients with Bipolar I Disorder Treated with RISPERDAL CONSTA[®] as Monotherapy in a 24-Month Double-Blind, Placebo-Controlled Trial

System/Organ Class Adverse Reaction	Percentage of Patients Reporting Event	
	RISPERDAL CONSTA [®] (N=154)	Placebo (N=149)
Investigations		
Weight increased	5	1
Nervous system disorders		
Dizziness	3	1
Vascular disorders		
Hypertension	3	1

Table 6 lists the treatment-emergent adverse reactions reported in 4% or more of patients in the 52-week double-blind, placebo-controlled treatment phase of a trial assessing the efficacy and safety of RISPERDAL CONSTA[®] when administered as adjunctive maintenance treatment in patients with bipolar disorder.

Table 6. Adverse Reactions in $\geq 4\%$ of Patients with Bipolar Disorder Treated with RISPERDAL CONSTA[®] as Adjunctive Therapy in a 52-Week Double-Blind, Placebo-Controlled Trial

System/Organ Class Adverse Reaction	Percentage of Patients Reporting Event	
	RISPERDAL CONSTA [®] + Treatment as Usual ^a (N=72)	Placebo + Treatment as Usual ^a (N=67)
General disorders and administration site conditions		
Gait abnormal	4	0
Infections and infestations		
Upper respiratory tract infection	6	3
Investigations		
Weight increased	7	1
Metabolism and nutrition disorders		
Decreased appetite	6	1
Increased appetite	4	0
Musculoskeletal and connective tissue disorders		
Arthralgia	4	3
Nervous system disorders		
Tremor	24	16
Parkinsonism ^b	15	6
Dyskinesia ^b	6	3
Sedation ^c	7	1
Disturbance in attention	4	0
Reproductive system and breast disorders		
Amenorrhea	4	1
Respiratory, thoracic and mediastinal disorders		
Cough	4	1

^a Patients received double-blind RISPERDAL CONSTA[®] or placebo in addition to continuing their treatment as usual, which included mood stabilizers, antidepressants, and/or anxiolytics.

^b Parkinsonism includes muscle rigidity, hypokinesia, cogwheel rigidity, and bradykinesia. Dyskinesia includes muscle twitching and dyskinesia.

^c Sedation includes sedation and somnolence.

6.3 Other Adverse Reactions Observed During the Clinical Trial Evaluation of Risperidone

The following additional adverse reactions occurred in $< 2\%$ of the RISPERDAL CONSTA[®]-treated patients in the above schizophrenia double-blind, placebo-controlled trial dataset, in $< 2\%$ of the RISPERDAL CONSTA[®]-treated patients in the above double-blind, placebo-controlled period of the monotherapy bipolar disorder trial dataset, or in $< 4\%$ of the RISPERDAL CONSTA[®]-treated patients in the above double-blind, placebo-controlled period of the adjunctive treatment bipolar disorder trial dataset. The following also includes additional adverse reactions reported at any frequency in RISPERDAL CONSTA[®]-treated patients who participated in the open-label phases of the above bipolar disorder studies and in other studies, including double-blind, active controlled and open-label studies in schizophrenia and bipolar disorder.

Blood and lymphatic system disorders: anemia, neutropenia

Cardiac disorders: tachycardia, atrioventricular block first degree, palpitations, sinus bradycardia, bundle branch block left, bradycardia, sinus tachycardia, bundle branch block right

Ear and labyrinth disorders: ear pain, vertigo

Endocrine disorders: hyperprolactinemia

Eye disorders: conjunctivitis, visual acuity reduced

Gastrointestinal disorders: diarrhea, vomiting, abdominal pain upper, abdominal pain, stomach discomfort, gastritis

General disorders and administration site conditions: injection site pain, chest discomfort, chest pain, influenza like illness, sluggishness, malaise, induration, injection site induration, injection site swelling, injection site reaction, face edema

Immune system disorders: hypersensitivity

Infections and infestations: nasopharyngitis, influenza, bronchitis, urinary tract infection, rhinitis, respiratory tract infection, ear infection, pneumonia, lower respiratory tract infection, pharyngitis, sinusitis, viral infection, infection, localized infection, cystitis, gastroenteritis, subcutaneous abscess

Injury and poisoning: fall, procedural pain

Investigations: blood prolactin increased, alanine aminotransferase increased, electrocardiogram abnormal, gamma-glutamyl transferase increased, blood glucose increased, hepatic enzyme increased, aspartate aminotransferase increased, electrocardiogram QT prolonged, glucose urine present

Metabolism and nutritional disorders: anorexia, hyperglycemia

Musculoskeletal, connective tissue and bone disorders: posture abnormal, myalgia, back pain, buttock pain, muscular weakness, neck pain, musculoskeletal chest pain

Nervous system disorders: coordination abnormal, dystonia, tardive dyskinesia, drooling, paresthesia, dizziness postural, convulsion, akinesia, hypokinesia, dysarthria

Psychiatric disorders: insomnia, agitation, anxiety, sleep disorder, depression, initial insomnia, libido decreased, nervousness

Renal and urinary disorders: urinary incontinence

Reproductive system and breast disorders: galactorrhea, oligomenorrhea, erectile dysfunction, sexual dysfunction, ejaculation disorder, gynecomastia, breast discomfort, menstruation irregular, menstruation delayed, menstrual disorder, ejaculation delayed

Respiratory, thoracic and mediastinal disorders: nasal congestion, pharyngolaryngeal pain, dyspnea, rhinorrhea

Skin and subcutaneous tissue disorders: rash, eczema, pruritus generalized, pruritus

Vascular disorders: hypotension, orthostatic hypotension

Additional Adverse Reactions Reported with Oral RISPERDAL®

The following is a list of additional adverse reactions that have been reported during the clinical trial evaluation of oral RISPERDAL®, regardless of frequency of occurrence:

Blood and Lymphatic Disorders: granulocytopenia

Cardiac Disorders: atrioventricular block

Ear and Labyrinth Disorders: tinnitus

Eye Disorders: ocular hyperemia, eye discharge, eye rolling, eyelid edema, eye swelling, eyelid margin crusting, dry eye, lacrimation increased, photophobia, glaucoma

Gastrointestinal Disorders: abdominal pain upper, dysphagia, fecaloma, abdominal discomfort, fecal incontinence, lip swelling, cheilitis, apthalism

General Disorders: thirst, feeling abnormal, gait disturbance, pitting edema, edema, chills, discomfort, generalized edema, drug withdrawal syndrome, peripheral coldness

Immune System Disorders: drug hypersensitivity

Infections and Infestations: tonsillitis, eye infection, cellulitis, otitis media, onychomycosis, acarodermatitis, bronchopneumonia, respiratory tract infection, tracheobronchitis, otitis media chronic

Investigations: body temperature increased, heart rate increased, eosinophil count increased, white blood cell count decreased, hemoglobin decreased, blood creatine phosphokinase increased, hematocrit decreased, body temperature decreased, blood pressure decreased, transaminases increased

Metabolism and Nutrition Disorders: polydipsia

Musculoskeletal, Connective Tissue, and Bone Disorders: joint swelling, joint stiffness, rhabdomyolysis, torticollis

Nervous System Disorders: hypertonia, balance disorder, dysarthria, unresponsive to stimuli, depressed level of consciousness, movement disorder, hypokinesia, parkinsonian rest tremor, transient ischemic attack, cerebrovascular accident, masked facies, speech disorder, loss of consciousness, muscle contractions involuntary, akinesia, cerebral ischemia, cerebrovascular disorder, neuroleptic malignant syndrome, diabetic coma, head titubation

Psychiatric Disorders: blunted affect, confusional state, middle insomnia, listlessness, anorgasmia

Renal and Urinary Disorders: enuresis, dysuria, pollakiuria

Reproductive System and Breast Disorders: vaginal discharge, retrograde ejaculation, ejaculation disorder, ejaculation failure, breast enlargement

Respiratory, Thoracic, and Mediastinal Disorders: epistaxis, wheezing, pneumonia aspiration, dysphonia, productive cough, pulmonary congestion, respiratory tract congestion, rales, respiratory disorder, hyperventilation, nasal edema

Skin and Subcutaneous Tissue Disorders: erythema, skin discoloration, skin lesion, skin disorder, rash erythematous, rash papular, hyperkeratosis, dandruff, seborrheic dermatitis, rash generalized, rash maculopapular

Vascular Disorders: flushing

6.4 Discontinuations Due to Adverse Reactions

Schizophrenia

Approximately 11% (22/202) of RISPERDAL CONSTA[®]-treated patients in the 12-week double-blind, placebo-controlled schizophrenia trial discontinued treatment due to an adverse event, compared with 13% (13/98) who received placebo. The adverse reactions associated with discontinuation in two or more RISPERDAL CONSTA[®]-treated patients were: agitation (3%), depression (2%), anxiety (1%), and akathisia (1%).

Bipolar Disorder

In the 24-month double-blind, placebo-controlled treatment period of the trial assessing the efficacy and safety of RISPERDAL CONSTA[®] when administered as monotherapy for maintenance treatment in patients with bipolar I disorder, 1 (0.6%) of 154 RISPERDAL CONSTA[®]-treated patients discontinued due to an adverse reaction (hyperglycemia).

In the 52-week double-blind phase of the placebo-controlled trial in which RISPERDAL CONSTA[®] was administered as adjunctive therapy to patients with bipolar disorder in addition to continuing with their treatment as usual, approximately 4% (3/72) of RISPERDAL CONSTA[®]-treated patients discontinued treatment due to an adverse event, compared with 1.5% (1/67) of placebo-treated patients. Adverse reactions associated with discontinuation in RISPERDAL CONSTA[®]-treated patients were: hypokinesia (one patient) and tardive dyskinesia (one patient).

6.5 Dose Dependency of Adverse Reactions in Clinical Trials

Extrapyramidal Symptoms:

Two methods were used to measure extrapyramidal symptoms (EPS) in the 12-week double-blind, placebo-controlled trial comparing three doses of RISPERDAL CONSTA[®] (25 mg, 50 mg, and 75 mg) with placebo in patients with schizophrenia, including: (1) the incidence of spontaneous reports of EPS symptoms; and (2) the change from baseline to endpoint on the total score (sum of the subscale scores for parkinsonism, dystonia, and dyskinesia) of the Extrapyramidal Symptom Rating Scale (ESRS).

As shown in Table 1, the overall incidence of EPS-related adverse reactions (akathisia, dystonia, parkinsonism, and tremor) in patients treated with 25 mg RISPERDAL CONSTA[®] was comparable to that of patients treated with placebo; the incidence of EPS-related adverse reactions was higher in patients treated with 50 mg RISPERDAL CONSTA[®].

The median change from baseline to endpoint in total ESRS score showed no worsening in patients treated with RISPERDAL CONSTA[®] compared with patients treated with placebo: 0 (placebo group); -1 (25-mg group, significantly less than the placebo group); and 0 (50-mg group).

Dystonia

Class Effect: Symptoms of dystonia, prolonged abnormal contractions of muscle groups, may occur in susceptible individuals during the first few days of treatment. Dystonic symptoms include: spasm of the neck muscles, sometimes progressing to tightness of the throat, swallowing difficulty, difficulty breathing, and/or protrusion of the tongue. While these symptoms can occur at low doses, they occur more frequently and with greater severity with high potency and at higher doses of first generation antipsychotic drugs. An elevated risk of acute dystonia is observed in males and younger age groups.

6.6 Changes in ECG

The electrocardiograms of 202 schizophrenic patients treated with 25 mg or 50 mg RISPERDAL CONSTA[®] and 98 schizophrenic patients treated with placebo in the 12-week double-blind,

placebo-controlled trial were evaluated. Compared with placebo, there were no statistically significant differences in QTc intervals (using Fridericia's and linear correction factors) during treatment with RISPERDAL CONSTA[®].

The electrocardiograms of 227 patients with Bipolar I Disorder were evaluated in the 24-month double-blind, placebo-controlled period. There were no clinically relevant differences in QTc intervals (using Fridericia's and linear correction factors) during treatment with RISPERDAL CONSTA[®] compared to placebo.

The electrocardiograms of 85 patients with bipolar disorder were evaluated in the 52-week double-blind, placebo-controlled trial. There were no statistically significant differences in QTc intervals (using Fridericia's and linear correction factors) during treatment with RISPERDAL CONSTA[®] 25 mg, 37.5 mg, or 50 mg when administered as adjunctive treatment in addition to continuing treatment as usual compared to placebo.

6.7 Pain Assessment and Local Injection Site Reactions

The mean intensity of injection pain reported by patients with schizophrenia using a visual analog scale (0 = no pain to 100 = unbearably painful) decreased in all treatment groups from the first to the last injection (placebo: 16.7 to 12.6; 25 mg: 12.0 to 9.0; 50 mg: 18.2 to 11.8). After the sixth injection (Week 10), investigator ratings indicated that 1% of patients treated with 25 mg or 50 mg RISPERDAL CONSTA[®] experienced redness, swelling, or induration at the injection site.

In a separate study to observe local-site tolerability in which RISPERDAL CONSTA[®] was administered into the deltoid muscle every 2 weeks over a period of 8 weeks, no patient discontinued treatment due to local injection site pain or reaction. Clinician ratings indicated that only mild redness, swelling, or induration at the injection site was observed in subjects treated with 37.5 mg or 50 mg RISPERDAL CONSTA[®] at 2 hours after deltoid injection. All ratings returned to baseline at the predose assessment of the next injection 2 weeks later. No moderate or severe reactions were observed in any subject.

6.8 Postmarketing Experience

The following adverse reactions have been identified during postapproval use of risperidone; because these reactions are reported voluntarily from a population of uncertain size, it is not possible to reliably estimate their frequency: agranulocytosis, alopecia, anaphylactic reaction, angioedema, atrial fibrillation, blood cholesterol increased, blood triglycerides increased, diabetes mellitus, diabetic ketoacidosis in patients with impaired glucose metabolism, drug withdrawal syndrome neonatal, dysgeusia, hypoglycemia, hypothermia, ileus, inappropriate antidiuretic hormone secretion, intestinal obstruction, jaundice, mania, pancreatitis, priapism, QT

prolongation, sleep apnea syndrome, somnambulism, Stevens-Johnson syndrome and toxic epidermal necrolysis (SJS/TEN), thrombocytopenia, urinary retention, and water intoxication. In addition, the following adverse reactions have been observed during postapproval use of RISPERDAL CONSTA[®]: cerebrovascular disorders, including cerebrovascular accidents, and diabetes mellitus aggravated.

Retinal artery occlusion after injection of RISPERDAL CONSTA[®] has been reported during postmarketing surveillance. This has been reported in the presence of abnormal arteriovenous anastomosis.

Serious injection site reactions including abscess, cellulitis, cyst, hematoma, necrosis, nodule, and ulcer have been reported with RISPERDAL CONSTA[®] during postmarketing surveillance. Isolated cases required surgical intervention.

Very rarely, cases of anaphylactic reaction after injection with RISPERDAL CONSTA[®] have been reported during postmarketing experience in patients who have previously tolerated oral risperidone.

7 DRUG INTERACTIONS

The interactions of RISPERDAL CONSTA[®] with coadministration of other drugs have not been systematically evaluated. The drug interaction data provided in this section is based on studies with oral RISPERDAL[®].

7.1 Centrally-Acting Drugs and Alcohol

Given the primary CNS effects of risperidone, caution should be used when RISPERDAL CONSTA[®] is administered in combination with other centrally-acting drugs or alcohol.

7.2 Drugs with Hypotensive Effects

Because of its potential for inducing hypotension, RISPERDAL CONSTA[®] may enhance the hypotensive effects of other therapeutic agents with this potential.

7.3 Levodopa and Dopamine Agonists

RISPERDAL CONSTA[®] may antagonize the effects of levodopa and dopamine agonists.

7.4 Amitriptyline

Amitriptyline did not affect the pharmacokinetics of risperidone or of risperidone and 9-hydroxyrisperidone combined following concomitant administration with oral RISPERDAL[®].

7.5 Cimetidine and Ranitidine

Cimetidine and ranitidine increased the bioavailability of oral risperidone by 64% and 26%, respectively. However, cimetidine did not affect the AUC of risperidone and 9-hydroxyrisperidone combined, whereas ranitidine increased the AUC of risperidone and 9-hydroxyrisperidone combined by 20%.

7.6 Clozapine

Chronic administration of clozapine with risperidone may decrease the clearance of risperidone.

7.7 Lithium

Repeated doses of oral RISPERDAL[®] (3 mg twice daily) did not affect the exposure (AUC) or peak plasma concentrations (C_{max}) of lithium (N=13).

7.8 Valproate

Repeated doses of oral RISPERDAL[®] (4 mg once daily) did not affect the pre-dose or average plasma concentrations and exposure (AUC) of valproate (1000 mg/day in three divided doses) compared to placebo (N=21). However, there was a 20% increase in valproate peak plasma concentration (C_{max}) after concomitant administration of oral RISPERDAL[®].

7.9 Digoxin

Oral RISPERDAL[®] (0.25 mg twice daily) did not show a clinically relevant effect on the pharmacokinetics of digoxin.

7.10 Topiramate

Oral RISPERDAL[®] administered at doses from 1-6 mg/day concomitantly with topiramate 400 mg/day resulted in a 23% decrease in risperidone C_{max} and a 33% decrease in risperidone AUC_{0-12 hour} at steady state. Minimal reductions in the exposure to risperidone and 9-hydroxyrisperidone combined, and no change for 9-hydroxyrisperidone were observed. This interaction is unlikely to be of clinical significance. There was no clinically relevant effect of oral RISPERDAL[®] on the pharmacokinetics of topiramate.

7.11 Drugs That Inhibit CYP 2D6 and Other CYP Isozymes

Risperidone is metabolized to 9-hydroxyrisperidone by CYP 2D6, an enzyme that is polymorphic in the population and that can be inhibited by a variety of psychotropic and other drugs [see *Clinical Pharmacology* (12.3)]. Drug interactions that reduce the metabolism of risperidone to 9-hydroxyrisperidone would increase the plasma concentrations of risperidone and lower the concentrations of 9-hydroxyrisperidone. Analysis of clinical studies involving a modest number of poor metabolizers (n≅70 patients) does not suggest that poor and extensive

metabolizers have different rates of adverse effects. No comparison of effectiveness in the two groups has been made.

In vitro studies showed that drugs metabolized by other CYP isozymes, including 1A1, 1A2, 2C9, 2C19, and 3A4, are only weak inhibitors of risperidone metabolism.

Fluoxetine and Paroxetine

Fluoxetine (20 mg once daily) and paroxetine (20 mg once daily), CYP 2D6 inhibitors, have been shown to increase the plasma concentration of risperidone 2.5-2.8 fold and 3-9 fold respectively. Fluoxetine did not affect the plasma concentration of 9-hydroxyrisperidone. Paroxetine lowered the concentration of 9-hydroxyrisperidone by about 10%. When either concomitant fluoxetine or paroxetine is initiated or discontinued, the physician should re-evaluate the dose of RISPERDAL CONSTA[®]. When initiation of fluoxetine or paroxetine is considered, patients may be placed on a lower dose of RISPERDAL CONSTA[®] between 2 to 4 weeks before the planned start of fluoxetine or paroxetine therapy to adjust for the expected increase in plasma concentrations of risperidone. When fluoxetine or paroxetine is initiated in patients receiving the recommended dose of 25 mg RISPERDAL CONSTA[®], it is recommended to continue treatment with the 25-mg dose unless clinical judgment necessitates lowering the RISPERDAL CONSTA[®] dose to 12.5 mg or necessitates interruption of RISPERDAL CONSTA[®] treatment. When RISPERDAL CONSTA[®] is initiated in patients already receiving fluoxetine or paroxetine, a starting dose of 12.5 mg can be considered. The efficacy of the 12.5 mg dose has not been investigated in clinical trials. [*see also Dosage and Administration (2.5)*]. The effects of discontinuation of concomitant fluoxetine or paroxetine therapy on the pharmacokinetics of risperidone and 9-hydroxyrisperidone have not been studied.

Erythromycin

There were no significant interactions between oral RISPERDAL[®] and erythromycin.

7.12 Carbamazepine and Other CYP 3A4 Enzyme Inducers

Carbamazepine co-administration with oral RISPERDAL[®] decreased the steady-state plasma concentrations of risperidone and 9-hydroxyrisperidone by about 50%. Plasma concentrations of carbamazepine did not appear to be affected. Co-administration of other known CYP 3A4 enzyme inducers (e.g., phenytoin, rifampin, and phenobarbital) with risperidone may cause similar decreases in the combined plasma concentrations of risperidone and 9-hydroxyrisperidone, which could lead to decreased efficacy of RISPERDAL CONSTA[®] treatment. At the initiation of therapy with carbamazepine or other known hepatic enzyme inducers, patients should be closely monitored during the first 4-8 weeks, since the dose of RISPERDAL CONSTA[®] may need to be adjusted. A dose increase, or additional oral RISPERDAL[®], may need to be considered. On discontinuation of carbamazepine or other CYP

3A4 hepatic enzyme inducers, the dosage of RISPERDAL CONSTA[®] should be re-evaluated and, if necessary, decreased. Patients may be placed on a lower dose of RISPERDAL CONSTA[®] between 2 to 4 weeks before the planned discontinuation of carbamazepine or other CYP 3A4 enzyme inducers to adjust for the expected increase in plasma concentrations of risperidone plus 9-hydroxyrisperidone. For patients treated with the recommended dose of 25 mg RISPERDAL CONSTA[®] and discontinuing from carbamazepine or other CYP 3A4 enzyme inducers, it is recommended to continue treatment with the 25-mg dose unless clinical judgment necessitates lowering the RISPERDAL CONSTA[®] dose to 12.5 mg or necessitates interruption of RISPERDAL CONSTA[®] treatment. The efficacy of the 12.5 mg dose has not been investigated in clinical trials. [see also *Dosage and Administration (2.5)*]

7.13 Drugs Metabolized by CYP 2D6

In vitro studies indicate that risperidone is a relatively weak inhibitor of CYP 2D6. Therefore, RISPERDAL CONSTA[®] is not expected to substantially inhibit the clearance of drugs that are metabolized by this enzymatic pathway. In drug interaction studies, oral RISPERDAL[®] did not significantly affect the pharmacokinetics of donepezil and galantamine, which are metabolized by CYP 2D6.

8 USE IN SPECIFIC POPULATIONS

8.1 Pregnancy

Pregnancy Exposure Registry

There is a pregnancy exposure registry that monitors pregnancy outcomes in women exposed to atypical antipsychotics, including RISPERDAL CONSTA[®], during pregnancy. Healthcare providers are encouraged to register patients by contacting the National Pregnancy Registry for Atypical Antipsychotics at 1-866-961-2388 or online at <http://womensmentalhealth.org/clinical-and-research-programs/pregnancyregistry/>.

Risk Summary

Neonates exposed to antipsychotic drugs during the third trimester of pregnancy are at risk for extrapyramidal and/or withdrawal symptoms following delivery (*see Clinical Considerations*). Overall, available data from published epidemiologic studies of pregnant women exposed to risperidone have not established a drug-associated risk of major birth defects, miscarriage, or adverse maternal or fetal outcomes (*see Data*). There are risks to the mother associated with untreated schizophrenia or bipolar I disorder and with exposure to antipsychotics, including RISPERDAL CONSTA[®], during pregnancy (*see Clinical Considerations*). Risperidone has been detected in plasma in adult subjects up to 8 weeks after a single-dose administration of RISPERDAL CONSTA[®] [see *Clinical Pharmacology (12.3)*]. The clinical significance of

RISPERDAL CONSTA[®] administered before pregnancy or anytime during pregnancy is not known.

Oral administration of risperidone to pregnant mice caused cleft palate at doses 3 to 4 times the maximum recommended human dose (MRHD) with maternal toxicity observed at 4-times the MRHD based on mg/m² body surface area. Risperidone was not teratogenic in rats or rabbits at doses up to 6-times the MRHD based on mg/m² body surface area. Increased stillbirths and decreased birth weight occurred after oral risperidone administration to pregnant rats at 1.5-times the MRHD based on mg/m² body surface area. Learning was impaired in offspring of rats when the dams were dosed at 0.6-times the MRHD and offspring mortality increased at doses 0.1 to 3 times the MRHD based on mg/m² body surface area.

The estimated background risk of major birth defects and miscarriage for the indicated population is unknown. All pregnancies have a background risk of birth defect, loss, or other adverse outcomes. In the U.S. general population, the estimated background risk of major birth defects and miscarriage in clinically recognized pregnancies is 2-4% and 15-20%, respectively.

Clinical Considerations

Disease-associated maternal and/or embryo/fetal risk

There is a risk to the mother from untreated schizophrenia or bipolar I disorder, including increased risk of relapse, hospitalization, and suicide. Schizophrenia and bipolar I disorder are associated with increased adverse perinatal outcomes, including preterm birth. It is not known if this is a direct result of the illness or other comorbid factors.

Fetal/Neonatal Adverse Reactions

Extrapyramidal and/or withdrawal symptoms, including agitation, hypertonia, hypotonia, tremor, somnolence, respiratory distress, and feeding disorder have been reported in neonates who were exposed to antipsychotic drugs, including RISPERDAL CONSTA[®], during the third trimester of pregnancy. These symptoms have varied in severity. Monitor neonates for extrapyramidal and/or withdrawal symptoms and manage symptoms appropriately. Some neonates recovered within hours or days without specific treatment; others required prolonged hospitalization.

Data

Human Data

Published data from observational studies, birth registries, and case reports on the use of atypical antipsychotics during pregnancy do not report a clear association with antipsychotics and major birth defects. A prospective observational study including 6 women treated with risperidone demonstrated placental passage of risperidone. A retrospective cohort study from a Medicaid database of 9258 women exposed to antipsychotics during pregnancy did not indicate an overall

increased risk for major birth defects. There was a small increase in the risk major of birth defects (RR=1.26, 95% CI 1.02-1.56) and of cardiac malformations (RR=1.26, 95% CI 0.88-1.81) in a subgroup of 1566 women exposed to risperidone during the first trimester of pregnancy; however, there is no mechanism of action to explain the difference in malformation rates.

Animal Data

Oral administration of risperidone to pregnant mice during organogenesis caused cleft palate at 10 mg/kg/day which is 3 times the MRHD of 16 mg/day based on mg/m^2 body surface area; maternal toxicity occurred at 4 times the MRHD. Risperidone was not teratogenic when administered orally to rats at 0.6 to 10 mg/kg/day and rabbits at 0.3 to 5 mg/kg/day, which are up to 6 times the MRHD of 16 mg/day risperidone based on mg/m^2 body surface area. Learning was impaired in offspring of rats dosed orally throughout pregnancy at 1 mg/kg/day which is 0.6 times the MRHD and neuronal cell death increased in fetal brains of offspring of rats dosed during pregnancy at 1 and 2 mg/kg/day which are 0.6 and 1.2 times the MRHD based on mg/m^2 body surface area; postnatal development and growth of the offspring were also delayed.

Rat offspring mortality increased during the first 4 days of lactation when pregnant rats were dosed throughout gestation at 0.16 to 5 mg/kg/day which are 0.1 to 3 times the MRHD of 16 mg/day based on mg/m^2 body surface area. It is not known whether these deaths were due to a direct effect on the fetuses or pups or to effects on the dams; a no-effect dose could not be determined. The rate of stillbirths was increased at 2.5 mg/kg or 1.5 times the MRHD based on mg/m^2 body surface area.

In a rat cross-fostering study the number of live offspring was decreased, the number of stillbirths increased, and the birth weight was decreased in offspring of drug-treated pregnant rats. In addition, the number of deaths increased by Day 1 among offspring of drug-treated pregnant rats, regardless of whether or not the offspring were cross-fostered. Risperidone also appeared to impair maternal behavior in that offspring body weight gain and survival (from Day 1 to 4 of lactation) were reduced in offspring born to control but reared by drug-treated dams. All of these effects occurred at 5 mg/kg which is 3 times the MRHD based on mg/m^2 and the only dose tested in the study.

8.2 Lactation

Risk Summary

Limited data from published literature reports the presence of risperidone and its metabolite, 9-hydroxyrisperidone, in human breast milk at relative infant dose ranging between 2.3% and 4.7% of the maternal weight-adjusted dosage. There are reports of sedation, failure to thrive, jitteriness, and extrapyramidal symptoms (tremors and abnormal muscle movements) in

breastfed infants exposed to risperidone (*see Clinical Considerations*). Risperidone has been detected in plasma in adult subjects up to 8 weeks after a single-dose administration of RISPERDAL CONSTA® [*see Clinical Pharmacology (12.3)*], and the clinical significance on the breastfed infant is not known. There is no information on the effects of risperidone on milk production. The developmental and health benefits of breastfeeding should be considered along with the mother's clinical need for RISPERDAL CONSTA® and any potential adverse effects on the breastfed child from RISPERDAL CONSTA® or from the mother's underlying condition.

Clinical Considerations

Infants exposed to RISPERDAL CONSTA® through breastmilk should be monitored for excess sedation, failure to thrive, jitteriness, and extrapyramidal symptoms (tremors and abnormal muscle movements).

8.3 Females and Males of Reproductive Potential

Infertility

Females

Based on the pharmacologic action of risperidone (D2 receptor antagonism), treatment with RISPERDAL CONSTA® may result in an increase in serum prolactin levels, which may lead to a reversible reduction in fertility in females of reproductive potential [*see Warnings and Precautions (5.6)*].

8.4 Pediatric Use

Safety and effectiveness of RISPERDAL CONSTA® in pediatric patients have not been established. However, juvenile animal toxicology studies have been conducted with oral risperidone.

Juvenile Animal Studies

Juvenile dogs were treated with oral risperidone from weeks 10 to 50 of age (equivalent to the period of childhood through adolescence in humans), at doses of 0.31, 1.25, or 5 mg/kg/day, which are 1.2, 3.4 and 13.5 times the MRHD of 6 mg/day for children, based on mg/m² body surface area. Bone length and density were decreased with a no-effect dose of 0.31 mg/kg/day; this dose produced plasma AUC of risperidone plus its active metabolite paliperidone (9-hydroxy-risperidone) that were similar to those in children and adolescents receiving the MRHD of 6 mg/day. In addition, sexual maturation was delayed at all doses in both males and females. The above effects showed little or no reversibility in females after a 12 week drug-free recovery period. Juvenile rats, treated with oral risperidone from days 12 to 50 of age (equivalent to the period of infancy through adolescence in humans) showed impaired learning and memory performance (reversible only in females), with a no-effect dose of 0.63 mg/kg/day which is 0.5 times the MRHD of 6 mg/day for children, based on mg/m² body surface area. This dose

produced plasma AUC of risperidone plus paliperidone about half the exposure observed in humans at the MRHD. No other consistent effects on neurobehavioral or reproductive development were seen up to the highest tested dose of 1.25 mg/kg/day which is 1 time the MRHD and produced plasma AUC of risperidone plus paliperidone that were about two thirds of those observed in humans at the MRHD of 6 mg/day for children.

8.5 Geriatric Use

In an open-label study, 57 clinically stable, elderly patients (≥ 65 years old) with schizophrenia or schizoaffective disorder received RISPERDAL CONSTA[®] every 2 weeks for up to 12 months. In general, no differences in the tolerability of RISPERDAL CONSTA[®] were observed between otherwise healthy elderly and nonelderly patients. Therefore, dosing recommendations for otherwise healthy elderly patients are the same as for nonelderly patients. Because elderly patients exhibit a greater tendency to orthostatic hypotension than nonelderly patients, elderly patients should be instructed in nonpharmacologic interventions that help to reduce the occurrence of orthostatic hypotension (e.g., sitting on the edge of the bed for several minutes before attempting to stand in the morning and slowly rising from a seated position). In addition, monitoring of orthostatic vital signs should be considered in elderly patients for whom orthostatic hypotension is of concern [*see Warnings and Precautions (5.7)*].

Concomitant use with Furosemide in Elderly Patients with Dementia-Related Psychosis

In two of four placebo-controlled trials in elderly patients with dementia-related psychosis, a higher incidence of mortality was observed in patients treated with furosemide plus oral risperidone when compared to patients treated with oral risperidone alone or with oral placebo plus furosemide. No pathological mechanism has been identified to explain this finding, and no consistent pattern for cause of death was observed. An increase of mortality in elderly patients with dementia-related psychosis was seen with the use of oral risperidone regardless of concomitant use with furosemide. RISPERDAL CONSTA[®] is not approved for the treatment of patients with dementia-related psychosis. [*see Boxed Warning and Warnings and Precautions (5.1)*]

9 DRUG ABUSE AND DEPENDENCE

9.1 Controlled Substance

RISPERDAL CONSTA[®] (risperidone) is not a controlled substance.

9.2 Abuse

RISPERDAL CONSTA[®] has not been systematically studied in animals or humans for its potential for abuse. Because RISPERDAL CONSTA[®] is to be administered by health care professionals, the potential for misuse or abuse by patients is low.

9.3 Dependence

RISPERDAL CONSTA[®] has not been systematically studied in animals or humans for its potential for tolerance or physical dependence.

10 OVERDOSAGE

10.1 Human Experience

No cases of overdose were reported in premarketing studies with RISPERDAL CONSTA[®]. Because RISPERDAL CONSTA[®] is to be administered by health care professionals, the potential for overdose by patients is low.

In premarketing experience with oral RISPERDAL[®], there were eight reports of acute RISPERDAL[®] overdose, with estimated doses ranging from 20 to 300 mg and no fatalities. In general, reported signs and symptoms were those resulting from an exaggeration of the drug's known pharmacological effects, i.e., drowsiness and sedation, tachycardia and hypotension, and extrapyramidal symptoms. One case, involving an estimated overdose of 240 mg, was associated with hyponatremia, hypokalemia, prolonged QT, and widened QRS. Another case, involving an estimated overdose of 36 mg, was associated with a seizure.

Postmarketing experience with oral RISPERDAL[®] includes reports of acute overdose, with estimated doses of up to 360 mg. In general, the most frequently reported signs and symptoms are those resulting from an exaggeration of the drug's known pharmacological effects, i.e., drowsiness, sedation, tachycardia, hypotension, and extrapyramidal symptoms. Other adverse reactions reported since market introduction related to oral RISPERDAL[®] overdose include prolonged QT interval and convulsions. Torsade de pointes has been reported in association with combined overdose of oral RISPERDAL[®] and paroxetine.

10.2 Management of Overdosage

In case of acute overdosage, establish and maintain an airway and ensure adequate oxygenation and ventilation. Cardiovascular monitoring should commence immediately and should include continuous electrocardiographic monitoring to detect possible arrhythmias. If antiarrhythmic therapy is administered, disopyramide, procainamide, and quinidine carry a theoretical hazard of QT prolonging effects that might be additive to those of risperidone. Similarly, it is reasonable to expect that the alpha-blocking properties of bretylium might be additive to those of risperidone, resulting in problematic hypotension.

There is no specific antidote to risperidone. Therefore, appropriate supportive measures should be instituted. The possibility of multiple drug involvement should be considered. Hypotension and circulatory collapse should be treated with appropriate measures, such as intravenous fluids and/or sympathomimetic agents (epinephrine and dopamine should not be used, since beta

stimulation may worsen hypotension in the setting of risperidone-induced alpha blockade). In cases of severe extrapyramidal symptoms, anticholinergic medication should be administered. Close medical supervision and monitoring should continue until the patient recovers.

11 DESCRIPTION

RISPERDAL CONSTA[®] contains risperidone, an atypical antipsychotic belonging to the chemical class of benzisoxazole derivatives. The chemical designation is 3-[2-[4-(6-fluoro-1,2-benzisoxazol-3-yl)-1-piperidinyl]ethyl]-6,7,8,9-tetrahydro-2-methyl-4H-pyrido[1,2-a]pyrimidin-4-one. Its molecular formula is C₂₃H₂₇FN₄O₂ and its molecular weight is 410.49. The structural formula is:

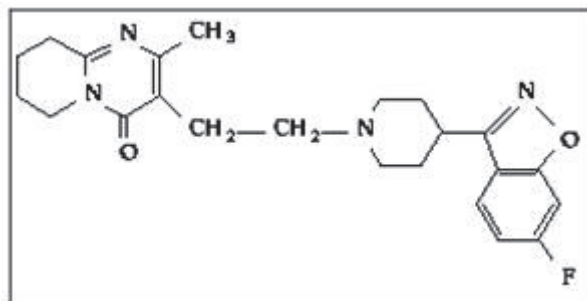

Risperidone is practically insoluble in water, freely soluble in methylene chloride, and soluble in methanol and 0.1 N HCl.

RISPERDAL CONSTA[®] (risperidone) Long-Acting Injection is a combination of extended-release microspheres for injection and diluent for parenteral use.

The extended-release microspheres formulation is a white to off-white, free-flowing powder that is available in dosage strengths of 12.5 mg, 25 mg, 37.5 mg, or 50 mg risperidone per vial. Risperidone is micro-encapsulated in 7525 polylactide-co-glycolide (PLG) at a concentration of 381 mg risperidone per gram of microspheres.

The diluent for parenteral use is a clear, colorless solution. Composition of the diluent includes citric acid anhydrous, disodium hydrogen phosphate dihydrate, polysorbate 20, sodium carboxymethyl cellulose, sodium chloride, sodium hydroxide, and water for injection. The microspheres are suspended in the diluent prior to injection.

RISPERDAL CONSTA[®] is provided as a dose pack, consisting of a vial containing the microspheres, a pre-filled syringe containing the diluent, a vial adapter, and two Terumo SurGuard[®] 3 Needles (a 21 G UTW 1-inch needle with needle protection device for deltoid administration and a 20 G TW 2-inch needle with needle protection device for gluteal administration).

12 CLINICAL PHARMACOLOGY

12.1 Mechanism of Action

The mechanism of action of risperidone in schizophrenia is unclear. The drug's therapeutic activity in schizophrenia could be mediated through a combination of dopamine Type 2 (D₂) and serotonin Type 2 (5HT₂) receptor antagonism. The clinical effect from risperidone results from the combined concentrations of risperidone and its major active metabolite, 9-hydroxyrisperidone (paliperidone) [see *Clinical Pharmacology (12.3)*]. Antagonism at receptors other than D₂ and 5HT₂ may explain some of the other effects of risperidone [see *Clinical Pharmacology (12.1)*].

12.2 Pharmacodynamics

Risperidone is a monoaminergic antagonist with high affinity (K_i of 0.12 to 7.3 nM) for the serotonin Type 2 (5HT₂), dopamine Type 2 (D₂), α₁ and α₂ adrenergic, and H₁ histaminergic receptors. Risperidone showed low to moderate affinity (K_i of 47 to 253 nM) for the serotonin 5HT_{1C}, 5HT_{1D}, and 5HT_{1A} receptors, weak affinity (K_i of 620 to 800 nM) for the dopamine D₁ and haloperidol-sensitive sigma site, and no affinity (when tested at concentrations >10⁻⁵ M) for cholinergic muscarinic or β₁ and β₂ adrenergic receptors.

12.3 Pharmacokinetics

Absorption

After a single intramuscular (gluteal) injection of RISPERDAL CONSTA[®], there is a small initial release of the drug (< 1% of the dose), followed by a lag time of 3 weeks. The main release of the drug starts from 3 weeks onward, is maintained from 4 to 6 weeks, and subsides by 7 weeks following the intramuscular (IM) injection. Therefore, oral antipsychotic supplementation should be given during the first 3 weeks of treatment with RISPERDAL CONSTA[®] to maintain therapeutic levels until the main release of risperidone from the injection site has begun [see *Dosage and Administration (2)*]. Following single doses of RISPERDAL CONSTA[®], the pharmacokinetics of risperidone, 9-hydroxyrisperidone (the major metabolite), and risperidone plus 9-hydroxyrisperidone were linear in the dosing range of 12.5 mg to 50 mg.

The combination of the release profile and the dosage regimen (IM injections every 2 weeks) of RISPERDAL CONSTA[®] results in sustained therapeutic concentrations. Steady-state plasma concentrations are reached after 4 injections and are maintained for 4 to 6 weeks after the last injection. Following multiple doses of 25 mg and 50 mg RISPERDAL CONSTA[®], plasma concentrations of risperidone, 9-hydroxyrisperidone, and risperidone plus 9-hydroxyrisperidone were linear.

Deltoid and gluteal intramuscular injections at the same doses are bioequivalent and, therefore, interchangeable.

Distribution

Once absorbed, risperidone is rapidly distributed. The volume of distribution is 1-2 L/kg. In plasma, risperidone is bound to albumin and α 1-acid glycoprotein. The plasma protein binding of risperidone is approximately 90%, and that of its major metabolite, 9-hydroxyrisperidone, is 77%. Neither risperidone nor 9-hydroxyrisperidone displaces each other from plasma binding sites. High therapeutic concentrations of sulfamethazine (100 mcg/mL), warfarin (10 mcg/mL), and carbamazepine (10 mcg/mL) caused only a slight increase in the free fraction of risperidone at 10 ng/mL and of 9-hydroxyrisperidone at 50 ng/mL, changes of unknown clinical significance.

Metabolism and Drug Interactions

Risperidone is extensively metabolized in the liver. The main metabolic pathway is through hydroxylation of risperidone to 9-hydroxyrisperidone by the enzyme, CYP 2D6. A minor metabolic pathway is through N-dealkylation. The main metabolite, 9-hydroxyrisperidone, has similar pharmacological activity as risperidone. Consequently, the clinical effect of the drug results from the combined concentrations of risperidone plus 9-hydroxyrisperidone.

CYP 2D6, also called debrisoquin hydroxylase, is the enzyme responsible for metabolism of many neuroleptics, antidepressants, antiarrhythmics, and other drugs. CYP 2D6 is subject to genetic polymorphism (about 6%-8% of Caucasians, and a very low percentage of Asians, have little or no activity and are "poor metabolizers") and to inhibition by a variety of substrates and some non-substrates, notably quinidine. Extensive CYP 2D6 metabolizers convert risperidone rapidly into 9-hydroxyrisperidone, whereas poor CYP 2D6 metabolizers convert it much more slowly. Although extensive metabolizers have lower risperidone and higher 9-hydroxyrisperidone concentrations than poor metabolizers, the pharmacokinetics of risperidone and 9-hydroxyrisperidone combined, after single and multiple doses, are similar in extensive and poor metabolizers.

The interactions of RISPERDAL CONSTA[®] with coadministration of other drugs have not been systematically evaluated in human subjects. Drug interactions are based primarily on experience with oral RISPERDAL[®]. Risperidone could be subject to two kinds of drug-drug interactions. First, inhibitors of CYP 2D6 interfere with conversion of risperidone to 9-hydroxyrisperidone [*see Drug Interactions (7.11)*]. This occurs with quinidine, giving essentially all recipients a risperidone pharmacokinetic profile typical of poor metabolizers. The therapeutic benefits and adverse effects of RISPERDAL[®] in patients receiving quinidine have not been evaluated, but observations in a modest number ($n \cong 70$) of poor metabolizers given oral RISPERDAL[®] do not suggest important differences between poor and extensive metabolizers. Second, coadministration of carbamazepine and other known enzyme inducers (e.g., phenytoin, rifampin, and phenobarbital) with oral RISPERDAL[®] cause a decrease in the combined plasma

concentrations of risperidone and 9-hydroxyrisperidone [*see Drug Interactions (7.12)*]. It would also be possible for risperidone to interfere with metabolism of other drugs metabolized by CYP 2D6. Relatively weak binding of risperidone to the enzyme suggests this is unlikely [*see Drug Interactions (7.11)*].

Excretion

Risperidone and its metabolites are eliminated via the urine and, to a much lesser extent, via the feces. As illustrated by a mass balance study of a single 1 mg oral dose of ¹⁴C-risperidone administered as solution to three healthy male volunteers, total recovery of radioactivity at 1 week was 84%, including 70% in the urine and 14% in the feces.

The apparent half-life of risperidone plus 9-hydroxyrisperidone following RISPERDAL CONSTA[®] administration is 3 to 6 days, and is associated with a monoexponential decline in plasma concentrations. This half-life of 3-6 days is related to the erosion of the microspheres and subsequent absorption of risperidone. The clearance of risperidone and risperidone plus 9-hydroxyrisperidone was 13.7 L/h and 5.0 L/h in extensive CYP 2D6 metabolizers, and 3.3 L/h and 3.2 L/h in poor CYP 2D6 metabolizers, respectively. No accumulation of risperidone was observed during long-term use (up to 12 months) in patients treated every 2 weeks with 25 mg or 50 mg RISPERDAL CONSTA[®]. The elimination phase is complete approximately 7 to 8 weeks after the last injection.

Renal Impairment

In patients with moderate to severe renal disease treated with oral RISPERDAL[®], clearance of the sum of risperidone and its active metabolite decreased by 60% compared with young healthy subjects. Although patients with renal impairment were not studied with RISPERDAL CONSTA[®], it is recommended that patients with renal impairment be carefully titrated on oral RISPERDAL[®] before treatment with RISPERDAL CONSTA[®] is initiated at a dose of 25 mg. A lower initial dose of 12.5 mg may be appropriate when clinical factors warrant dose adjustment, such as in patients with renal impairment [*see Dosage and Administration (2.4)*].

Hepatic Impairment

While the pharmacokinetics of oral RISPERDAL[®] in subjects with liver disease were comparable to those in young healthy subjects, the mean free fraction of risperidone in plasma was increased by about 35% because of the diminished concentration of both albumin and α 1-acid glycoprotein. Although patients with hepatic impairment were not studied with RISPERDAL CONSTA[®], it is recommended that patients with hepatic impairment be carefully titrated on oral RISPERDAL[®] before treatment with RISPERDAL CONSTA[®] is initiated at a dose of 25 mg. A lower initial dose of 12.5 mg may be appropriate when clinical factors warrant

dose adjustment, such as in patients with hepatic impairment [see *Dosage and Administration (2.4)*].

Elderly

In an open-label trial, steady-state concentrations of risperidone plus 9-hydroxyrisperidone in otherwise healthy elderly patients (≥ 65 years old) treated with RISPERDAL CONSTA® for up to 12 months fell within the range of values observed in otherwise healthy nonelderly patients. Dosing recommendations are the same for otherwise healthy elderly patients and nonelderly patients [see *Dosage and Administration (2)*].

Race and Gender Effects

No specific pharmacokinetic study was conducted to investigate race and gender effects, but a population pharmacokinetic analysis did not identify important differences in the disposition of risperidone due to gender (whether or not corrected for body weight) or race.

13 NONCLINICAL TOXICOLOGY

13.1 Carcinogenesis, Mutagenesis, Impairment of Fertility

Carcinogenesis - Oral

Risperidone was administered in the diet at doses of 0.63, 2.5, and 10 mg/kg for 18 months to mice and for 25 months to rats. These doses are equivalent to approximately 0.2, 0.75, and 3 times (mice) and 0.4, 1.5, and 6 times (rats) the MRHD of 16 mg/day, based on mg/m² body surface area. A maximum tolerated dose was not achieved in male mice. There was a significant increase in pituitary gland adenomas, endocrine pancreatic adenomas, and mammary gland adenocarcinomas. The table below summarizes the multiples of the human dose on mg/m² (mg/kg) basis at which these tumors occurred.

Tumor Type	Species	Sex	Multiples of Maximum Human Dose in mg/m ² (mg/kg)	
			Lowest Effect Level	Highest No-Effect Level
Pituitary adenomas	mouse	Female	0.75 (9.4)	0.2 (2.4)
Endocrine pancreas adenomas	rat	Male	1.5 (9.4)	0.4 (2.4)
Mammary gland adenocarcinomas	mouse	Female	0.2 (2.4)	none
	rat	Female	0.4 (2.4)	none
	rat	Male	6.0 (37.5)	1.5 (9.4)
Mammary gland neoplasm, Total	rat	Male	1.5 (9.4)	0.4 (2.4)

Antipsychotic drugs have been shown to chronically elevate prolactin levels in rodents. Serum prolactin levels were not measured during the risperidone carcinogenicity studies; however, measurements during subchronic toxicity studies showed that risperidone elevated serum prolactin levels 5-6 fold in mice and rats at the same doses used in the carcinogenicity studies. An increase in mammary, pituitary, and endocrine pancreas neoplasms has been found in rodents

after chronic administration of other antipsychotic drugs and is considered to be prolactin-mediated. The relevance for human risk of the findings of prolactin-mediated endocrine tumors in rodents is unclear [see *Warnings and Precautions (5.6)*].

Carcinogenesis - Intramuscular

Risperidone was evaluated in a 24-month carcinogenicity study in which SPF Wistar rats were treated every 2 weeks with intramuscular (IM) injections of either 5 mg/kg or 40 mg/kg of risperidone. These doses are 1 and 8 times the MRHD (50 mg) on a mg/m² basis. A control group received injections of 0.9% NaCl, and a vehicle control group was injected with placebo microspheres. There was a significant increase in pituitary gland adenomas, endocrine pancreas adenomas, and adrenomedullary pheochromocytomas at 8 times the IM MRHD on a mg/m² basis. The incidence of mammary gland adenocarcinomas was significantly increased in female rats at both doses (1 and 8 times the IM MRHD on a mg/m² basis). A significant increase in renal tubular tumors (adenoma, adenocarcinomas) was observed in male rats at 8 times the IM MRHD on a mg/m² basis. Plasma exposures (AUC) in rats were 0.3 and 2 times (at 5 and 40 mg/kg, respectively) the expected plasma exposure (AUC) at the IM MRHD.

Dopamine D₂ receptor antagonists have been shown to chronically elevate prolactin levels in rodents. Serum prolactin levels were not measured during the carcinogenicity studies of oral risperidone; however, measurements taken during subchronic toxicity studies showed that oral risperidone elevated serum prolactin levels 5- to 6-fold in mice and rats at the same doses used in the oral carcinogenicity studies. Serum prolactin levels increased in a dose-dependent manner up to 6- and 1.5-fold in male and female rats, respectively, at the end of the 24-month treatment with risperidone every 2 weeks IM. Increases in the incidence of pituitary gland, endocrine pancreas, and mammary gland neoplasms have been found in rodents after chronic administration of other antipsychotic drugs and may be prolactin-mediated.

The relevance for human risk of the findings of prolactin-mediated endocrine tumors in rodents is unknown [see *Warnings and Precautions (5.6)*].

Mutagenesis

No evidence of mutagenic or clastogenic potential for risperidone was found in the *in vitro* tests of Ames gene mutation, the mouse lymphoma assay, rat hepatocyte DNA-repair assay, the chromosomal aberration test in human lymphocytes, Chinese hamster ovary cells, or in the *in vivo* micronucleus test in mice, and the sex-linked recessive lethal test in *Drosophila*.

In addition, no evidence of mutagenic potential was found in the *in vitro* Ames reverse mutation test for RISPERDAL CONSTA[®].

Impairment of Fertility

Oral risperidone (0.16 to 5 mg/kg) impaired mating, but not fertility, in rat reproductive studies at doses 0.1 to 3 times the oral maximum recommended human dose (MRHD of 16 mg/day) based on mg/m² body surface area. The effect appeared to be in females, since impaired mating behavior was not noted in the male fertility study. In a subchronic study in Beagle dogs in which oral risperidone was administered at doses of 0.31 to 5 mg/kg, sperm motility and concentration were decreased at doses 0.6 to 10 times the oral MRHD on mg/m² basis. Dose-related decreases were also noted in serum testosterone at the same doses. Serum testosterone and sperm parameters partially recovered, but remained decreased after treatment was discontinued. A no-effect dose could not be determined in either rat or dog.

14 CLINICAL STUDIES

14.1 Schizophrenia

The effectiveness of RISPERDAL CONSTA[®] in the treatment of schizophrenia was established, in part, on the basis of extrapolation from the established effectiveness of the oral formulation of risperidone. In addition, the effectiveness of RISPERDAL CONSTA[®] in the treatment of schizophrenia was established in a 12-week, placebo-controlled trial in adult psychotic inpatients and outpatients who met the DSM-IV criteria for schizophrenia.

Efficacy data were obtained from 400 patients with schizophrenia who were randomized to receive injections of 25 mg, 50 mg, or 75 mg RISPERDAL CONSTA[®] or placebo every 2 weeks. During a 1-week run-in period, patients were discontinued from other antipsychotics and were titrated to a dose of 4 mg oral RISPERDAL[®]. Patients who received RISPERDAL CONSTA[®] were given doses of oral RISPERDAL[®] (2 mg for patients in the 25-mg group, 4 mg for patients in the 50-mg group, and 6 mg for patients in the 75-mg group) for the 3 weeks after the first injection to provide therapeutic plasma concentrations until the main release phase of risperidone from the injection site had begun. Patients who received placebo injections were given placebo tablets.

Efficacy was evaluated using the Positive and Negative Syndrome Scale (PANSS), a validated, multi-item inventory, composed of five subscales to evaluate positive symptoms, negative symptoms, disorganized thoughts, uncontrolled hostility/excitement, and anxiety/depression.

The primary efficacy variable in this trial was change from baseline to endpoint in the total PANSS score. The mean total PANSS score at baseline for schizophrenic patients in this study was 81.5.

Total PANSS scores showed significant improvement in the change from baseline to endpoint in schizophrenic patients treated with each dose of RISPERDAL CONSTA[®] (25 mg, 50 mg, or 75

mg) compared with patients treated with placebo. While there were no statistically significant differences between the treatment effects for the three dose groups, the effect size for the 75 mg dose group was actually numerically less than that observed for the 50 mg dose group.

Subgroup analyses did not indicate any differences in treatment outcome as a function of age, race, or gender.

14.2 Bipolar Disorder - Monotherapy

The effectiveness of RISPERDAL CONSTA[®] for the maintenance treatment of Bipolar I Disorder was established in a multicenter, double-blind, placebo-controlled study of adult patients who met DSM-IV criteria for Bipolar Disorder Type I, who were stable on medications or experiencing an acute manic or mixed episode.

A total of 501 patients were treated during a 26-week open-label period with RISPERDAL CONSTA[®] (starting dose of 25 mg, and titrated, if deemed clinically desirable, to 37.5 mg or 50 mg; in patients not tolerating the 25 mg dose, the dose could be reduced to 12.5 mg). In the open-label phase, 303 (60%) patients were judged to be stable and were randomized to double-blind treatment with either the same dose of RISPERDAL CONSTA[®] or placebo and monitored for relapse. The primary endpoint was time to relapse to any mood episode (depression, mania, hypomania, or mixed).

Time to relapse was delayed in patients receiving RISPERDAL CONSTA[®] monotherapy as compared to placebo. The majority of relapses were due to manic rather than depressive symptoms. Based on their bipolar disorder history, subjects entering this study had had, on average, more manic episodes than depressive episodes.

14.3 Bipolar Disorder - Adjunctive Therapy

The effectiveness of RISPERDAL CONSTA[®] as an adjunct to treatment with lithium or valproate for the maintenance treatment of Bipolar Disorder was established in a multi-center, randomized, double-blind, placebo-controlled study of adult patients who met DSM-IV criteria for Bipolar Disorder Type I and who experienced at least 4 episodes of mood disorder requiring psychiatric/clinical intervention in the previous 12 months, including at least 2 episodes in the 6 months prior to the start of the study.

A total of 240 patients were treated during a 16-week open-label period with RISPERDAL CONSTA[®] (starting dose of 25 mg, and titrated, if deemed clinically desirable, to 37.5 mg or 50 mg), as adjunctive therapy in addition to continuing their treatment as usual for their bipolar disorder, which consisted of mood stabilizers (primarily lithium and valproate), antidepressants, and/or anxiolytics. All oral antipsychotics were discontinued after the first three weeks of the initial RISPERDAL CONSTA[®] injection. In the open-label phase, 124 (51.7%) were judged to

be stable for at least the last 4 weeks and were randomized to double-blind treatment with either the same dose of RISPERDAL CONSTA[®] or placebo in addition to continuing their treatment as usual and monitored for relapse during a 52-week period. The primary endpoint was time to relapse to any new mood episode (depression, mania, hypomania, or mixed).

Time to relapse was delayed in patients receiving adjunctive therapy with RISPERDAL CONSTA[®] as compared to placebo. The relapse types were about half depressive and half manic or mixed episodes.

16 HOW SUPPLIED/STORAGE AND HANDLING

RISPERDAL CONSTA[®] (risperidone) is available in dosage strengths of 12.5 mg, 25 mg, 37.5 mg, or 50 mg risperidone. It is provided as a dose pack, consisting of a vial containing the risperidone microspheres, a pre-filled syringe containing 2 mL of diluent for RISPERDAL CONSTA[®], a vial adapter, and two Terumo SurGuard[®] 3 Needles for intramuscular injection (a 21 G UTW 1-inch needle with needle protection device for deltoid administration and a 20 G TW 2-inch needle with needle protection device for gluteal administration).

12.5-mg vial/kit (NDC 50458-309-11): 41 mg (equivalent to 12.5 mg of risperidone) of a white to off-white powder provided in a vial with a violet flip-off cap (NDC 50458-309-01).

25-mg vial/kit (NDC 50458-306-11): 78 mg (equivalent to 25 mg of risperidone) of a white to off-white powder provided in a vial with a pink flip-off cap (NDC 50458-306-01).

37.5-mg vial/kit (NDC 50458-307-11): 116 mg (equivalent to 37.5 mg of risperidone) of a white to off-white powder provided in a vial with a green flip-off cap (NDC 50458-307-01).

50-mg vial/kit (NDC 50458-308-11): 152 mg (equivalent to 50 mg of risperidone) of a white to off-white powder provided in a vial with a blue flip-off cap (NDC 50458-308-01).

Storage and Handling

The entire dose pack should be stored in the refrigerator (36°-46°F; 2°-8°C) and protected from light.

If refrigeration is unavailable, RISPERDAL CONSTA[®] can be stored at temperatures not exceeding 77°F (25°C) for no more than 7 days prior to administration. Do not expose unrefrigerated product to temperatures above 77°F (25°C).

Keep out of reach of children.

17 PATIENT COUNSELING INFORMATION

Physicians are advised to discuss the following issues with patients for whom they prescribe RISPERDAL CONSTA[®].

Orthostatic Hypotension

Patients should be advised of the risk of orthostatic hypotension and instructed in nonpharmacologic interventions that help to reduce the occurrence of orthostatic hypotension (e.g., sitting on the edge of the bed for several minutes before attempting to stand in the morning and slowly rising from a seated position) [see *Warnings and Precautions* (5.7)].

Interference with Cognitive and Motor Performance

Because RISPERDAL CONSTA[®] has the potential to impair judgment, thinking, or motor skills, patients should be cautioned about operating hazardous machinery, including automobiles, until they are reasonably certain that treatment with RISPERDAL CONSTA[®] does not affect them adversely [see *Warnings and Precautions* (5.10)].

Concomitant Medication

Patients should be advised to inform their physicians if they are taking, or plan to take, any prescription or over-the-counter drugs, since there is a potential for interactions [see *Drug Interactions* (7)].

Alcohol

Patients should be advised to avoid alcohol during treatment with RISPERDAL CONSTA[®] [see *Drug Interactions* (7.1)].

Pregnancy

Advise patients to notify their healthcare provider if they become pregnant or intend to become pregnant during treatment with RISPERDAL CONSTA[®]. Advise patients that RISPERDAL CONSTA[®] may cause extrapyramidal and/or withdrawal symptoms in a neonate. Advise patients that there is a pregnancy registry that monitors pregnancy outcomes in women exposed to RISPERDAL CONSTA[®] during pregnancy [see *Use in Specific Populations* (8.1)].

Lactation

Advise breastfeeding women using RISPERDAL CONSTA[®] to monitor infants for somnolence, failure to thrive, jitteriness, and extrapyramidal symptoms (tremors and abnormal muscle movements) and to seek medical care if they notice these signs [see *Use in Specific Populations* (8.2)].

Infertility

Advise females of reproductive potential that RISPERDAL CONSTA[®] may impair fertility due to an increase in serum prolactin levels. The effects on fertility are reversible [see *Use in Specific Populations* (8.3)].

Product of Ireland

Risperidone active ingredient is manufactured by:

Janssen Pharmaceutical

Wallingstown, Little Island, County Cork, Ireland

Microspheres are manufactured by:

Alkermes, Inc.

Wilmington, Ohio

Diluent is manufactured by:

Vetter Pharma Fertigung GmbH & Co. KG

Langenargen, Germany

or

Cilag AG

Schaffhausen, Switzerland

RISPERDAL CONSTA[®] is manufactured for:

Janssen Pharmaceuticals, Inc.

Titusville, NJ 08560

© 2007 Janssen Pharmaceutical Companies

**CENTER FOR DRUG EVALUATION AND
RESEARCH**

APPLICATION NUMBER:

021346Orig1s063

OTHER REVIEW(S)

REGULATORY PROJECT MANAGER LABELING REVIEW

DRUG/NDA: Risperdal (risperidone) tablets 0.25mg, 0.5mg, 1mg, 2mg, 3mg, 4 mg (NDA 020272);
 Risperdal (risperidone) oral solution 1 mg/mL (NDA 020588)
 Risperdal M-Tabs (risperidone) orally disintegrating tablets 0.5mg, 1mg, 2mg, 3mg, 4mg (NDA 021444);
 Risperdal Consta (risperidone) Long-Acting Injection 12.5 mg, 25 mg, 37.5 mg and 50 mg (NDA 021346)

Sponsor: Janssen Pharmaceuticals, Inc.

Indications: Schizophrenia, schizoaffective disorder (Invega) & schizophrenia (Risperdal)

Pending and Last Approved Supplements:

NDA	Supplement	Dated	Type	Provides for	Status
020272 Risperdal (risperidone) Tablets	S-082	3/20/18	CBE	Addition of (b) (4), (b) (4), somnambulism" to Postmarketing Experience section	Approved 1/25/19
	S-083	7/25/18; 10/11/19 (RS)	PA	Update W&P (b) (4) (b) (4) (b) (4) and to ia" as an adverse drug reaction	Pending
	S-085	1/29/20	CBE	Addition of SJS/TENS in AR- PM section as requested in Agency SLC letter dated 12/5/19	Pending
020588 Risperdal (risperidone) Oral Solution	S-070	3/20/18	CBE	Addition of (b) (4) (b) (4), somnambulism" to Postmarketing Experience section	Approved 1/25/19
	S-071	7/25/18; 10/11/19 (RS)	PA	Update W&P (b) (4) (b) (4) (b) (4) and to ia" as an adverse drug reaction	Pending
	S-072	1/29/20	CBE	Addition of SJS/TENS in AR- PM section as requested in Agency SLC letter dated 12/5/19	Pending

021444 Risperdal M-Tabs (risperidone) Orally Disintegrating Tablets	S-056	3/20/18	CBE	Addition of (b) (4) "somniaambulism" to Postmarketing Experience section	Approved 1/25/19
	S-057	7/25/18; 10/11/19 (RS)	PA	Update W&P (b) (4) (b) (4) (b) (4) and to include (b) (4) in adverse drug reaction	Pending
	S-058	1/29/20	CBE	Addition of SJS/TENS in AR-PM section as requested in Agency SLC letter dated 12/5/19	Pending
021346 Risperdal Consta	S-060	3/20/18	CBE	Addition of (b) (4) "somniaambulism" to Postmarketing Experience section	Approved 1/25/19
	S-061	7/25/18; 10/11/19 (RS)	PA	Update W&P (b) (4) (b) (4) (b) (4) and to include "catatonia" as an adverse drug reaction	Pending
	S-063	1/29/20	CBE	Addition of SJS/TENS in AR-PM section as requested in Agency SLC letter dated 12/5/19	Pending

BACKGROUND

- SLC notification letter issued on 12/5/19, to add Stevens-Johnson syndrome and toxic epidermal necrolysis (SJS/TEN) to Adverse Reactions-Postmarketing Experience (section 6.2).
- CBE labeling supplements NDAAs 021346/S-063, 020272/S-085, 020588/S-072, and 021444/S-058 were submitted on 1/29/20 to comply with SLC notice.
- The last approved labeling was approved in Agency letter dated 1/25/19.
- This review only encompasses pending supplements NDAAs 021346/S-063, 020272/S-085, 020588/S-072 and 021444/S-058 listed above. NDAAs 021346/S-061, 020272/S-083, 020588/S-071, and 021444/S-057 submitted as Prior Approval supplements, are currently under review.

REVIEW

The following reviews were conducted on the content of labeling:

- DPV review uploaded to DARRTS 1/31/19
- DPP Chen review uploaded to DARRTS 06/13/19 to TSI 2022

CONCLUSIONS

1. Given that the sponsor incorporated the SLC language verbatim, I recommend that this review be sufficient to take an action.

2. These Changes Being Effected labeling supplements only provide for the revisions stated above when compared to the last approved labeling (approval letter dated 1/25/19).
3. I recommend that an approval letter issue for these pending supplemental applications under review.

{See appended electronic signature page}

Simran Parihar, PharmD

{See appended electronic signature page}

Kimberly Updegraff, RPh, MS, RAC
Associate Director for Labeling

Attachment: annotated labeling

114 Page(s) of Draft Labeling have been Withheld in Full as b4 (CCI/TS) immediately following this page

This is a representation of an electronic record that was signed electronically. Following this are manifestations of any and all electronic signatures for this electronic record.

/s/

SIMRAN K PARIHAR
02/04/2020 01:59:52 PM

KIMBERLY S UPDEGRAFF
02/04/2020 02:10:59 PM