

**HIGHLIGHTS OF PRESCRIBING INFORMATION**

These highlights do not include all the information needed to use FLOVENT HFA safely and effectively. See full prescribing information for FLOVENT HFA.

**FLOVENT HFA 44 mcg (fluticasone propionate 44 mcg) Inhalation Aerosol**

**FLOVENT HFA 110 mcg (fluticasone propionate 110 mcg) Inhalation Aerosol**

**FLOVENT HFA 220 mcg (fluticasone propionate 220 mcg) Inhalation Aerosol**

**FOR ORAL INHALATION**

**Initial U.S. Approval: 1994**

-----**RECENT MAJOR CHANGES**-----

Warnings and Precautions, Hypersensitivity Reactions, November 2010  
Including Anaphylaxis (5.6), Reduction in Bone Mineral Density (5.7), Drug Interactions With Strong Cytochrome P450 3A4 Inhibitors (5.11)

-----**INDICATIONS AND USAGE**-----

FLOVENT HFA is an inhaled corticosteroid indicated for:

- Maintenance treatment of asthma as prophylactic therapy in patients aged 4 years and older. (1)
- Treatment of asthma for patients requiring oral corticosteroid therapy. (1)

FLOVENT HFA is NOT indicated for the relief of acute bronchospasm. (1)

-----**DOSAGE AND ADMINISTRATION**-----

For oral inhalation only. Dosing is based on prior asthma therapy. (2)

Previous Therapy	Recommended Starting Dosage	Highest Recommended Dosage
<b>Patients aged ≥12 years</b>		
Bronchodilators alone	88 mcg twice daily	440 mcg twice daily
Inhaled corticosteroids	88-220 mcg twice daily	440 mcg twice daily
Oral corticosteroids	440 mcg twice daily	880 mcg twice daily
<b>Patients aged 4-11 years</b>	88 mcg twice daily	88 mcg twice daily

-----**DOSAGE FORMS AND STRENGTHS**-----

Inhalation aerosol with 44, 110, or 220 mcg per actuation. (3)

-----**CONTRAINDICATIONS**-----

- Primary treatment of status asthmaticus or acute episodes of asthma requiring intensive measures. (4)
- Hypersensitivity to any ingredient. (4)

-----**WARNINGS AND PRECAUTIONS**-----

- Localized infections: *Candida albicans* infection of the mouth and pharynx. Monitor patients periodically for signs of adverse effects on the oral cavity. Advise patients to rinse mouth following inhalation. (5.1)
- Immunosuppression: Potential worsening of existing tuberculosis; fungal, bacterial, viral, or parasitic infection; or ocular herpes simplex. More serious or even fatal course of chickenpox or measles in susceptible patients. Use caution in patients with above because of the potential for worsening of these infections. (5.3)
- Transferring patients from systemic corticosteroids: Risk of impaired adrenal function when transferring from oral steroids. Taper patients slowly from systemic corticosteroids if transferring to FLOVENT HFA. (5.4)
- Hypercorticism and adrenal suppression: May occur with very high dosages or at the regular dosage in susceptible individuals. If such changes occur, discontinue FLOVENT HFA slowly. (5.5)
- Hypersensitivity reactions, including anaphylaxis, may occur after administration of FLOVENT HFA. Discontinue FLOVENT HFA if such reactions occur. (4, 5.6)
- Decreases in bone mineral density: Assess bone mineral density initially and periodically thereafter in patients at risk. (5.7)
- Effect on growth: Monitor growth of pediatric patients. (5.8)
- Glaucoma and cataracts: Close monitoring is warranted. (5.9)

-----**ADVERSE REACTIONS**-----

Most common adverse reactions (incidence >3%) include upper respiratory tract infection or inflammation, throat irritation, sinusitis, dysphonia, candidiasis, cough, bronchitis, and headache. (6.1)

**To report SUSPECTED ADVERSE REACTIONS, contact GlaxoSmithKline at 1-888-825-5249 or FDA at 1-800-FDA-1088 or [www.fda.gov/medwatch](http://www.fda.gov/medwatch).**

-----**DRUG INTERACTIONS**-----

Use with strong cytochrome P450 3A4 inhibitors such as ritonavir and ketoconazole is not recommended. Systemic corticosteroid effects may occur. (7.1)

-----**USE IN SPECIFIC POPULATIONS**-----

Hepatic impairment: Monitor patients for signs of increased drug exposure. (8.6)

**See 17 for PATIENT COUNSELING INFORMATION and FDA-approved patient labeling.**

**Revised: 01/2011**

**FULL PRESCRIBING INFORMATION: CONTENTS\***

**1 INDICATIONS AND USAGE**

**2 DOSAGE AND ADMINISTRATION**

**3 DOSAGE FORMS AND STRENGTHS**

**4 CONTRAINDICATIONS**

**5 WARNINGS AND PRECAUTIONS**

5.1 Local Effects

5.2 Acute Asthma Episodes

5.3 Immunosuppression

5.4 Transferring Patients From Systemic Corticosteroid Therapy

5.5 Hypercorticism and Adrenal Suppression

5.6 Hypersensitivity Reactions, Including Anaphylaxis

5.7 Reduction in Bone Mineral Density

5.8 Effect on Growth

5.9 Glaucoma and Cataracts

5.10 Paradoxical Bronchospasm

5.11 Drug Interactions With Strong Cytochrome P450 3A4 Inhibitors

5.12 Eosinophilic Conditions and Churg-Strauss Syndrome

**6 ADVERSE REACTIONS**

6.1 Clinical Trials Experience

6.2 Postmarketing Experience

**7 DRUG INTERACTIONS**

7.1 Strong Cytochrome P450 3A4 Inhibitors

**8 USE IN SPECIFIC POPULATIONS**

8.1 Pregnancy

8.3 Nursing Mothers

8.4 Pediatric Use

8.5 Geriatric Use

8.6 Hepatic Impairment

8.7 Renal Impairment

**10 OVERDOSAGE**

**11 DESCRIPTION**

**12 CLINICAL PHARMACOLOGY**

12.1 Mechanism of Action

12.2 Pharmacodynamics

12.3 Pharmacokinetics

**13 NONCLINICAL TOXICOLOGY**

13.1 Carcinogenesis, Mutagenesis, Impairment of Fertility

13.2 Animal Toxicology and/or Pharmacology

**14 CLINICAL STUDIES**

14.1 Adult and Adolescent Patients Aged 12 Years and Older

14.2 Pediatric Patients Aged 4 to 11 Years

**16 HOW SUPPLIED/STORAGE AND HANDLING**

**17 PATIENT COUNSELING INFORMATION**

17.1 Oral Candidiasis

17.2 Status Asthmaticus and Acute Asthma Symptoms

17.3 Immunosuppression

17.4 Hypercorticism and Adrenal Suppression

17.5 Hypersensitivity Reactions, Including Anaphylaxis

17.6 Reduction in Bone Mineral Density

17.7 Reduced Growth Velocity

17.8 Ocular Effects

17.9 Use Daily for Best Effect

\*Sections or subsections omitted from the full prescribing information are not listed.

## 1 FULL PRESCRIBING INFORMATION

### 2 1 INDICATIONS AND USAGE

3 FLOVENT<sup>®</sup> HFA Inhalation Aerosol is indicated for the maintenance treatment of  
4 asthma as prophylactic therapy in patients aged 4 years and older. It is also indicated for patients  
5 requiring oral corticosteroid therapy for asthma. Many of these patients may be able to reduce or  
6 eliminate their requirement for oral corticosteroids over time.

7 FLOVENT HFA Inhalation Aerosol is NOT indicated for the relief of acute  
8 bronchospasm.

### 9 2 DOSAGE AND ADMINISTRATION

10 FLOVENT HFA should be administered by the orally inhaled route only in patients aged  
11 4 years and older. Individual patients will experience a variable time to onset and degree of  
12 symptom relief. Maximum benefit may not be achieved for 1 to 2 weeks or longer after starting  
13 treatment.

14 After asthma stability has been achieved, it is always desirable to titrate to the lowest  
15 effective dosage to reduce the possibility of side effects. For patients who do not respond  
16 adequately to the starting dosage after 2 weeks of therapy, higher dosages may provide  
17 additional asthma control. The safety and efficacy of FLOVENT HFA when administered in  
18 excess of recommended dosages have not been established.

19 The recommended starting dosage and the highest recommended dosage of FLOVENT  
20 HFA, based on prior asthma therapy, are listed in Table 1.

21  
22 **Table 1. Recommended Dosages of FLOVENT HFA Inhalation Aerosol**

**NOTE: In all patients, it is desirable to titrate to the lowest effective dosage once asthma stability is achieved.**

Previous Therapy	Recommended Starting Dosage	Highest Recommended Dosage
<b>Adult and adolescent patients (aged ≥12 years)</b>		
Bronchodilators alone	88 mcg twice daily	440 mcg twice daily
Inhaled corticosteroids	88-220 mcg twice daily <sup>a</sup>	440 mcg twice daily
Oral corticosteroids <sup>b</sup>	440 mcg twice daily	880 mcg twice daily
<b>Pediatric patients (aged 4-11 years)<sup>c</sup></b>	88 mcg twice daily	88 mcg twice daily

23 <sup>a</sup> Starting dosages above 88 mcg twice daily may be considered for patients with poorer asthma  
24 control or those who have previously required doses of inhaled corticosteroids that are in the  
25 higher range for the specific agent.

26 <sup>b</sup> For patients currently receiving chronic oral corticosteroid therapy, prednisone should be  
27 reduced no faster than 2.5 to 5 mg/day on a weekly basis beginning after at least 1 week of

28 therapy with FLOVENT HFA. Patients should be carefully monitored for signs of asthma  
29 instability, including serial objective measures of airflow, and for signs of adrenal  
30 insufficiency [see Warnings and Precautions (5.4)]. Once prednisone reduction is complete,  
31 the dosage of FLOVENT HFA should be reduced to the lowest effective dosage.

32 <sup>c</sup> Recommended pediatric dosage is 88 mcg twice daily regardless of prior therapy. A valved  
33 holding chamber and face mask may be used to deliver FLOVENT HFA to young patients.  
34

35 FLOVENT HFA should be primed before using for the first time by releasing 4 test  
36 sprays into the air away from the face, shaking well for 5 seconds before each spray. In cases  
37 where the inhaler has not been used for more than 7 days or when it has been dropped, prime the  
38 inhaler again by shaking well for 5 seconds and releasing 1 test spray into the air away from the  
39 face.

### 40 **3 DOSAGE FORMS AND STRENGTHS**

41 FLOVENT HFA is an inhalation aerosol. Each actuation delivers 44, 110, or 220 mcg of  
42 fluticasone propionate from the actuator. FLOVENT HFA 44 mcg is supplied in 10.6-g  
43 pressurized aluminum canisters, and FLOVENT HFA 110 mcg and FLOVENT HFA 220 mcg  
44 are supplied in 12-g pressurized aluminum canisters. Each canister contains 120 metered  
45 inhalations and is fitted with a counter and a dark orange oral actuator with a peach strapcap.

### 46 **4 CONTRAINDICATIONS**

47 The use of FLOVENT HFA is contraindicated in the following conditions:

- 48 • Primary treatment of status asthmaticus or other acute episodes of asthma where intensive  
49 measures are required [see Warnings and Precautions (5.2)]
- 50 • Hypersensitivity to any of the ingredients of FLOVENT HFA contraindicates their use [see  
51 Warnings and Precautions (5.6), Adverse Reactions (6.2), Description (11)]

### 52 **5 WARNINGS AND PRECAUTIONS**

#### 53 **5.1 Local Effects**

54 In clinical studies, the development of localized infections of the mouth and pharynx with  
55 *Candida albicans* has occurred in patients treated with FLOVENT HFA. When such an infection  
56 develops, it should be treated with appropriate local or systemic (i.e., oral antifungal) therapy  
57 while treatment with FLOVENT HFA continues, but at times therapy with FLOVENT HFA may  
58 need to be interrupted. Patients should rinse the mouth after inhalation of FLOVENT HFA [see  
59 Adverse Reactions (6.1)].

#### 60 **5.2 Acute Asthma Episodes**

61 FLOVENT HFA is not to be regarded as a bronchodilator and is not indicated for rapid  
62 relief of bronchospasm. Patients should be instructed to contact their physicians immediately  
63 when episodes of asthma that are not responsive to bronchodilators occur during the course of  
64 treatment with FLOVENT HFA. During such episodes, patients may require therapy with oral  
65 corticosteroids.

66 **5.3 Immunosuppression**

67 Persons who are using drugs that suppress the immune system are more susceptible to  
68 infections than healthy individuals. Chickenpox and measles, for example, can have a more  
69 serious or even fatal course in susceptible children or adults using corticosteroids. In such  
70 children or adults who have not had these diseases or been properly immunized, particular care  
71 should be taken to avoid exposure. How the dose, route, and duration of corticosteroid  
72 administration affect the risk of developing a disseminated infection is not known. The  
73 contribution of the underlying disease and/or prior corticosteroid treatment to the risk is also not  
74 known. If a patient is exposed to chickenpox, prophylaxis with varicella zoster immune globulin  
75 (VZIG) may be indicated. If a patient is exposed to measles, prophylaxis with pooled  
76 intramuscular immunoglobulin (IG) may be indicated. (See the respective package inserts for  
77 complete VZIG and IG prescribing information.) If chickenpox develops, treatment with  
78 antiviral agents may be considered.

79 Because of the potential for worsening infections, inhaled corticosteroids should be used  
80 with caution, if at all, in patients with active or quiescent tuberculosis infection of the respiratory  
81 tract; untreated systemic fungal, bacterial, viral, or parasitic infections; or ocular herpes simplex.

82 **5.4 Transferring Patients From Systemic Corticosteroid Therapy**

83 Particular care is needed for patients who have been transferred from systemically active  
84 corticosteroids to inhaled corticosteroids because deaths due to adrenal insufficiency have  
85 occurred in patients with asthma during and after transfer from systemic corticosteroids to less  
86 systemically available inhaled corticosteroids. After withdrawal from systemic corticosteroids, a  
87 number of months are required for recovery of hypothalamic-pituitary-adrenal (HPA) function.

88 Patients requiring oral corticosteroids should be weaned slowly from systemic  
89 corticosteroid use after transferring to FLOVENT HFA. In a clinical trial of 168 patients,  
90 prednisone reduction was successfully accomplished by reducing the daily prednisone dose on a  
91 weekly basis following initiation of treatment with FLOVENT HFA. Successive reduction of  
92 prednisone dose was allowed only when lung function, symptoms, and as-needed short-acting  
93 beta-agonist use were better than or comparable to that seen before initiation of prednisone dose  
94 reduction. Lung function (forced expiratory volume in 1 second [FEV<sub>1</sub>] or morning peak  
95 expiratory flow [AM PEF]), beta-agonist use, and asthma symptoms should be carefully  
96 monitored during withdrawal of oral corticosteroids. In addition to monitoring asthma signs and  
97 symptoms, patients should be observed for signs and symptoms of adrenal insufficiency such as  
98 fatigue, lassitude, weakness, nausea and vomiting, and hypotension.

99 Patients who have been previously maintained on 20 mg or more per day of prednisone  
100 (or its equivalent) may be most susceptible, particularly when their systemic corticosteroids have  
101 been almost completely withdrawn. During this period of HPA suppression, patients may exhibit  
102 signs and symptoms of adrenal insufficiency when exposed to trauma, surgery, or infection  
103 (particularly gastroenteritis) or other conditions associated with severe electrolyte loss. Although  
104 inhaled corticosteroids may provide control of asthma symptoms during these episodes, in  
105 recommended doses they supply less than normal physiological amounts of glucocorticoid

106 (cortisol) systemically and do NOT provide the mineralocorticoid activity that is necessary for  
107 coping with these emergencies.

108 During periods of stress or a severe asthma attack, patients who have been withdrawn  
109 from systemic corticosteroids should be instructed to resume oral corticosteroids immediately  
110 and to contact their physicians for further instruction. These patients should also be instructed to  
111 carry a warning card indicating that they may need supplementary systemic corticosteroids  
112 during periods of stress or a severe asthma attack.

113 Transfer of patients from systemic corticosteroid therapy to FLOVENT HFA may  
114 unmask conditions previously suppressed by the systemic corticosteroid therapy (e.g., rhinitis,  
115 conjunctivitis, eczema, arthritis, eosinophilic conditions). Some patients may experience  
116 symptoms of systemically active corticosteroid withdrawal (e.g., joint and/or muscular pain,  
117 lassitude, and depression, despite maintenance or even improvement of respiratory function).

### 118 **5.5 Hypercorticism and Adrenal Suppression**

119 Fluticasone propionate will often help control asthma symptoms with less suppression of  
120 HPA function than therapeutically equivalent oral doses of prednisone. Since fluticasone  
121 propionate is absorbed into the circulation and can be systemically active at higher doses, the  
122 beneficial effects of FLOVENT HFA in minimizing HPA dysfunction may be expected only  
123 when recommended dosages are not exceeded and individual patients are titrated to the lowest  
124 effective dose. A relationship between plasma levels of fluticasone propionate and inhibitory  
125 effects on stimulated cortisol production has been shown after 4 weeks of treatment with  
126 fluticasone propionate. Since individual sensitivity to effects on cortisol production exists,  
127 physicians should consider this information when prescribing FLOVENT HFA.

128 Because of the possibility of systemic absorption of inhaled corticosteroids, patients  
129 treated with FLOVENT HFA should be observed carefully for any evidence of systemic  
130 corticosteroid effects. Particular care should be taken in observing patients postoperatively or  
131 during periods of stress for evidence of inadequate adrenal response.

132 It is possible that systemic corticosteroid effects such as hypercorticism and adrenal  
133 suppression (including adrenal crisis) may appear in a small number of patients, particularly  
134 when FLOVENT HFA is administered at higher than recommended doses over prolonged  
135 periods of time. If such effects occur, the dosage of FLOVENT HFA should be reduced slowly,  
136 consistent with accepted procedures for reducing systemic corticosteroids and for management  
137 of asthma.

### 138 **5.6 Hypersensitivity Reactions, Including Anaphylaxis**

139 Hypersensitivity reactions, including anaphylaxis, angioedema, urticaria, and  
140 bronchospasm, may occur after administration of FLOVENT HFA [*see Contraindications (4)*].

### 141 **5.7 Reduction in Bone Mineral Density**

142 Decreases in bone mineral density (BMD) have been observed with long-term  
143 administration of products containing inhaled corticosteroids. The clinical significance of small  
144 changes in BMD with regard to long-term outcomes is unknown. Patients with major risk factors  
145 for decreased bone mineral content, such as prolonged immobilization, family history of

146 osteoporosis, postmenopausal status, tobacco use, advanced age, poor nutrition, or chronic use of  
147 drugs that can reduce bone mass (e.g., anticonvulsants, oral corticosteroids), should be monitored  
148 and treated with established standards of care.

### 149 **5.8 Effect on Growth**

150 Orally inhaled corticosteroids may cause a reduction in growth velocity when  
151 administered to pediatric patients [*see Use in Specific Populations (8.4)*]. Monitor the growth of  
152 pediatric patients receiving FLOVENT HFA routinely (e.g., via stadiometry). To minimize the  
153 systemic effects of orally inhaled corticosteroids, including FLOVENT HFA, titrate each  
154 patient's dosage to the lowest dosage that effectively controls his/her symptoms [*see Dosage and*  
155 *Administration (2)*].

### 156 **5.9 Glaucoma and Cataracts**

157 Glaucoma, increased intraocular pressure, and cataracts have been reported in patients  
158 following the long-term administration of inhaled corticosteroids, including fluticasone  
159 propionate. Therefore, close monitoring is warranted in patients with a change in vision or with a  
160 history of increased intraocular pressure, glaucoma, and/or cataracts.

### 161 **5.10 Paradoxical Bronchospasm**

162 As with other inhaled medications, bronchospasm may occur with an immediate increase  
163 in wheezing after dosing. If bronchospasm occurs following dosing with FLOVENT HFA, it  
164 should be treated immediately with a fast-acting inhaled bronchodilator. Treatment with  
165 FLOVENT HFA should be discontinued immediately and alternative therapy instituted.

### 166 **5.11 Drug Interactions With Strong Cytochrome P450 3A4 Inhibitors**

167 The use of strong cytochrome P450 3A4 (CYP3A4) inhibitors (e.g., ritonavir, atazanavir,  
168 clarithromycin, indinavir, itraconazole, nefazodone, nelfinavir, saquinavir, ketoconazole,  
169 telithromycin) with FLOVENT HFA is not recommended because increased systemic  
170 corticosteroid adverse effects may occur [*see Drug Interactions (7.1), Clinical Pharmacology*  
171 *(12.3)*].

### 172 **5.12 Eosinophilic Conditions and Churg-Strauss Syndrome**

173 In rare cases, patients on inhaled fluticasone propionate may present with systemic  
174 eosinophilic conditions. Some of these patients have clinical features of vasculitis consistent with  
175 Churg-Strauss syndrome, a condition that is often treated with systemic corticosteroid therapy.  
176 These events usually, but not always, have been associated with the reduction and/or withdrawal  
177 of oral corticosteroid therapy following the introduction of fluticasone propionate. Cases of  
178 serious eosinophilic conditions have also been reported with other inhaled corticosteroids in this  
179 clinical setting. Physicians should be alert to eosinophilia, vasculitic rash, worsening pulmonary  
180 symptoms, cardiac complications, and/or neuropathy presenting in their patients. A causal  
181 relationship between fluticasone propionate and these underlying conditions has not been  
182 established.

## 183 **6 ADVERSE REACTIONS**

184 Systemic and local corticosteroid use may result in the following:

- 185 • *Candida albicans* infection [see Warnings and Precautions (5.1)]
- 186 • Immunosuppression [see Warnings and Precautions (5.3)]
- 187 • Hypercorticism and adrenal suppression [see Warnings and Precautions (5.5)]
- 188 • Reduction in bone mineral density [see Warnings and Precautions (5.7)]
- 189 • Growth effects [see Warnings and Precautions (5.8)]
- 190 • Glaucoma and cataracts [see Warnings and Precautions (5.9)]

### 191 6.1 Clinical Trials Experience

192 Because clinical trials are conducted under widely varying conditions, adverse reaction  
193 rates observed in the clinical trials of a drug cannot be directly compared with rates in the  
194 clinical trials of another drug and may not reflect the rates observed in practice.

195 The incidence of common adverse reactions in Table 2 is based upon 2 placebo-  
196 controlled US clinical trials in which 812 adult and adolescent patients (457 females and 355  
197 males) previously treated with as-needed bronchodilators and/or inhaled corticosteroids were  
198 treated twice daily for up to 12 weeks with 2 inhalations of FLOVENT HFA 44 mcg Inhalation  
199 Aerosol, FLOVENT HFA 110 mcg Inhalation Aerosol, FLOVENT HFA 220 mcg Inhalation  
200 Aerosol (dosages of 88, 220, or 440 mcg twice daily), or placebo.

201  
202 **Table 2. Adverse Reactions With >3% Incidence in US Controlled Clinical Trials With**  
203 **FLOVENT HFA in Patients Aged ≥12 Years With Asthma Previously Receiving**  
204 **Bronchodilators and/or Inhaled Corticosteroids**

Adverse Event	FLOVENT HFA 88 mcg Twice Daily (n = 203) %	FLOVENT HFA 220 mcg Twice Daily (n = 204) %	FLOVENT HFA 440 mcg Twice Daily (n = 202) %	Placebo (n = 203) %
Ear, nose, and throat				
Upper respiratory tract infection	18	16	16	14
Throat irritation	8	8	10	5
Upper respiratory inflammation	2	5	5	1
Sinusitis/sinus infection	6	7	4	3
Hoarseness/dysphonia	2	3	6	<1
Gastrointestinal				
Candidiasis mouth/throat & non-site specific	4	2	5	<1
Lower respiratory				
Cough	4	6	4	5
Bronchitis	2	2	6	5
Neurological				
Headache	11	7	5	6

205

206 Table 2 includes all events (whether considered drug-related or nondrug-related by the  
207 investigator) that occurred at a rate of over 3% in any of the groups treated with FLOVENT HFA  
208 and were more common than in the placebo group. Less than 2% of patients discontinued from  
209 the studies because of adverse reactions. The average duration of exposure was 73 to 76 days in  
210 the active treatment groups compared with 60 days in the placebo group.

211 Additional Adverse Reactions: Other adverse reactions not previously listed, whether  
212 considered drug-related or not by the investigators, that were reported more frequently by  
213 patients with asthma treated with FLOVENT HFA compared with patients treated with placebo  
214 include the following: rhinitis, rhinorrhea/post-nasal drip, nasal sinus disorders, laryngitis,  
215 diarrhea, viral gastrointestinal infections, dyspeptic symptoms, gastrointestinal discomfort and  
216 pain, hyposalivation, musculoskeletal pain, muscle pain, muscle stiffness/tightness/rigidity,  
217 dizziness, migraines, fever, viral infections, pain, chest symptoms, viral skin infections, muscle  
218 injuries, soft tissue injuries, urinary infections.

219 Fluticasone propionate inhalation aerosol (440 or 880 mcg twice daily) was administered  
220 for 16 weeks to 168 patients with asthma requiring oral corticosteroids (Study 3). Adverse  
221 reactions not included above, but reported by >3 patients in either group treated with FLOVENT  
222 HFA and more commonly than in the placebo group included nausea and vomiting, arthralgia  
223 and articular rheumatism, and malaise and fatigue.

224 In 2 long-term studies (26 and 52 weeks), the pattern of adverse reactions in patients  
225 treated with FLOVENT HFA at dosages up to 440 mcg twice daily was similar to that observed  
226 in the 12-week studies. There were no new and/or unexpected adverse reactions with long-term  
227 treatment.

228 Pediatric Patients Aged 4 to 11 Years: FLOVENT HFA has been evaluated for safety  
229 in 56 pediatric patients who received 88 mcg twice daily for 4 weeks. Types of adverse reactions  
230 in these pediatric patients were generally similar to those observed in adults and adolescents.

## 231 **6.2 Postmarketing Experience**

232 In addition to adverse reactions reported from clinical trials, the following adverse  
233 reactions have been identified during postmarketing use of fluticasone propionate. Because these  
234 reactions are reported voluntarily from a population of uncertain size, it is not always possible to  
235 reliably estimate their frequency or establish a causal relationship to drug exposure. These events  
236 have been chosen for inclusion due to either their seriousness, frequency of reporting, or causal  
237 connection to fluticasone propionate or a combination of these factors.

238 Ear, Nose, and Throat: Aphonia, facial and oropharyngeal edema, and throat soreness  
239 and irritation.

240 Endocrine and Metabolic: Cushingoid features, growth velocity reduction in  
241 children/adolescents, hyperglycemia, osteoporosis, and weight gain.

242 Eye: Cataracts.

243 Gastrointestinal Disorders: Dental caries and tooth discoloration.

244 Psychiatry: Agitation, aggression, anxiety, depression, and restlessness. Behavioral

245 changes, including hyperactivity and irritability, have been reported very rarely and primarily in  
246 children.

247 Immune System Disorders: Immediate and delayed hypersensitivity reactions,  
248 including urticaria, anaphylaxis, rash, and angioedema and bronchospasm, have been reported.

249 Respiratory: Asthma exacerbation, chest tightness, cough, dyspnea, immediate and  
250 delayed bronchospasm, paradoxical bronchospasm, pneumonia, and wheeze.

251 Skin: Contusions, cutaneous hypersensitivity reactions, ecchymoses, and pruritus.

252 Eosinophilic Conditions: In rare cases, patients on inhaled fluticasone propionate may  
253 present with systemic eosinophilic conditions, with some patients presenting with clinical  
254 features of vasculitis consistent with Churg-Strauss syndrome, a condition that is often treated  
255 with systemic corticosteroid therapy. These events usually, but not always, have been associated  
256 with the reduction and/or withdrawal of oral corticosteroid therapy following the introduction of  
257 fluticasone propionate [see *Warnings and Precautions (5.12)*].

## 258 **7 DRUG INTERACTIONS**

### 259 **7.1 Strong Cytochrome P450 3A4 Inhibitors**

260 Fluticasone propionate is a substrate of CYP3A4. The use of strong CYP3A4 inhibitors  
261 (e.g., ritonavir, atazanavir, clarithromycin, indinavir, itraconazole, nefazodone, nelfinavir,  
262 saquinavir, ketoconazole, telithromycin) with FLOVENT HFA is not recommended because  
263 increased systemic corticosteroid adverse effects may occur.

264 A drug interaction study with fluticasone propionate aqueous nasal spray in healthy  
265 subjects has shown that ritonavir (a strong CYP3A4 inhibitor) can significantly increase plasma  
266 fluticasone propionate concentration, resulting in significantly reduced serum cortisol  
267 concentrations [see *Clinical Pharmacology (12.3)*]. During postmarketing use, there have been  
268 reports of clinically significant drug interactions in patients receiving fluticasone propionate and  
269 ritonavir, resulting in systemic corticosteroid effects including Cushing's syndrome and adrenal  
270 suppression. Therefore, coadministration of fluticasone propionate and ritonavir is not  
271 recommended unless the potential benefit to the patient outweighs the risk of systemic  
272 corticosteroid side effects.

273 Coadministration of orally inhaled fluticasone propionate (1,000 mcg) and ketoconazole  
274 (200 mg once daily) resulted in a 1.9-fold increase in plasma fluticasone propionate exposure  
275 and a 45% decrease in plasma cortisol area under the curve (AUC), but had no effect on urinary  
276 excretion of cortisol. Coadministration of fluticasone propionate and ketoconazole is not  
277 recommended unless the potential benefit to the patient outweighs the risk of systemic  
278 corticosteroid side effects.

## 279 **8 USE IN SPECIFIC POPULATIONS**

### 280 **8.1 Pregnancy**

281 Pregnancy Category C. There are no adequate and well-controlled studies with  
282 FLOVENT HFA in pregnant women. FLOVENT HFA should be used during pregnancy only if  
283 the potential benefit justifies the potential risk to the fetus.

284 **Teratogenic Effects:** Subcutaneous studies in mice at a dose approximately 0.1 times  
285 the maximum recommended human daily inhalation dose (MRHD) in adults on an mg/m<sup>2</sup> basis  
286 and in the rat at a dose approximately 0.5 times the MRHD in adults on an mg/m<sup>2</sup> basis revealed  
287 fetal toxicity characteristic of potent corticosteroid compounds, including embryonic growth  
288 retardation, omphalocele, cleft palate, and retarded cranial ossification.

289 In rabbits, fetal weight reduction and cleft palate were observed at a subcutaneous dose  
290 approximately 0.04 times the MRHD in adults on an mg/m<sup>2</sup> basis. However, no teratogenic  
291 effects were reported at oral doses up to approximately 3 times the MRHD in adults on an mg/m<sup>2</sup>  
292 basis. No fluticasone propionate was detected in the plasma in this study, consistent with the  
293 established low bioavailability following oral administration [*see Clinical Pharmacology*  
294 (12.3)].

295 Experience with oral corticosteroids since their introduction in pharmacologic, as  
296 opposed to physiologic, doses suggests that rodents are more prone to teratogenic effects from  
297 corticosteroids than humans. In addition, because there is a natural increase in corticosteroid  
298 production during pregnancy, most women will require a lower exogenous corticosteroid dose  
299 and many will not need corticosteroid treatment during pregnancy.

### 300 **8.3 Nursing Mothers**

301 It is not known whether fluticasone propionate is excreted in human breast milk.  
302 However, other corticosteroids have been detected in human milk. Subcutaneous administration  
303 to lactating rats of tritiated fluticasone propionate (approximately 0.05 times the MRHD in adults  
304 on an mg/m<sup>2</sup> basis) resulted in measurable radioactivity in milk.

305 Since there are no data from controlled trials on the use of FLOVENT HFA by nursing  
306 mothers, caution should be exercised when FLOVENT HFA is administered to a nursing  
307 woman.

### 308 **8.4 Pediatric Use**

309 The safety and effectiveness of FLOVENT HFA in children 4 years and older have been  
310 established [*see Adverse Reactions (6.1), Clinical Pharmacology (12.3), Clinical Studies (14.2)*].  
311 The safety and effectiveness of FLOVENT HFA in children younger than 4 years have not been  
312 established. Use of FLOVENT HFA in patients aged 4 to 11 years is supported by evidence from  
313 adequate and well-controlled studies in adults and adolescents 12 years and older,  
314 pharmacokinetic studies in patients aged 4 to 11 years, established efficacy of fluticasone  
315 propionate formulated as FLOVENT<sup>®</sup> DISKUS<sup>®</sup> (fluticasone propionate inhalation powder) and  
316 FLOVENT<sup>®</sup> ROTADISK<sup>®</sup> (fluticasone propionate inhalation powder) in patients aged 4 to 11  
317 years, and supportive findings with FLOVENT HFA in a study conducted in patients aged 4 to  
318 11 years.

319 **Effects on Growth:** Orally inhaled corticosteroids may cause a reduction in growth  
320 velocity when administered to pediatric patients. A reduction of growth velocity in children or  
321 teenagers may occur as a result of poorly controlled asthma or from use of corticosteroids  
322 including inhaled corticosteroids. The effects of long-term treatment of children and adolescents  
323 with inhaled corticosteroids, including fluticasone propionate, on final adult height are not

324 known.

325           Controlled clinical studies have shown that inhaled corticosteroids may cause a reduction  
326 in growth in pediatric patients. In these studies, the mean reduction in growth velocity was  
327 approximately 1 cm/year (range: 0.3 to 1.8 cm/year) and appears to depend upon dose and  
328 duration of exposure. This effect was observed in the absence of laboratory evidence of HPA  
329 axis suppression, suggesting that growth velocity is a more sensitive indicator of systemic  
330 corticosteroid exposure in pediatric patients than some commonly used tests of HPA axis  
331 function. The long-term effects of this reduction in growth velocity associated with orally  
332 inhaled corticosteroids, including the impact on final adult height, are unknown. The potential  
333 for “catch-up” growth following discontinuation of treatment with orally inhaled corticosteroids  
334 has not been adequately studied. The effects on growth velocity of treatment with orally inhaled  
335 corticosteroids for over 1 year, including the impact on final adult height, are unknown. The  
336 growth of children and adolescents receiving orally inhaled corticosteroids, including FLOVENT  
337 HFA, should be monitored routinely (e.g., via stadiometry). The potential growth effects of  
338 prolonged treatment should be weighed against the clinical benefits obtained and the risks  
339 associated with alternative therapies. To minimize the systemic effects of orally inhaled  
340 corticosteroids, including FLOVENT HFA, each patient should be titrated to the lowest dose that  
341 effectively controls his/her symptoms.

342           Since a cross study comparison in adolescent and adult patients (aged  $\geq 12$  years)  
343 indicated that systemic exposure of inhaled fluticasone propionate from FLOVENT HFA would  
344 be higher than exposure from FLOVENT ROTADISK, results from a study to assess the  
345 potential growth effects of FLOVENT ROTADISK in pediatric patients (aged 4 to 11 years) are  
346 provided.

347           A 52-week placebo-controlled study to assess the potential growth effects of fluticasone  
348 propionate inhalation powder (FLOVENT ROTADISK) at 50 and 100 mcg twice daily was  
349 conducted in the US in 325 prepubescent children (244 males and 81 females) aged 4 to 11  
350 years. The mean growth velocities at 52 weeks observed in the intent-to-treat population were  
351 6.32 cm/year in the placebo group (n = 76), 6.07 cm/year in the 50-mcg group (n = 98), and 5.66  
352 cm/year in the 100-mcg group (n = 89). An imbalance in the proportion of children entering  
353 puberty between groups and a higher dropout rate in the placebo group due to poorly controlled  
354 asthma may be confounding factors in interpreting these data. A separate subset analysis of  
355 children who remained prepubertal during the study revealed growth rates at 52 weeks of 6.10  
356 cm/year in the placebo group (n = 57), 5.91 cm/year in the 50-mcg group (n = 74), and 5.67  
357 cm/year in the 100-mcg group (n = 79). In children aged 8.5 years, the mean age of children in  
358 this study, the range for expected growth velocity is: boys – 3rd percentile = 3.8 cm/year, 50th  
359 percentile = 5.4 cm/year, and 97th percentile = 7.0 cm/year; girls – 3rd percentile = 4.2 cm/year,  
360 50th percentile = 5.7 cm/year, and 97th percentile = 7.3 cm/year.

361           The clinical significance of these growth data is not certain. Physicians should closely  
362 follow the growth of children and adolescents taking corticosteroids by any route, and weigh the  
363 benefits of corticosteroid therapy against the possibility of growth suppression if growth appears

364 slowed. Patients should be maintained on the lowest dose of inhaled corticosteroid that  
365 effectively controls their asthma.

366 Children Younger Than 4 Years: Pharmacokinetics: [see *Clinical Pharmacology*  
367 (12.3)].

368 *Pharmacodynamics:* A 12-week, double-blind, placebo-controlled, parallel-group  
369 study was conducted in children with asthma aged 1 to <4 years. Twelve-hour overnight urinary  
370 cortisol excretion after a 12-week treatment period with 88 mcg of FLOVENT HFA twice daily  
371 (n = 73) and with placebo (n = 42) were calculated. The mean and median change from baseline  
372 in urine cortisol over 12 hours were -0.7 and 0.0 mcg for FLOVENT HFA and 0.3 and -0.2 mcg  
373 for placebo, respectively.

374 In a 1-way crossover study in children aged 6 to <12 months with reactive airways  
375 disease (N = 21), serum cortisol was measured over a 12-hour dosing period. Patients received  
376 placebo treatment for a 2-week period followed by a 4-week treatment period with 88 mcg of  
377 FLOVENT HFA twice daily with an AeroChamber Plus<sup>®</sup> Valved Holding Chamber (VHC) with  
378 face mask. The geometric mean ratio of serum cortisol over 12 hours (AUC<sub>0-12 hr</sub>) following  
379 FLOVENT HFA (n = 16) versus placebo (n = 18) was 0.95 (95% CI: 0.72, 1.27).

380 *Safety:* FLOVENT HFA administered as 88 mcg twice daily has been evaluated for  
381 safety in 239 pediatric patients aged 1 to <4 years in a 12-week, double-blind, placebo-controlled  
382 study. Treatments were administered with an AeroChamber Plus VHC with face mask. In  
383 pediatric patients aged 1 to <4 years receiving FLOVENT HFA, the following events occurred  
384 with a frequency >3% and more frequently than in pediatric patients who received placebo,  
385 regardless of causality assessment: pyrexia, nasopharyngitis, upper respiratory tract infection,  
386 vomiting, otitis media, diarrhea, bronchitis, pharyngitis, and viral infection.

387 FLOVENT HFA administered as 88 mcg twice daily has also been evaluated for safety in  
388 23 pediatric patients aged 6 to 12 months in an open-label placebo-controlled study. Treatments  
389 were administered with an AeroChamber Plus VHC with face mask for 2 weeks with placebo  
390 followed by 4 weeks with active drug. There was no discernable difference in the types of  
391 adverse events reported between patients receiving placebo compared to the active drug.

392 *In Vitro Testing of Dose Delivery With Holding Chambers:* In vitro dose  
393 characterization studies were performed to evaluate the delivery of FLOVENT HFA via holding  
394 chambers with attached face masks. The studies were conducted with 2 different holding  
395 chambers (AeroChamber Plus VHC and AeroChamber Z-STAT Plus<sup>™</sup> VHC) and face masks  
396 (small and medium size) at inspiratory flow rates of 4.9, 8.0, and 12.0 L/min in combination with  
397 holding times of 0, 2, 5, and 10 seconds. The flow rates were selected to be representative of  
398 inspiratory flow rates of children aged 6 to 12 months, 2 to 5 years, and over 5 years,  
399 respectively. The mean delivered dose of fluticasone propionate through the holding chambers  
400 with face masks was lower than the 44 mcg of fluticasone propionate delivered directly from the  
401 actuator mouthpiece. The results were similar through both holding chambers (see Table 3 for  
402 data for the AeroChamber Plus VHC). The fine particle fraction (approximately 1 to 5 μm)  
403 across the flow rates used in these studies was 70% to 84% of the delivered dose, consistent with

404 the removal of the coarser fraction by the holding chamber. In contrast, the fine particle fraction  
405 for FLOVENT HFA delivered without a holding chamber typically represents 42% to 55% of the  
406 delivered dose measured at the standard flow rate of 28.3 L/min. These data suggest that, on a  
407 per kilogram basis, young children receive a comparable dose of fluticasone propionate when  
408 delivered via a holding chamber and face mask as adults do without their use.

409  
410 **Table 3. In Vitro Medication Delivery Through AeroChamber Plus Valved Holding**  
411 **Chamber With a Face Mask**

Age	Face Mask	Flow Rate (L/min)	Holding Time (seconds)	Mean Medication Delivery Through AeroChamber Plus VHC (mcg/actuation)	Body Weight 50 <sup>th</sup> Percentile (kg) <sup>a</sup>	Medication Delivered per Actuation (mcg/kg) <sup>b</sup>
6 to 12 Months	Small	4.9	0	8.3	7.5-9.9	0.8-1.1
			2	6.7		0.7-0.9
			5	7.5		0.8-1.0
			10	7.5		0.8-1.0
2 to 5 Years	Small	8.0	0	7.3	12.3-18.0	0.4-0.6
			2	6.8		0.4-0.6
			5	6.7		0.4-0.5
			10	7.7		0.4-0.6
2 to 5 Years	Medium	8.0	0	7.8	12.3-18.0	0.4-0.6
			2	7.7		0.4-0.6
			5	8.1		0.5-0.7
			10	9.0		0.5-0.7
>5 Years	Medium	12.0	0	12.3	18.0	0.7
			2	11.8		0.7
			5	12.0		0.7
			10	10.1		0.6

412 <sup>a</sup> Centers for Disease Control growth charts, developed by the National Center for Health  
413 Statistics in collaboration with the National Center for Chronic Disease Prevention and Health  
414 Promotion (2000). Ranges correspond to the average of the 50<sup>th</sup> percentile weight for boys  
415 and girls at the ages indicated.

416 <sup>b</sup> A single inhalation of FLOVENT HFA in a 70-kg adult without use of a valved holding  
417 chamber and face mask delivers approximately 44 mcg, or 0.6 mcg/kg.

418  
419 **8.5 Geriatric Use**

420 Of the total number of patients treated with FLOVENT HFA in US and non-US clinical  
421 trials, 173 were 65 years or older, 19 of which were 75 years or older. No overall differences in  
422 safety or effectiveness were observed between these patients and younger patients, and other

423 reported clinical experience has not identified differences in responses between the elderly and  
424 younger patients, but greater sensitivity of some older individuals cannot be ruled out.

### 425 **8.6 Hepatic Impairment**

426 Formal pharmacokinetic studies using FLOVENT HFA have not been conducted in  
427 patients with hepatic impairment. Since fluticasone propionate is predominantly cleared by  
428 hepatic metabolism, impairment of liver function may lead to accumulation of fluticasone  
429 propionate in plasma. Therefore, patients with hepatic disease should be closely monitored.

### 430 **8.7 Renal Impairment**

431 Formal pharmacokinetic studies using FLOVENT HFA have not been conducted in  
432 patients with renal impairment.

## 433 **10 OVERDOSAGE**

434 Chronic overdosage may result in signs/symptoms of hypercorticism [*see Warnings and*  
435 *Precautions (5.5)*]. Inhalation by healthy volunteers of a single dose of 1,760 or 3,520 mcg of  
436 fluticasone propionate CFC inhalation aerosol was well tolerated. Doses of 1,320 mcg  
437 administered to healthy human volunteers twice daily for 7 to 15 days were also well tolerated.  
438 Repeat oral doses up to 80 mg daily for 10 days in healthy volunteers and repeat oral doses up to  
439 20 mg daily for 42 days in patients were well tolerated. Adverse reactions were of mild or  
440 moderate severity, and incidences were similar in active and placebo treatment groups.

441 No deaths were seen in mice given an oral dose of 1,000 mg/kg (approximately 2,300 and  
442 11,000 times the MRHD for adults and children aged 4 to 11 years, respectively, on an mg/m<sup>2</sup>  
443 basis). No deaths were seen in rats given an oral dose of 1,000 mg/kg (approximately 4,600 and  
444 22,000 times the MRHD in adults and children aged 4 to 11 years, respectively, on an mg/m<sup>2</sup>  
445 basis).

## 446 **11 DESCRIPTION**

447 The active component of FLOVENT HFA 44 mcg Inhalation Aerosol, FLOVENT HFA  
448 110 mcg Inhalation Aerosol, and FLOVENT HFA 220 mcg Inhalation Aerosol is fluticasone  
449 propionate, a corticosteroid having the chemical name *S*-(fluoromethyl) 6 $\alpha$ ,9-difluoro-11 $\beta$ ,17-  
450 dihydroxy-16 $\alpha$ -methyl-3-oxoandrosta-1,4-diene-17 $\beta$ -carbothioate, 17-propionate and the  
451 following chemical structure:

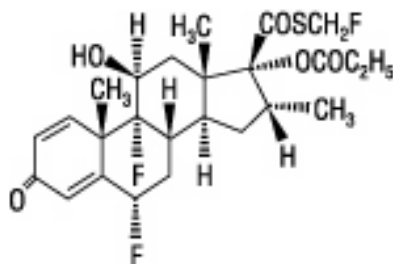

452 Fluticasone propionate is a white powder with a molecular weight of 500.6, and the  
453 empirical formula is C<sub>25</sub>H<sub>31</sub>F<sub>3</sub>O<sub>5</sub>S. It is practically insoluble in water, freely soluble in dimethyl  
454 sulfoxide and dimethylformamide, and slightly soluble in methanol and 95% ethanol.  
455

456 FLOVENT HFA 44 mcg Inhalation Aerosol, FLOVENT HFA 110 mcg Inhalation  
457 Aerosol, and FLOVENT HFA 220 mcg Inhalation Aerosol are pressurized metered-dose aerosol  
458 units fitted with a counter. FLOVENT HFA is intended for oral inhalation only. Each unit  
459 contains a microcrystalline suspension of fluticasone propionate (micronized) in propellant HFA-  
460 134a (1,1,1,2-tetrafluoroethane). It contains no other excipients.

461 After priming, each actuation of the inhaler delivers 50, 125, or 250 mcg of fluticasone  
462 propionate in 60 mg of suspension (for the 44-mcg product) or in 75 mg of suspension (for the  
463 110- and 220-mcg products) from the valve. Each actuation delivers 44, 110, or 220 mcg of  
464 fluticasone propionate from the actuator. The actual amount of drug delivered to the lung may  
465 depend on patient factors, such as the coordination between the actuation of the device and  
466 inspiration through the delivery system.

467 Each 10.6-g canister (44 mcg) and each 12-g canister (110 and 220 mcg) provides 120  
468 inhalations.

469 FLOVENT HFA should be primed before using for the first time by releasing 4 test  
470 sprays into the air away from the face, shaking well for 5 seconds before each spray. In cases  
471 where the inhaler has not been used for more than 7 days or when it has been dropped, prime the  
472 inhaler again by shaking well for 5 seconds and releasing 1 test spray into the air away from the  
473 face.

474 This product does not contain any chlorofluorocarbon (CFC) as the propellant.

## 475 **12 CLINICAL PHARMACOLOGY**

### 476 **12.1 Mechanism of Action**

477 Fluticasone propionate is a synthetic trifluorinated corticosteroid with potent anti-  
478 inflammatory activity. In vitro assays using human lung cytosol preparations have established  
479 fluticasone propionate as a human glucocorticoid receptor agonist with an affinity 18 times  
480 greater than dexamethasone, almost twice that of beclomethasone-17-monopropionate (BMP),  
481 the active metabolite of beclomethasone dipropionate, and over 3 times that of budesonide. Data  
482 from the McKenzie vasoconstrictor assay in man are consistent with these results. The clinical  
483 significance of these findings is unknown.

484 Inflammation is an important component in the pathogenesis of asthma. Corticosteroids  
485 have been shown to inhibit multiple cell types (e.g., mast cells, eosinophils, basophils,  
486 lymphocytes, macrophages, neutrophils) and mediator production or secretion (e.g., histamine,  
487 eicosanoids, leukotrienes, cytokines) involved in the asthmatic response. These anti-  
488 inflammatory actions of corticosteroids contribute to their efficacy in asthma.

489 Though effective for the treatment of asthma, corticosteroids do not affect asthma  
490 symptoms immediately. Individual patients will experience a variable time to onset and degree of  
491 symptom relief. Maximum benefit may not be achieved for 1 to 2 weeks or longer after starting  
492 treatment. When corticosteroids are discontinued, asthma stability may persist for several days or  
493 longer.

494 Studies in patients with asthma have shown a favorable ratio between topical anti-

495 inflammatory activity and systemic corticosteroid effects with recommended doses of orally  
496 inhaled fluticasone propionate. This is explained by a combination of a relatively high local anti-  
497 inflammatory effect, negligible oral systemic bioavailability (<1%), and the minimal  
498 pharmacological activity of the only metabolite detected in man.

## 499 **12.2 Pharmacodynamics**

500 Serum cortisol concentrations, urinary excretion of cortisol, and urine 6- $\beta$ -  
501 hydroxycortisol excretion collected over 24 hours in 24 healthy subjects following 8 inhalations  
502 of fluticasone propionate HFA 44, 110, and 220 mcg decreased with increasing dose. However,  
503 in patients with asthma treated with 2 inhalations of fluticasone propionate HFA 44, 110, and  
504 220 mcg twice daily for at least 4 weeks, differences in serum cortisol AUC<sub>(0-12 hr)</sub> (n = 65) and  
505 24-hour urinary excretion of cortisol (n = 47) compared with placebo were not related to dose  
506 and generally not significant. In the study with healthy volunteers, the effect of propellant was  
507 also evaluated by comparing results following the 220-mcg strength inhaler containing HFA  
508 134a propellant with the same strength of inhaler containing CFC 11/12 propellant. A lesser  
509 effect on the HPA axis with the HFA formulation was observed for serum cortisol, but not urine  
510 cortisol and 6-betahydroxy cortisol excretion. In addition, in a crossover study of children with  
511 asthma aged 4 to 11 years (N = 40), 24-hour urinary excretion of cortisol was not affected after a  
512 4-week treatment period with 88 mcg of fluticasone propionate HFA twice daily compared with  
513 urinary excretion after the 2-week placebo period. The ratio (95% CI) of urinary excretion of  
514 cortisol over 24 hours following fluticasone propionate HFA versus placebo was 0.987 (0.796,  
515 1.223).

516 The potential systemic effects of fluticasone propionate HFA on the HPA axis were also  
517 studied in patients with asthma. Fluticasone propionate given by inhalation aerosol at dosages of  
518 440 or 880 mcg twice daily was compared with placebo in oral corticosteroid-dependent patients  
519 with asthma (range of mean dose of prednisone at baseline: 13 to 14 mg/day) in a 16-week study.  
520 Consistent with maintenance treatment with oral corticosteroids, abnormal plasma cortisol  
521 responses to short cosyntropin stimulation (peak plasma cortisol <18 mcg/dL) were present at  
522 baseline in the majority of patients participating in this study (69% of patients later randomized  
523 to placebo and 72% to 78% of patients later randomized to fluticasone propionate HFA). At  
524 week 16, 8 patients (73%) on placebo compared with 14 (54%) and 13 (68%) patients receiving  
525 fluticasone propionate HFA (440 and 880 mcg twice daily, respectively) had post-stimulation  
526 cortisol levels of <18 mcg/dL.

## 527 **12.3 Pharmacokinetics**

528 Absorption: Fluticasone propionate acts locally in the lung; therefore, plasma levels do  
529 not predict therapeutic effect. Studies using oral dosing of labeled and unlabeled drug have  
530 demonstrated that the oral systemic bioavailability of fluticasone propionate is negligible (<1%),  
531 primarily due to incomplete absorption and presystemic metabolism in the gut and liver. In  
532 contrast, the majority of the fluticasone propionate delivered to the lung is systemically  
533 absorbed.

534 Distribution: Following intravenous administration, the initial disposition phase for

535 fluticasone propionate was rapid and consistent with its high lipid solubility and tissue binding.  
536 The volume of distribution averaged 4.2 L/kg.

537 The percentage of fluticasone propionate bound to human plasma proteins averages 99%.  
538 Fluticasone propionate is weakly and reversibly bound to erythrocytes and is not significantly  
539 bound to human transcortin.

540 **Metabolism:** The total clearance of fluticasone propionate is high (average, 1,093  
541 mL/min), with renal clearance accounting for less than 0.02% of the total. The only circulating  
542 metabolite detected in man is the 17 $\beta$ -carboxylic acid derivative of fluticasone propionate, which  
543 is formed through the CYP 3A4 pathway. This metabolite had less affinity (approximately  
544 1/2,000) than the parent drug for the corticosteroid receptor of human lung cytosol in vitro and  
545 negligible pharmacological activity in animal studies. Other metabolites detected in vitro using  
546 cultured human hepatoma cells have not been detected in man.

547 **Elimination:** Following intravenous dosing, fluticasone propionate showed  
548 polyexponential kinetics and had a terminal elimination half-life of approximately 7.8 hours.  
549 Less than 5% of a radiolabeled oral dose was excreted in the urine as metabolites, with the  
550 remainder excreted in the feces as parent drug and metabolites.

551 **Specific Populations: Gender:** No significant difference in clearance (CL/F) of  
552 fluticasone propionate was observed.

553 **Pediatrics:** A population pharmacokinetic analysis was performed for FLOVENT  
554 HFA using steady-state data from 4 controlled clinical trials and single-dose data from 1  
555 controlled clinical trial. The combined cohort for analysis included 269 patients (161 males and  
556 108 females) with asthma aged 6 months to 66 years who received treatment with FLOVENT  
557 HFA. Most of these subjects (n = 215) were treated with FLOVENT HFA 44 mcg given as 88  
558 mcg twice daily. FLOVENT HFA was delivered using an AeroChamber Plus VHC with a face  
559 mask to patients aged <4 years. Data from adult patients with asthma following FLOVENT HFA  
560 110 mcg given as 220 mcg twice daily (n = 15) and following FLOVENT HFA 220 mcg given  
561 as 440 mcg twice daily (n = 17) at steady state were also included. Data for 22 patients came  
562 from a single-dose crossover study of 264 mcg (6 doses of FLOVENT HFA 44 mcg) with and  
563 without AeroChamber Plus VHC in children with asthma aged 4 to 11 years.

564 Stratification of exposure data following FLOVENT HFA 88 mcg by age and study  
565 indicated that systemic exposure to fluticasone propionate at steady state was similar in children  
566 aged 6 to <12 months, children aged 1 to <4 years, and adults and adolescents aged  $\geq$ 12 years.  
567 Exposure was lower in children aged 4 to 11 years, who did not use a VHC, as shown in Table 4.  
568

569 **Table 4. Systemic Exposure to Fluticasone Propionate Following FLOVENT HFA 88 mcg**  
570 **Twice Daily**

Age	Valved Holding Chamber	N	AUC <sub>0-τ</sub> , pg•hr/mL (95% CI)	C <sub>max</sub> , pg/mL (95% CI)
6 to <12 Months	Yes	17	141 (88, 227)	19 (13, 29)
1 to <4 Years	Yes	164	143 (131, 157)	20 (18, 21)
4 to 11 Years	No	14	68 (48, 97)	11 (8, 16)
≥12 Years	No	20	149 (106, 210)	20 (15, 27)

571

572 The lower exposure to fluticasone propionate in children aged 4 to 11 years who did not  
573 use a VHC may reflect the inability to coordinate actuation and inhalation of the metered-dose  
574 inhaler. The impact of the use of a VHC on exposure to fluticasone propionate in patients aged 4  
575 to 11 years was evaluated in a single-dose crossover study with FLOVENT HFA 44 mcg given  
576 as 264 mcg. In this study, use of a VHC increased systemic exposure to fluticasone propionate  
577 (Table 5), possibly correcting for the inability to coordinate actuation and inhalation.

578

579 **Table 5. Systemic Exposure to Fluticasone Propionate Following a Single Dose of**  
580 **FLOVENT HFA 264 mcg**

Age	Valved Holding Chamber	N	AUC <sub>(0-∞)</sub> , pg•hr/mL (95% CI)	C <sub>max</sub> , pg/mL (95% CI)
4 to 11 Years	Yes	22	373 (297, 468)	61 (51, 73)
4 to 11 Years	No	21	141 (111, 178)	23 (19, 28)

581

582 There was a dose-related increase in systemic exposure in patients ≥12 years receiving  
583 higher doses of fluticasone propionate (220 and 440 mcg twice daily). The AUC<sub>0-τ</sub> in pg•hr/mL  
584 was 358 (95% CI: 272, 473) and 640 (95% CI: 477, 858), and C<sub>max</sub> in pg/mL was 47.3 (95% CI:  
585 37, 61) and 87 (95% CI: 68, 112) following fluticasone propionate 220 and 440 mcg,  
586 respectively.

587 **Hepatic and Renal Impairment:** Formal pharmacokinetic studies using FLOVENT  
588 HFA have not been conducted in patients with hepatic or renal impairment. However, since  
589 fluticasone propionate is predominantly cleared by hepatic metabolism, impairment of liver  
590 function may lead to accumulation of fluticasone propionate in plasma. Therefore, patients with  
591 hepatic disease should be closely monitored.

592 **Race:** No significant difference in clearance (CL/F) of fluticasone propionate in  
593 Caucasian, African-American, Asian, or Hispanic populations was observed.

594 **Drug Interactions: Ritonavir:** Fluticasone propionate is a substrate of CYP3A4.  
595 Coadministration of fluticasone propionate and the strong CYP3A4 inhibitor ritonavir is not  
596 recommended based upon a multiple-dose, crossover drug interaction study in 18 healthy  
597 subjects. Fluticasone propionate aqueous nasal spray (200 mcg once daily) was coadministered  
598 for 7 days with ritonavir (100 mg twice daily). Plasma fluticasone propionate concentrations

599 following fluticasone propionate aqueous nasal spray alone were undetectable (<10 pg/mL) in  
600 most subjects, and when concentrations were detectable, peak levels ( $C_{max}$ ) averaged 11.9 pg/mL  
601 (range: 10.8 to 14.1 pg/mL) and  $AUC_{(0-\tau)}$  averaged 8.43 pg•hr/mL (range: 4.2 to 18.8 pg•hr/mL).  
602 Fluticasone propionate  $C_{max}$  and  $AUC_{(0-\tau)}$  increased to 318 pg/mL (range: 110 to 648 pg/mL) and  
603 3,102.6 pg•hr/mL (range: 1,207.1 to 5,662.0 pg•hr/mL), respectively, after coadministration of  
604 ritonavir with fluticasone propionate aqueous nasal spray. This significant increase in plasma  
605 fluticasone propionate exposure resulted in a significant decrease (86%) in serum cortisol AUC.

606 **Ketoconazole:** In a placebo-controlled, crossover study in 8 healthy adult volunteers,  
607 coadministration of a single dose of orally inhaled fluticasone propionate (1,000 mcg) with  
608 multiple doses of ketoconazole (200 mg) to steady state resulted in increased plasma fluticasone  
609 propionate exposure, a reduction in plasma cortisol AUC, and no effect on urinary excretion of  
610 cortisol.

611 Following orally inhaled fluticasone propionate alone,  $AUC_{(2-last)}$  averaged 1.559  
612 ng•hr/mL (range: 0.555 to 2.906 ng•hr/mL) and  $AUC_{(2-\infty)}$  averaged 2.269 ng•hr/mL (range: 0.836  
613 to 3.707 ng•hr/mL). Fluticasone propionate  $AUC_{(2-last)}$  and  $AUC_{(2-\infty)}$  increased to 2.781 ng•hr/mL  
614 (range: 2.489 to 8.486 ng•hr/mL) and 4.317 ng•hr/mL (range: 3.256 to 9.408 ng•hr/mL),  
615 respectively, after coadministration of ketoconazole with orally inhaled fluticasone propionate.  
616 This increase in plasma fluticasone propionate concentration resulted in a decrease (45%) in  
617 serum cortisol AUC.

618 **Erythromycin:** In a multiple-dose drug interaction study, coadministration of orally  
619 inhaled fluticasone propionate (500 mcg twice daily) and erythromycin (333 mg 3 times daily)  
620 did not affect fluticasone propionate pharmacokinetics.

## 621 **13 NONCLINICAL TOXICOLOGY**

### 622 **13.1 Carcinogenesis, Mutagenesis, Impairment of Fertility**

623 Fluticasone propionate demonstrated no tumorigenic potential in mice at oral doses up to  
624 1,000 mcg/kg (approximately 2 and 10 times the MRHD in adults and children aged 4 to 11  
625 years, respectively, on an  $mg/m^2$  basis) for 78 weeks or in rats at inhalation doses up to 57  
626 mcg/kg (approximately 0.3 times and approximately equivalent to the MRHD in adults and  
627 children aged 4 to 11 years, respectively, on an  $mg/m^2$  basis) for 104 weeks.

628 Fluticasone propionate did not induce gene mutation in prokaryotic or eukaryotic cells in  
629 vitro. No significant clastogenic effect was seen in cultured human peripheral lymphocytes in  
630 vitro or in the in vivo mouse micronucleus test.

631 No evidence of impairment of fertility was observed in reproductive studies conducted in  
632 male and female rats at subcutaneous doses up to 50 mcg/kg (approximately 0.2 times the  
633 MRHD in adults on an  $mg/m^2$  basis). Prostate weight was significantly reduced at a  
634 subcutaneous dose of 50 mcg/kg.

### 635 **13.2 Animal Toxicology and/or Pharmacology**

636 Reproductive Toxicology: Subcutaneous studies in mice and rats at 45 and 100 mcg/kg  
637 (approximately 0.1 and 0.5 times the MRHD in adults on an  $mg/m^2$  basis, respectively) revealed

638 fetal toxicity characteristic of potent corticosteroid compounds, including embryonic growth  
639 retardation, omphalocele, cleft palate, and retarded cranial ossification.

640 In rabbits, fetal weight reduction and cleft palate were observed at a subcutaneous dose of  
641 4 mcg/kg (approximately 0.04 times the MRHD in adults on an mg/m<sup>2</sup> basis). However, no  
642 teratogenic effects were reported at oral doses up to 300 mcg/kg (approximately 3 times the  
643 MRHD in adults on an mg/m<sup>2</sup> basis) of fluticasone propionate. No fluticasone propionate was  
644 detected in the plasma in this study, consistent with the established low bioavailability following  
645 oral administration [*see Clinical Pharmacology (12.3)*].

646 Fluticasone propionate crossed the placenta following subcutaneous administration to  
647 mice and rats and oral administration to rabbits.

648 In animals and humans, propellant HFA-134a was found to be rapidly absorbed and  
649 rapidly eliminated, with an elimination half-life of 3 to 27 minutes in animals and 5 to 7 minutes  
650 in humans. Time to maximum plasma concentration (T<sub>max</sub>) and mean residence time are both  
651 extremely short, leading to a transient appearance of HFA-134a in the blood with no evidence of  
652 accumulation.

653 Propellant HFA-134a is devoid of pharmacological activity except at very high doses in  
654 animals (i.e., 380 to 1,300 times the maximum human exposure based on comparisons of AUC  
655 values), primarily producing ataxia, tremors, dyspnea, or salivation. These events are similar to  
656 effects produced by the structurally related CFCs, which have been used extensively in metered-  
657 dose inhalers.

## 658 **14 CLINICAL STUDIES**

### 659 **14.1 Adult and Adolescent Patients Aged 12 Years and Older**

660 Three randomized, double-blind, parallel-group, placebo-controlled, US clinical trials  
661 were conducted in 980 adult and adolescent patients (aged ≥12 years) with asthma to assess the  
662 efficacy and safety of FLOVENT HFA in the treatment of asthma. Fixed dosages of 88, 220, and  
663 440 mcg twice daily (each dose administered as 2 inhalations of the 44-, 110-, and 220-mcg  
664 strengths, respectively) and 880 mcg twice daily (administered as 4 inhalations of the 220-mcg  
665 strength) were compared with placebo to provide information about appropriate dosing to cover  
666 a range of asthma severity. Patients in these studies included those inadequately controlled with  
667 bronchodilators alone (Study 1), those already receiving inhaled corticosteroids (Study 2), and  
668 those requiring oral corticosteroid therapy (Study 3). In all 3 studies, patients (including placebo-  
669 treated patients) were allowed to use VENTOLIN<sup>®</sup> (albuterol, USP) Inhalation Aerosol as  
670 needed for relief of acute asthma symptoms. In Studies 1 and 2, other maintenance asthma  
671 therapies were discontinued.

672 Study 1 enrolled 397 patients with asthma inadequately controlled on bronchodilators  
673 alone. FLOVENT HFA was evaluated at dosages of 88, 220, and 440 mcg twice daily for 12  
674 weeks. Baseline FEV<sub>1</sub> values were similar across groups (mean 67% of predicted normal). All 3  
675 dosages of FLOVENT HFA demonstrated a statistically significant improvement in lung  
676 function as measured by improvement in AM pre-dose FEV<sub>1</sub> compared with placebo. This

677 improvement was observed after the first week of treatment, and was maintained over the 12-  
678 week treatment period.

679 At Endpoint (last observation), mean change from baseline in AM pre-dose percent  
680 predicted FEV<sub>1</sub> was greater in all 3 groups treated with FLOVENT HFA (9.0% to 11.2%)  
681 compared with the placebo group (3.4%). The mean differences between the groups treated with  
682 FLOVENT HFA 88, 220, and 440 mcg and the placebo group were statistically significant, and  
683 the corresponding 95% confidence intervals were (2.2%, 9.2%), (2.8%, 9.9%), and (4.3%,  
684 11.3%), respectively.

685 Figure 1 displays results of pulmonary function tests (mean percent change from baseline  
686 in FEV<sub>1</sub> prior to AM dose) for the recommended starting dosage of FLOVENT HFA (88 mcg  
687 twice daily) and placebo from Study 1. This trial used predetermined criteria for lack of efficacy  
688 (indicators of worsening asthma), resulting in withdrawal of more patients in the placebo group.  
689 Therefore, pulmonary function results at Endpoint (the last evaluable FEV<sub>1</sub> result, including  
690 most patients' lung function data) are also displayed.

691

692 **Figure 1. A 12-Week Clinical Trial in Patients Aged ≥12 Years Inadequately**  
693 **Controlled on Bronchodilators Alone: Mean Percent Change From Baseline in**  
694 **FEV<sub>1</sub> Prior to AM Dose (Study 1)**

695

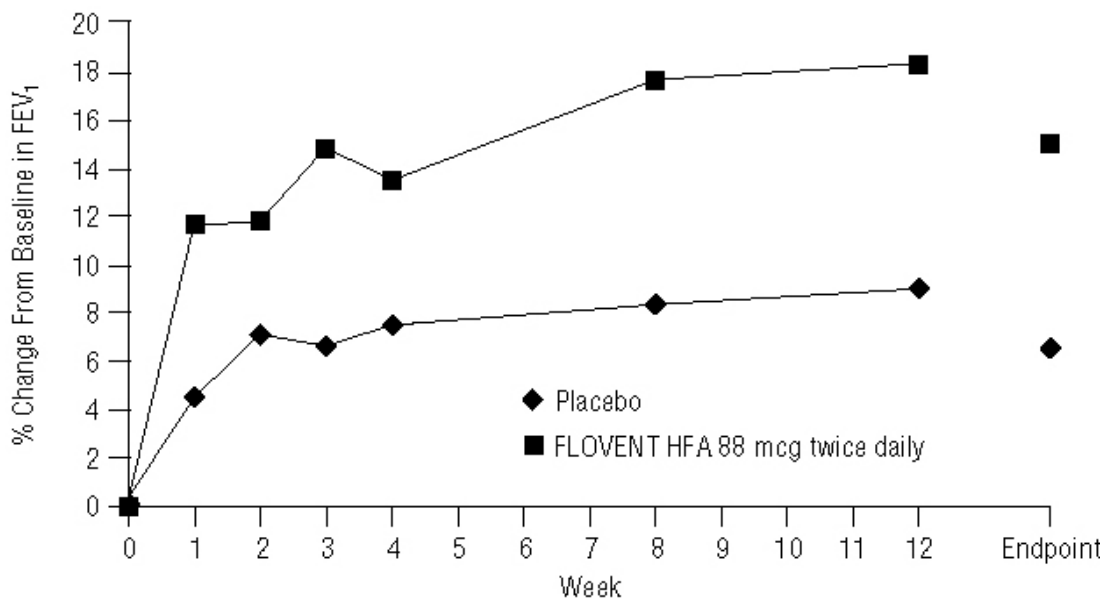

696

697

698 In Study 2, FLOVENT HFA at dosages of 88, 220, and 440 mcg twice daily was  
699 evaluated over 12 weeks of treatment in 415 patients with asthma who were already receiving an  
700 inhaled corticosteroid at a daily dose within its recommended dose range in addition to as-needed  
701 albuterol. Baseline FEV<sub>1</sub> values were similar across groups (mean 65% to 66% of predicted  
702 normal). All 3 dosages of FLOVENT HFA demonstrated a statistically significant improvement  
703 in lung function, as measured by improvement in FEV<sub>1</sub>, compared with placebo. This

704 improvement was observed after the first week of treatment and was maintained over the 12-  
705 week treatment period. Discontinuations from the study for lack of efficacy (defined by a pre-  
706 specified decrease in FEV<sub>1</sub> or PEF, or an increase in use of VENTOLIN or nighttime  
707 awakenings requiring treatment with VENTOLIN) were lower in the groups treated with  
708 FLOVENT HFA (6% to 11%) compared with placebo (50%).

709 At Endpoint (last observation), mean change from baseline in AM pre-dose percent  
710 predicted FEV<sub>1</sub> was greater in all 3 groups treated with FLOVENT HFA (2.2% to 4.6%)  
711 compared with the placebo group (-8.3%). The mean differences between the groups treated with  
712 FLOVENT HFA 88, 220, and 440 mcg and the placebo group were statistically significant, and  
713 the corresponding 95% confidence intervals were (7.1%, 13.8%), (8.2%, 14.9%), and (9.6%,  
714 16.4%), respectively.

715 Figure 2 displays the mean percent change from baseline in FEV<sub>1</sub> from Week 1 through  
716 Week 12. This study also used predetermined criteria for lack of efficacy, resulting in withdrawal  
717 of more patients in the placebo group; therefore, pulmonary function results at Endpoint are also  
718 displayed.

719

720 **Figure 2. A 12-Week Clinical Trial in Patients Aged ≥12 Years Already**  
721 **Receiving Daily Inhaled Corticosteroids: Mean Percent Change From**  
722 **Baseline in FEV<sub>1</sub> Prior to AM Dose (Study 2)**

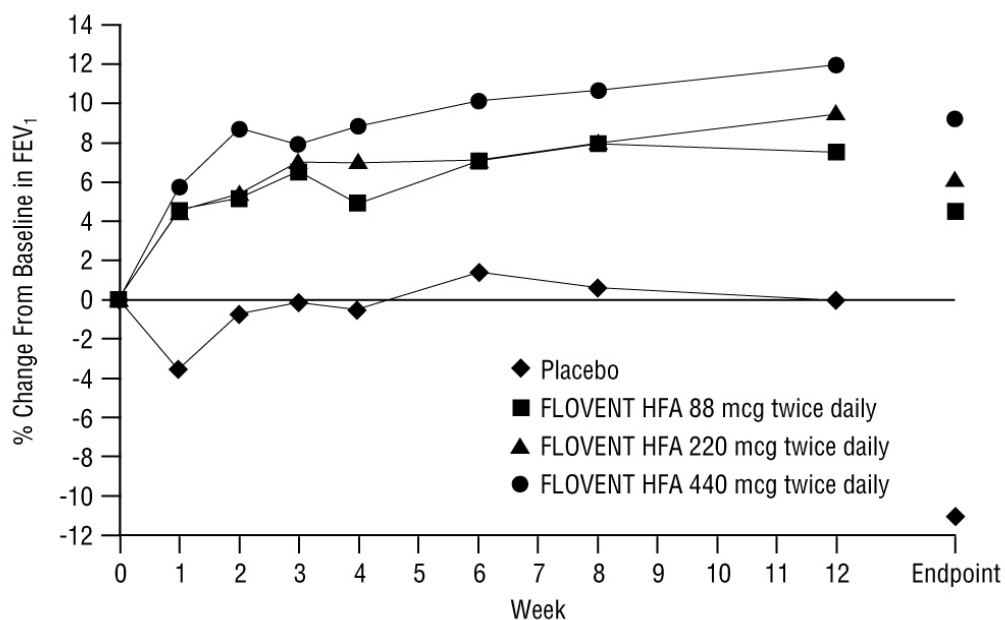

723

724

725 In both studies, use of VENTOLIN, AM and PM PEF, and asthma symptom scores  
726 showed numerical improvement with FLOVENT HFA compared with placebo.

727 Study 3 enrolled 168 patients with asthma requiring oral prednisone therapy (average  
728 baseline daily prednisone dose ranged from 13 to 14 mg). FLOVENT HFA at dosages of 440

729 and 880 mcg twice daily was evaluated over a 16-week treatment period. Baseline FEV<sub>1</sub> values  
730 were similar across groups (mean 59% to 62% of predicted normal). Over the course of the  
731 study, patients treated with either dosage of FLOVENT HFA required a statistically significantly  
732 lower mean daily oral prednisone dose (6 mg) compared with placebo-treated patients (15 mg).  
733 Both dosages of FLOVENT HFA enabled a larger percentage of patients (59% and 56% in the  
734 groups treated with FLOVENT HFA 440 and 880 mcg, respectively, twice daily) to eliminate  
735 oral prednisone as compared with placebo (13%) (see Figure 3). There was no efficacy  
736 advantage of FLOVENT HFA 880 mcg twice daily compared with 440 mcg twice daily.  
737 Accompanying the reduction in oral corticosteroid use, patients treated with either dosage of  
738 FLOVENT HFA had statistically significantly improved lung function, fewer asthma symptoms,  
739 and less use of VENTOLIN Inhalation Aerosol compared with the placebo-treated patients.  
740

741 **Figure 3. A 16-Week Clinical Trial in Patients Aged ≥12 Years Requiring Chronic**  
742 **Oral Prednisone Therapy: Change in Maintenance Prednisone Dose**

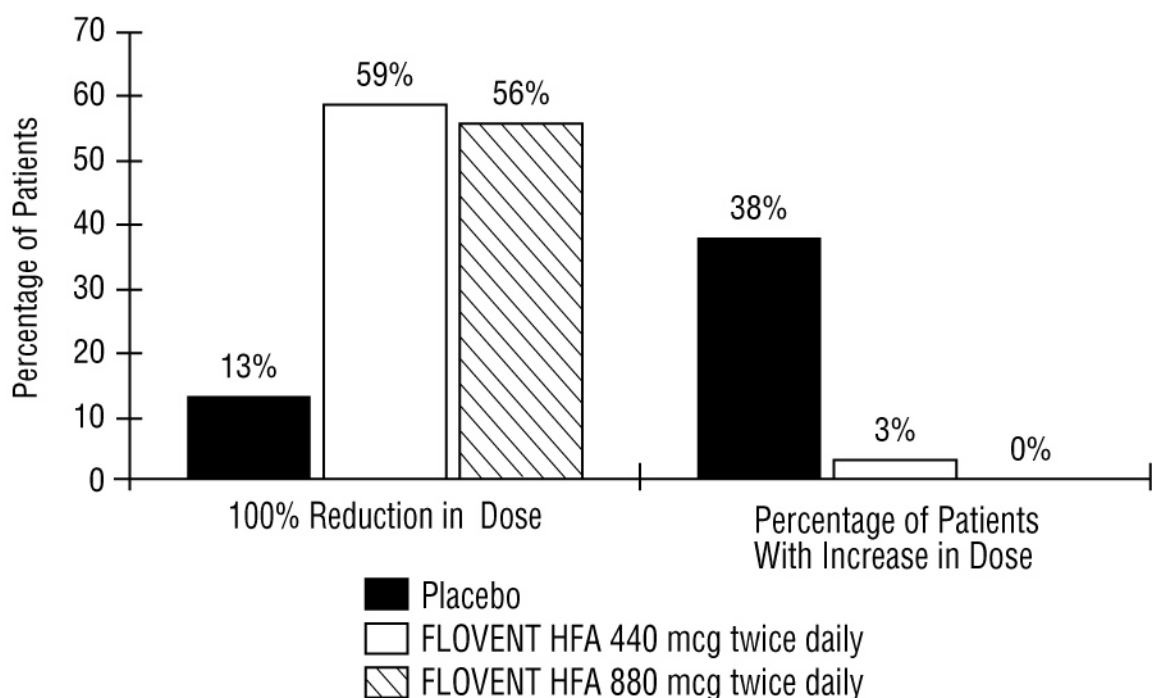

743  
744 Two long-term safety studies (Study 4 and Study 5) of ≥6 months' duration were  
745 conducted in 507 adult and adolescent patients with asthma. Study 4 was designed to monitor the  
746 safety of 2 doses of FLOVENT HFA, while Study 5 compared fluticasone propionate HFA with  
747 fluticasone propionate CFC. Study 4 enrolled 182 patients who were treated daily with low to  
748 high doses of inhaled corticosteroids, beta-agonists (short-acting [as needed or regularly  
749 scheduled] or long-acting), theophylline, inhaled cromolyn or nedocromil sodium, leukotriene  
750 receptor antagonists, or 5-lipoxygenase inhibitors at baseline. FLOVENT HFA at dosages of 220  
751 and 440 mcg twice daily was evaluated over a 26-week treatment period in 89 and 93 patients,

752 respectively. Study 5 enrolled 325 patients who were treated daily with moderate to high doses  
753 of inhaled corticosteroids, with or without concurrent use of salmeterol or albuterol, at baseline.  
754 Fluticasone propionate HFA at a dosage of 440 mcg twice daily and fluticasone propionate CFC  
755 at a dosage of 440 mcg twice daily were evaluated over a 52-week treatment period in 163 and  
756 162 patients, respectively. Baseline FEV<sub>1</sub> values were similar across groups (mean 81% to 84%  
757 of predicted normal). Throughout the 52-week treatment period, asthma control was maintained  
758 with both formulations of fluticasone propionate compared with baseline. In both studies, none  
759 of the patients were withdrawn due to lack of efficacy.

#### 760 **14.2 Pediatric Patients Aged 4 to 11 Years**

761 A 12-week clinical trial conducted in 241 pediatric patients with asthma was supportive  
762 of efficacy but inconclusive due to measurable levels of fluticasone propionate in 6/48 (13%) of  
763 the plasma samples from patients randomized to placebo. Efficacy in patients aged 4 to 11 years  
764 is extrapolated from adult data with FLOVENT HFA and other supporting data [*see Use in*  
765 *Specific Populations (8.4)*].

### 766 **16 HOW SUPPLIED/STORAGE AND HANDLING**

767 FLOVENT HFA 44 mcg Inhalation Aerosol is supplied in 10.6-g pressurized aluminum  
768 canisters containing 120 metered inhalations in boxes of 1 (NDC 0173-0718-20).

769 FLOVENT HFA 110 mcg Inhalation Aerosol is supplied in 12-g pressurized aluminum  
770 canisters containing 120 metered inhalations in boxes of 1 (NDC 0173-0719-20).

771 FLOVENT HFA 220 mcg Inhalation Aerosol is supplied in 12-g pressurized aluminum  
772 canisters containing 120 metered inhalations in boxes of 1 (NDC 0173-0720-20).

773 Each canister is fitted with a counter and a dark orange oral actuator with a peach  
774 strapcap packaged within a plastic-coated, moisture-protective foil pouch and patient's  
775 instructions. The moisture-protective foil pouch also contains a desiccant that should be  
776 discarded when the pouch is opened.

777 The dark orange actuator supplied with FLOVENT HFA should not be used with any  
778 other product canisters, and actuators from other products should not be used with a FLOVENT  
779 HFA canister.

780 The correct amount of medication in each inhalation cannot be assured after the counter  
781 reads 000, even though the canister is not completely empty and will continue to operate. The  
782 inhaler should be discarded when the counter reads 000.

783 Keep out of reach of children. Avoid spraying in eyes.

784 Contents Under Pressure: Do not puncture. Do not use or store near heat or open flame.  
785 Exposure to temperatures above 120°F may cause bursting. Never throw into fire or incinerator.

786 Store at 25°C (77°F); excursions permitted from 15° to 30°C (59° to 86°F). Store the  
787 inhaler with the mouthpiece down. For best results, the inhaler should be at room temperature  
788 before use. SHAKE WELL BEFORE USING.

789 FLOVENT HFA does not contain CFCs as the propellant.

790 **17 PATIENT COUNSELING INFORMATION**

791 *See FDA-Approved Patient Labeling tear-off leaflet below.*

792 **17.1 Oral Candidiasis**

793 Patients should be advised that localized infections with *Candida albicans* have occurred  
794 in the mouth and pharynx in some patients. If oropharyngeal candidiasis develops, it should be  
795 treated with appropriate local or systemic (i.e., oral antifungal) therapy while still continuing  
796 therapy with FLOVENT HFA, but at times therapy with FLOVENT HFA may need to be  
797 temporarily interrupted under close medical supervision. Rinsing the mouth after inhalation is  
798 advised.

799 **17.2 Status Asthmaticus and Acute Asthma Symptoms**

800 Patients should be advised that FLOVENT HFA is not a bronchodilator and is not  
801 intended for use as rescue medication for acute asthma exacerbations. Acute asthma symptoms  
802 should be treated with an inhaled, short-acting beta<sub>2</sub>-agonist such as albuterol. Patients should be  
803 instructed to contact their physicians immediately if there is deterioration of their asthma.

804 **17.3 Immunosuppression**

805 Patients who are on immunosuppressant doses of corticosteroids should be warned to  
806 avoid exposure to chickenpox or measles and if they are exposed to consult their physicians  
807 without delay. Patients should be informed of potential worsening of existing tuberculosis,  
808 fungal, bacterial, viral, or parasitic infections, or ocular herpes simplex.

809 **17.4 Hypercorticism and Adrenal Suppression**

810 Patients should be advised that FLOVENT HFA may cause systemic corticosteroid  
811 effects of hypercorticism and adrenal suppression. Additionally, patients should be instructed  
812 that deaths due to adrenal insufficiency have occurred during and after transfer from systemic  
813 corticosteroids. Patients should taper slowly from systemic corticosteroids if transferring to  
814 FLOVENT HFA.

815 **17.5 Hypersensitivity Reactions, Including Anaphylaxis**

816 Patients should be advised that hypersensitivity reactions including anaphylaxis,  
817 angioedema, urticaria, and bronchospasm may occur after administration of FLOVENT HFA.  
818 Patients should discontinue FLOVENT HFA if such reactions occur.

819 **17.6 Reduction in Bone Mineral Density**

820 Patients who are at an increased risk for decreased BMD should be advised that the use of  
821 corticosteroids may pose an additional risk.

822 **17.7 Reduced Growth Velocity**

823 Patients should be informed that orally inhaled corticosteroids, including FLOVENT  
824 HFA, may cause a reduction in growth velocity when administered to pediatric patients.  
825 Physicians should closely follow the growth of children and adolescents taking corticosteroids by  
826 any route.

827 **17.8 Ocular Effects**

828 Long-term use of inhaled corticosteroids may increase the risk of some eye problems  
829 (cataracts or glaucoma); regular eye examinations should be considered.

830 **17.9 Use Daily for Best Effect**

831 Patients should use FLOVENT HFA at regular intervals as directed. Individual patients  
832 will experience a variable time to onset and degree of symptom relief and the full benefit may  
833 not be achieved until treatment has been administered for 1 to 2 weeks or longer. Patients should  
834 not increase the prescribed dosage but should contact their physicians if symptoms do not  
835 improve or if the condition worsens. Patients should be instructed not to stop use of FLOVENT  
836 HFA abruptly. Patients should contact their physicians immediately if they discontinue use of  
837 FLOVENT HFA.

838

839 DISKUS, FLOVENT, ROTADISK, and VENTOLIN are registered trademarks of  
840 GlaxoSmithKline.

841 AeroChamber Plus is a registered trademark and AeroChamber Z-STAT Plus is a trademark of  
842 Monaghan Medical Corp. or an affiliate of Monaghan Medical Corp.

843

844



845

846 GlaxoSmithKline

847 Research Triangle Park, NC 27709

848

849 ©2011, GlaxoSmithKline. All rights reserved.

850

851 January 2011

852 FLH:3PI

853

854

855 **PHARMACIST—DETACH HERE AND GIVE LEAFLET TO PATIENT**

856

857

**Patient Information**

858

859 **FLOVENT<sup>®</sup> [flō'vent] HFA 44 mcg**  
860 **(fluticasone propionate 44 mcg)**  
861 **Inhalation Aerosol**

862

863 **FLOVENT<sup>®</sup> HFA 110 mcg**  
864 **(fluticasone propionate 110 mcg)**  
865 **Inhalation Aerosol**

866

867

867 **FLOVENT<sup>®</sup> HFA 220 mcg**  
868 **(fluticasone propionate 220 mcg)**

869 **Inhalation Aerosol**

870  
871 **FOR ORAL INHALATION ONLY**

872  
873 Read this leaflet carefully before you start to use FLOVENT HFA Inhalation Aerosol.

874 Keep this leaflet because it has important summary information about FLOVENT HFA. This  
875 leaflet does not contain all the information about your medicine. If you have any questions or are  
876 not sure about something, you should ask your doctor or pharmacist.

877 Read the new leaflet that comes with each refill of your prescription because there may be  
878 new information.

879  
880 **What is FLOVENT HFA?**

881 FLOVENT HFA contains a medicine called fluticasone propionate, which is a synthetic  
882 corticosteroid. Corticosteroids are natural substances found in the body that help fight  
883 inflammation. Corticosteroids are used to treat asthma because they reduce airway inflammation.

884 FLOVENT HFA is used to treat asthma in patients 4 years and older. When inhaled regularly,  
885 FLOVENT HFA also helps to prevent symptoms of asthma.

886 FLOVENT HFA comes in 3 strengths. Your doctor has prescribed the one that is best for your  
887 condition.

888  
889 **Who should not use FLOVENT HFA?**

890 Do not use FLOVENT HFA if you:

- 891 • are allergic to any of the ingredients in FLOVENT HFA or other inhaled corticosteroids. See  
892 “What are the ingredients in FLOVENT HFA?” below.
- 893 • have an acute asthma attack or status asthmaticus. **FLOVENT HFA is not a bronchodilator**  
894 **and should not be used to give you fast relief from your breathing problems during an**  
895 **asthma attack.** Always use a short-acting bronchodilator (rescue medicine), such as  
896 albuterol inhaler, during a sudden asthma attack. You must take FLOVENT HFA at regular  
897 times as recommended by your doctor, and not as an emergency medicine.

898  
899 **What should I tell my doctor before taking FLOVENT HFA?**

900 **Tell your doctor if you:**

- 901 • have liver problems.
- 902 • have been exposed to chickenpox or measles.
- 903 • have any other medical conditions.
- 904 • are pregnant or planning to become pregnant. It is not known if FLOVENT HFA will harm  
905 your unborn baby.
- 906 • are breastfeeding a baby. It is not known if FLOVENT HFA passes into your breast milk.

907 Tell your doctor about all the medicines you take including prescription and non-prescription

908 medicines, vitamins, and herbal supplements. FLOVENT HFA may affect the way other  
909 medicines work, and other medicines may affect how FLOVENT HFA works. Especially, tell  
910 your doctor if you take:

- 911 • a medicine containing ritonavir (commonly used to treat HIV infection or AIDS). The anti-  
912 HIV medicines NORVIR<sup>®</sup> (ritonavir capsules) Soft Gelatin, NORVIR (ritonavir oral  
913 solution), and KALETRA<sup>®</sup> (lopinavir/ritonavir) tablets contain ritonavir.
- 914 • any other corticosteroid medicines.
- 915 • ketoconazole (NIZORAL<sup>®</sup>), an antifungal medicine.

916

#### 917 **How should I use FLOVENT HFA?**

- 918 1. It is important that you inhale each dose as your doctor has prescribed. The prescription label  
919 provided by your pharmacist will usually tell you what dose to take and how often. If it  
920 doesn't or if you aren't sure, ask your doctor or pharmacist. **DO NOT** inhale more doses or  
921 use your FLOVENT HFA more often than your doctor has prescribed.
- 922 2. It may take 1 to 2 weeks or longer for this medicine to work, and it is very important that you  
923 use it regularly. **Do not stop taking FLOVENT HFA, even if you are feeling better,**  
924 **unless your doctor tells you to.**
- 925 3. If you miss a dose, just take your next scheduled dose when it is due. **Do not double the**  
926 **dose.**
- 927 4. Your doctor may prescribe additional medicine (such as fast-acting bronchodilators) for  
928 emergency relief if a sudden asthma attack occurs. Contact your doctor if:  
929 • an asthma attack does not respond to the additional medicine or  
930 • you need more of the additional medicine than usual.
- 931 5. If you also use another medicine by inhalation, you should ask your doctor for instructions on  
932 when to use it while you are also using FLOVENT HFA.
- 933 6. Children should use FLOVENT HFA with an adult's help, as instructed by the child's  
934 healthcare provider. A valved holding chamber (a kind of spacer) and face mask may be used  
935 to deliver FLOVENT HFA to young patients.

936

#### 937 **What should I avoid while taking FLOVENT HFA?**

938 If you have not had or not been vaccinated against chickenpox, measles, or active  
939 tuberculosis, you should stay away from people who are infected.

940

#### 941 **What are the possible side effects of FLOVENT HFA?**

942 FLOVENT HFA can cause serious side effects, including:

- 943 • **fungal infections (thrush) in your mouth and throat.** Tell your doctor if you have any  
944 redness or white-colored coating in your mouth
- 945 • **decreased ability to fight infections.** Symptoms of infection may include: fever, pain, aches,

946 chills, feeling tired, nausea and vomiting. Tell your doctor about any signs of infection while  
947 you use FLOVENT HFA.

- 948 • **decreased adrenal function (adrenal insufficiency).** Symptoms of decreased adrenal  
949 function include tiredness, weakness, nausea and vomiting, and low blood pressure.  
950 Decreased adrenal function can lead to death
- 951 • **allergic reaction (anaphylaxis).** Call your doctor and stop FLOVENT HFA right away if  
952 you have any symptoms of an allergic reaction:
  - 953 • swelling of the face, throat and tongue
  - 954 • hives
  - 955 • rash
  - 956 • breathing problems
- 957 • **lower bone mineral density.** This may be a problem for people who already have a higher  
958 chance of low bone density (osteoporosis).
- 959 • **slow growth in children.** The growth of children using FLOVENT HFA should be checked  
960 regularly.
- 961 • **eye problems including glaucoma and cataracts.** Tell your doctor about any vision  
962 changes while using FLOVENT HFA. Your doctor may tell you to have your eyes checked.
- 963 • **increased wheezing (bronchospasm).** Increased wheezing can happen right away after  
964 using FLOVENT HFA. Always have a rescue inhaler with you to treat sudden wheezing.

965 Tell your doctor right away if you have any of the serious side effects listed above or if you  
966 have worsening lung symptoms.

967 The most common side effects of FLOVENT HFA include:

- 968 • a cold or upper respiratory tract infection
- 969 • throat irritation
- 970 • headache
- 971 • fever
- 972 • diarrhea
- 973 • ear infection

974 Tell your doctor if you have any side effects that bother you or that do not go away. These are  
975 not all the possible side effects of FLOVENT HFA. For more information ask your doctor or  
976 pharmacist.

977 Call your doctor for medical advice about side effects. You may report side effects to FDA at  
978 1-800-FDA-1088 or 1-800-332-1088.

979

#### 980 **How should I store FLOVENT HFA?**

981 Store FLOVENT HFA at room temperature between 59° and 86°F (15°-30°C). Store the  
982 inhaler with the mouthpiece down. For best results, the inhaler should be at room temperature  
983 before use.

984

985 **Keep FLOVENT HFA and all medicines out of the reach of children.**

986

987 This Patient Information leaflet summarizes the most important information about FLOVENT  
988 HFA. If you would like more information, talk with your healthcare provider. You can ask your  
989 pharmacist or doctor for information about FLOVENT HFA that is written for health  
990 professionals. You can also contact the company that makes FLOVENT HFA (toll free) at 1-  
991 888-825-5249.

992

993 **What are the ingredients in FLOVENT HFA?**

994 Active ingredient: fluticasone propionate (micronized)

995 Inactive ingredient: propellant HFA-134a

996

997

### Instructions for Using FLOVENT HFA

998 **The parts of your FLOVENT HFA**

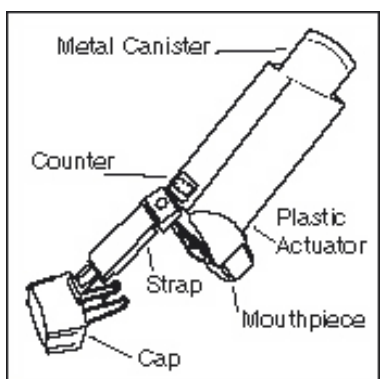

999  
1000

**Figure 1**

1001 There are 2 main parts to your FLOVENT HFA  
1002 inhaler—the metal canister that holds the medicine and the  
1003 dark orange plastic actuator that sprays the medicine from  
1004 the canister (see Figure 1).

1005 The canister has a counter to show how many sprays of  
1006 medicine you have left. The number shows through a  
1007 window in the back of the actuator. The counter starts at  
1008 124. The number will count down by 1 each time you spray  
1009 the inhaler. The counter will stop counting at 000.

1010 **Never try to change the numbers or take the counter off the metal canister.** The counter  
1011 cannot be reset, and it is permanently attached to the canister.

1012 The mouthpiece of the actuator is covered by a cap. A strap on this cap keeps it attached to the  
1013 actuator.

1014 **Do not use the actuator with a canister of medicine from any other inhaler. And do not**  
1015 **use a FLOVENT HFA canister with an actuator from any other inhaler.**

1016

1017 **Using your FLOVENT HFA**

- 1018 • The inhaler should be at room temperature before you use it.
- 1019 • Take your FLOVENT HFA inhaler out of the moisture-protective foil pouch just before you  
1020 use it for the first time. Safely throw away the foil pouch and the drying packet that comes  
1021 inside the pouch.

1022 • **Priming the inhaler:**

1023 **Before you use FLOVENT HFA for the first time, you must prime the inhaler so that**  
1024 **you will get the right amount of medicine when you use it.** To prime the inhaler, take the

1025 cap off the mouthpiece and shake the inhaler well for 5 seconds. Then spray the inhaler into  
1026 the air away from your face. **Avoid spraying in eyes.** Shake and spray the inhaler like this 3  
1027 more times to finish priming it. The counter should now read 120.

1028 You must prime the inhaler again if you have not used it in more than 7 days or if you  
1029 drop it. Take the cap off the mouthpiece and shake the inhaler well for 5 seconds. Then spray  
1030 it 1 time into the air away from your face.

- 1031 • If a child needs help using the inhaler, an adult should help the child use the inhaler with or  
1032 without a valved holding chamber, which may also be attached to a face mask. The adult  
1033 should follow the instructions that came with the valved holding chamber. An adult should  
1034 watch a child use the inhaler to be sure it is used correctly.

1035  
1036 Read the following 7 steps before using FLOVENT HFA and follow them at each use. If you  
1037 have any questions, ask your doctor or pharmacist.

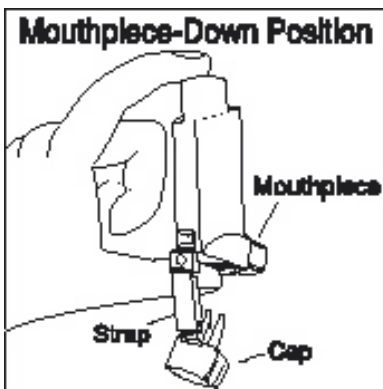

1038  
1039 **Figure 2**  
1040

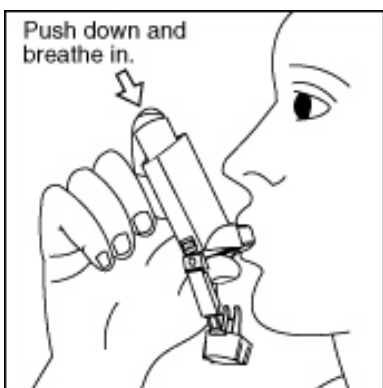

1041  
1042 **Figure 3**

- 1043 1. **Take the cap off the mouthpiece of the actuator** (see  
1044 Figure 2).  
1045 Look inside the mouthpiece for foreign objects, and  
1046 take out any you see.  
1047 Make sure the canister fits firmly in the actuator.  
1048 **Shake the inhaler well** for 5 seconds.  
1049 2. Hold the inhaler with the mouthpiece down (see Figure  
1050 2). **Breathe out through your mouth** and push as  
1051 much air from your lungs as you can. Put the  
1052 mouthpiece in your mouth and close your lips around it.  
1053 3. Push the top of the canister all the way down while you  
1054 breathe in deeply and slowly through your mouth (see  
1055 Figure 3).  
1056 Right after the spray comes out, take your finger off  
1057 the canister. After you have breathed in all the way,  
1058 take the inhaler out of your mouth and close your  
1059 mouth.  
1060 4. **Hold your breath as long as you can**, up to 10  
1061 seconds. Then breathe normally.  
1062 5. **Wait about 30 seconds and shake the inhaler well** for  
1063 5 seconds. Repeat steps 2 through 4.  
1064 6. After you finish taking this medicine, rinse your mouth

1065

1066 with water. Spit out the water. Do not swallow it.

- 1067 7. Put the cap back on the mouthpiece after each time you  
1068 use the inhaler. Make sure it snaps firmly into place.

1069 **Cleaning your FLOVENT HFA**

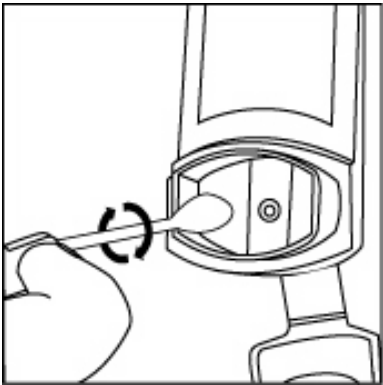

1070 **Figure 4**  
1071

1072 Clean the inhaler at least once a week after your  
1073 evening dose. It is important to keep the canister and  
1074 plastic actuator clean so the medicine will not build-up  
1075 and block the spray.

- 1076 1. Take the cap off the mouthpiece. The strap on the cap  
1077 will stay attached to the actuator. Do not take the  
1078 canister out of the plastic actuator.
- 1079 2. Use a clean cotton swab dampened with water to clean  
1080 the small circular opening where the medicine sprays  
1081 out of the canister. Gently twist the swab in a circular  
1082 motion to take off any medicine (see Figure 4). Repeat  
1083 with a new swab dampened with water to take off any  
1084 medicine still at the opening.
- 1085 3. Wipe the inside of the mouthpiece with a clean tissue  
1086 dampened with water. Let the actuator air-dry  
1087 overnight.
- 1088 4. Put the cap back on the mouthpiece after the actuator  
1089 has dried.

1090 **Replacing your FLOVENT HFA**

- 1091 • **When the counter reads 020**, you should refill your prescription or ask your doctor if you  
1092 need a refill of your prescription.
- 1093 • **When the counter reads 000**, throw the inhaler away. You should not keep using the inhaler  
1094 because you will not receive the right amount of medicine.
- 1095 • **Do not use the inhaler** after the expiration date, which is on the packaging it comes in.  
1096

1097 FLOVENT is a registered trademark of GlaxoSmithKline.

1098 The other brands listed are trademarks of their respective owners and are not trademarks of  
1099 GlaxoSmithKline. The makers of these brands are not affiliated with and do not endorse  
1100 GlaxoSmithKline or its products.

1101

1102



1103

1104 GlaxoSmithKline

1105 Research Triangle Park, NC 27709  
1106  
1107 ©2010, GlaxoSmithKline. All rights reserved.  
1108  
1109 November 2010  
1110 FLH:2PIL