



FRONT

128 CODE = 080440

090177e189be95e0\Final\Final On: 29-Sep-2016 19:42

PRODUCTION

(NOT COLOR ACCURATE)

Job Information	Color Legend
Date 27-SEP-2016 PASS # 1 Component # PAA080440.FDA01 Drawing # (b) (4)-50014435v01	(b) (4)
Identification	
(b) (4)	Printer & User Notes
	PRINTER TO REPLACE ALL FPO CODES WITH SCANNABLE ART. PRINTER RESPONSIBLE FOR ALL TRAPPING, BLEEDS, COATINGS AND RESOLUTION. PRINTER AND USERS RESPONSIBLE FOR PROPER LICENSING OF ALL FONTS USED IN THIS ARTWORK.

DRUG FACTS TEXT DEFINED	TYPE SIZE
• HEADINGS	4.5 pt
• SUBHEADINGS/BODY TEXT	4.5 pt
• LEADING	4.5 pt
• BULLETS	3.5 pt
• SPACE BEFORE BULLET	2 ems
• WARNING BOX LINE, HAIRLINES	N/A



090177e189c024ad\Final\Final On: 30-Sep-2016 19:47

PRODUCTION

(NOT COLOR ACCURATE)

Job Information	Color Legend
Date 30-SEP-2016 PASS # 2 Component # PAA080930.FDA01 Drawing # (b) (4)-50038548v01	(b) (4)
Identification	
	(b) (4)
Printer & User Notes	
PRINTER TO REPLACE ALL FPO CODES WITH SCANNABLE ART. PRINTER RESPONSIBLE FOR ALL TRAPPING, BLEEDS, COATINGS AND RESOLUTION. PRINTER AND USERS RESPONSIBLE FOR PROPER LICENSING OF ALL FONTS USED IN THIS ARTWORK.	

DRUG FACTS TEXT DEFINED	TYPE SIZE
• HEADINGS	6 pt
• SUBHEADINGS/BODY TEXT	6 pt
• LEADING	6.5 pt
• BULLETS	5 pt
• SPACE BEFORE BULLET	2 ems
• WARNING BOX LINES	.5 pt

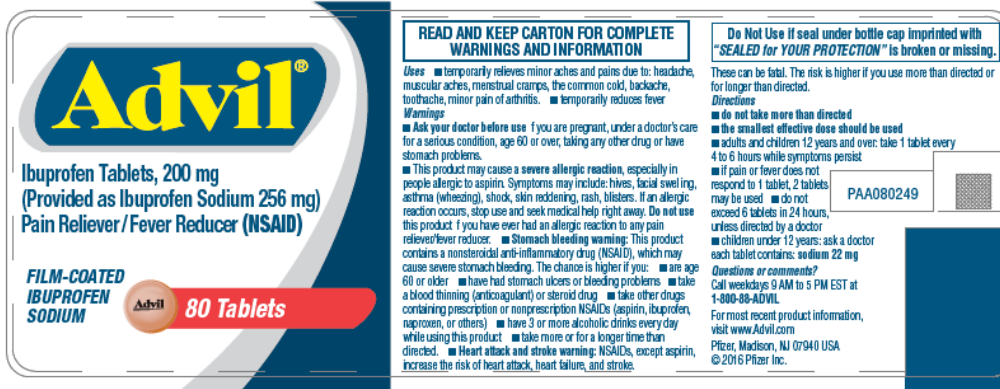

3/16" X 3/16" DATA MATRIX CODE (ECC200),
 PRINTED IN BLACK OR DARK BLUE ON
 UNPRINTED WHITE BACKGROUND.
DATA MATRIX CODE = 080249

UNVARNISHED AND PRINTED
 IN BLACK OR DARK BLUE.
 FOR LOT & EXPIRATION AREA.

090177e189be98da\Final\Final On: 29-Sep-2016 20:01

PRODUCTION

(NOT COLOR ACCURATE)

Job Information	Color Legend
Date 16-SEP-2016 PASS # 1 Component # PAA080249 Drawing # (b) (4)-00000433 v01	(b) (4)
Identification	
	(b) (4)
Printer & User Notes	
	PRINTER TO REPLACE ALL FPO CODES WITH SCANNABLE ART. PRINTER RESPONSIBLE FOR ALL TRAPPING, BLEEDS, COATINGS AND RESOLUTION. PRINTER AND USERS RESPONSIBLE FOR PROPER LICENSING OF ALL FONTS USED IN THIS ARTWORK.

DRUG FACTS TEXT DEFINED	TYPE SIZE
• HEADINGS	5 pt
• SUBHEADINGS/BODY TEXT	5 pt
• LEADING	5.5 pt
• BULLETS	4 pt
• SPACE BEFORE BULLET	2 ems
• WARNING BOX LINES	.5 pt, .8 pt

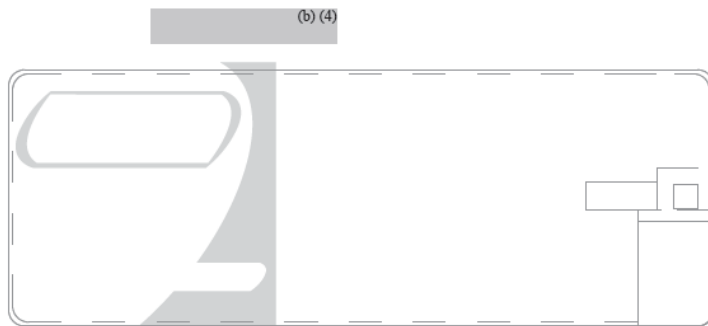

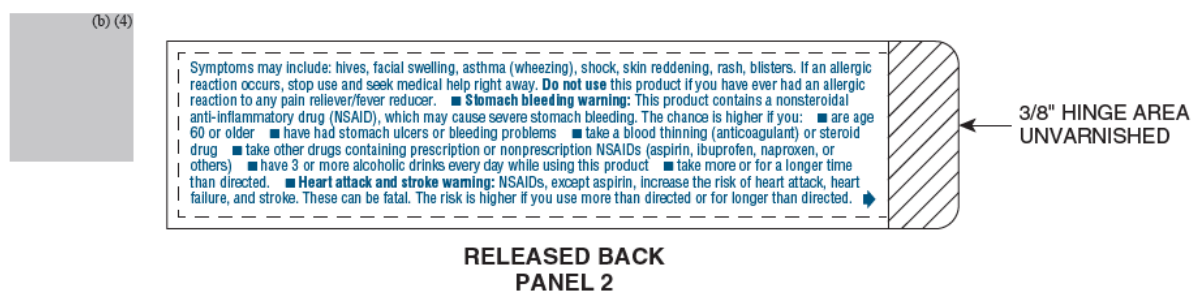
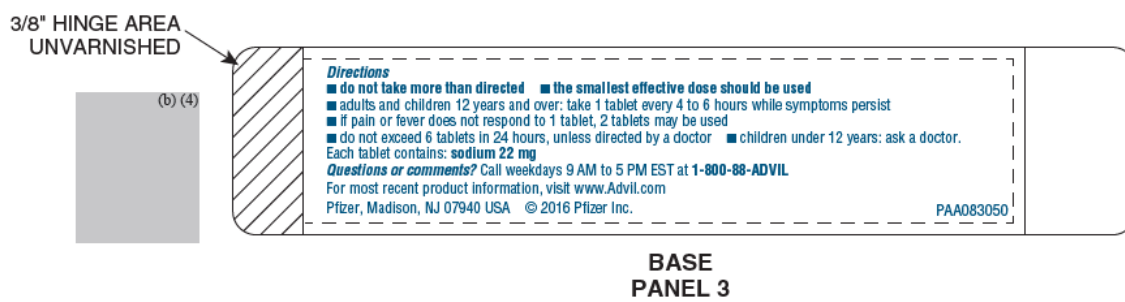
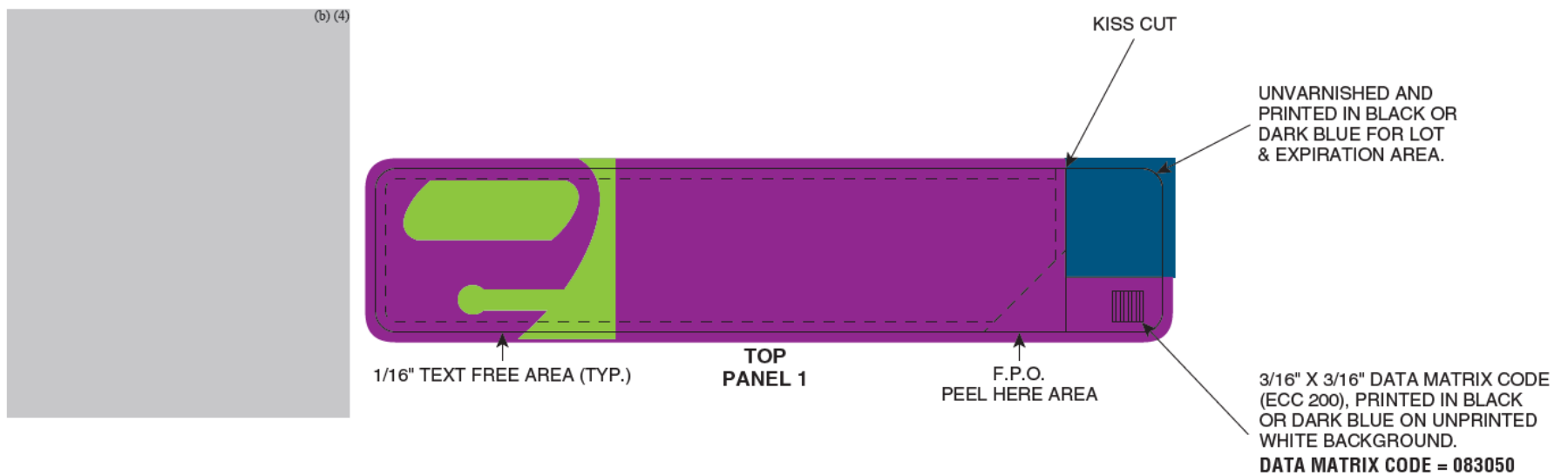

PRODUCTION

(NOT COLOR ACCURATE)

Job Information	Color Legend
Date 19-DEC-2016 PASS # 1 Component # PAA083050 Drawing # (b) (4)-00000785 v02	See Art For Colors.
Identification 	
Printer & User Notes PRINTER TO REPLACE ALL FPO CODES WITH SCANNABLE ART. PRINTER RESPONSIBLE FOR ALL TRAPPING, BLEEDS, COATINGS AND RESOLUTION. PRINTER AND USERS RESPONSIBLE FOR PROPER LICENSING OF ALL FONTS USED IN THIS ARTWORK.	

DRUG FACTS TEXT DEFINED	TYPE SIZE
• HEADINGS	6 pt
• SUBHEADINGS/BODY TEXT	6 pt
• LEADING	6.25 pt
• BULLETS	5 pt
• SPACE BEFORE BULLET	2 ems
• WARNING BOX LINE, HAIRLINES	.5 pt

090177e18b0bfb82\Final\Final On: 14-Jan-2017 06:10

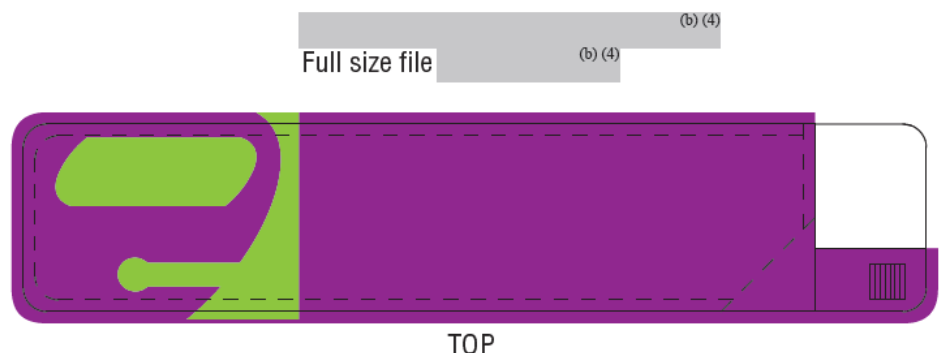
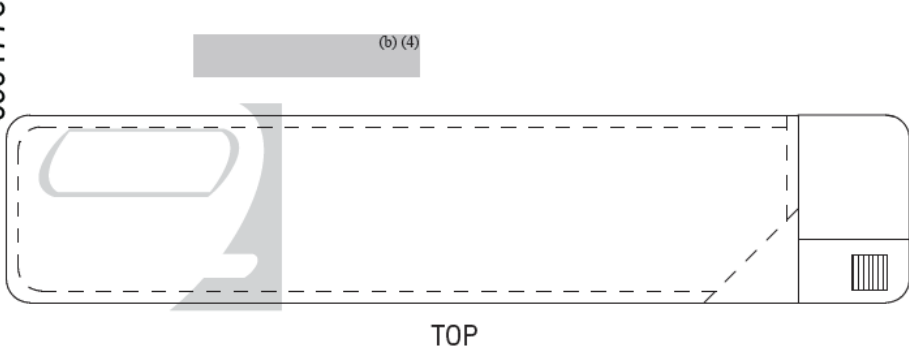

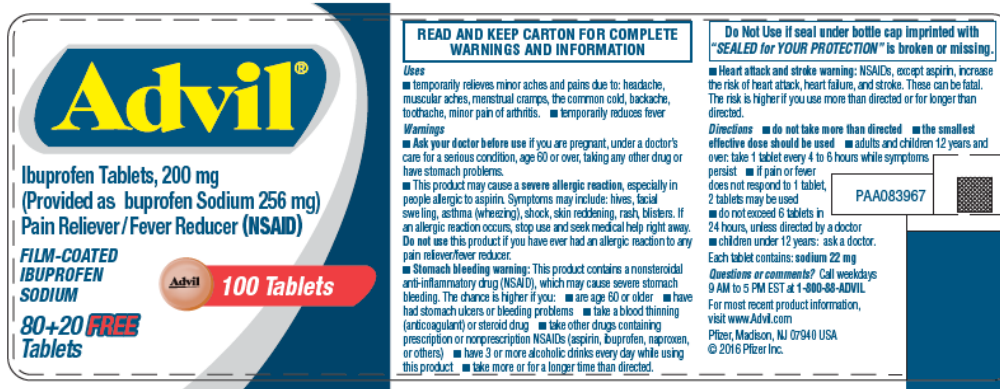

3/16" X 3/16" DATA MATRIX CODE (ECC 200),
 PRINTED IN BLACK OR DARK BLUE ON
 UNPRINTED WHITE BACKGROUND.
 DATA MATRIX CODE = 083967

UNVARNISHED AND PRINTED IN
 BLACK OR DARK BLUE FOR LOT &
 EXPIRATION AREA.

090177e18b0c197d\Final\Final On: 14-Jan-2017 05:46

PRODUCTION

(NOT COLOR ACCURATE)

Job Information	Color Legend
Date 04-JAN-2017 PASS # 1 Component # PAA083967 Drawing # (b) (4) -00000433v02	(b) (4)
Identification	
(b) (4)	
Printer & User Notes	
PRINTER TO REPLACE ALL FPO CODES WITH SCANNABLE ART. PRINTER RESPONSIBLE FOR ALL TRAPPING, BLEEDS, COATINGS AND RESOLUTION. PRINTER AND USERS RESPONSIBLE FOR PROPER LICENSING OF ALL FONTS USED IN THIS ARTWORK.	

DRUG FACTS TEXT DEFINED	TYPE SIZE
• HEADINGS	5 pt
• SUBHEADINGS/BODY TEXT	5 pt
• LEADING	5.5 pt
• BULLETS	4 pt
• SPACE BEFORE BULLET	2 ems
• WARNING BOX LINES	.5 pt, .8 pt

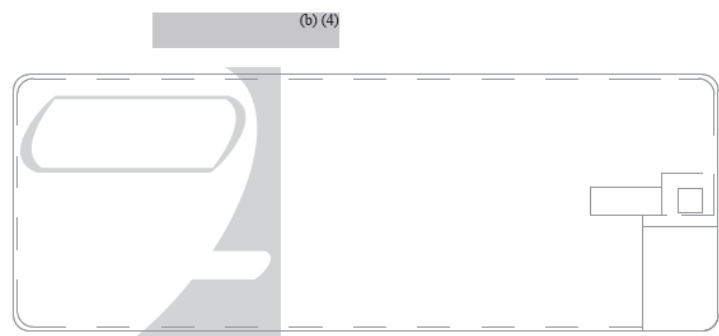



3/16" X 3/16" DATA MATRIX CODE (ECC200),
 PRINTED IN BLACK OR DARK BLUE ON
 UNPRINTED WHITE BACKGROUND.
DATA MATRIX CODE = 083969

UNVARNISHED AND PRINTED
 IN BLACK OR DARK BLUE FOR
 LOT & EXPIRATION AREA.

PRODUCTION

(NOT COLOR ACCURATE)

Job Information	Color Legend
Date 05-JAN-2017 PASS # 1 Component # PAA083969 Drawing # (b) (4)-00000507 v02	(b) (4)
Identification	
	Printer & User Notes PRINTER TO REPLACE ALL FPO CODES WITH SCANNABLE ART. PRINTER RESPONSIBLE FOR ALL TRAPPING, BLEEDS, COATINGS AND RESOLUTION. PRINTER AND USERS RESPONSIBLE FOR PROPER LICENSING OF ALL FONTS USED IN THIS ARTWORK.
(b) (4)	

DRUG FACTS TEXT DEFINED	TYPE SIZE
• HEADINGS	5.5 pt
• SUBHEADINGS/BODY TEXT	5.5 pt
• LEADING	6 pt
• BULLETS	4.5 pt
• SPACE BEFORE BULLET	2 ems
• WARNING BOX LINES	.5 pt

090177e18b0c19c4\Final\Final On: 14-Jan-2017 05:50

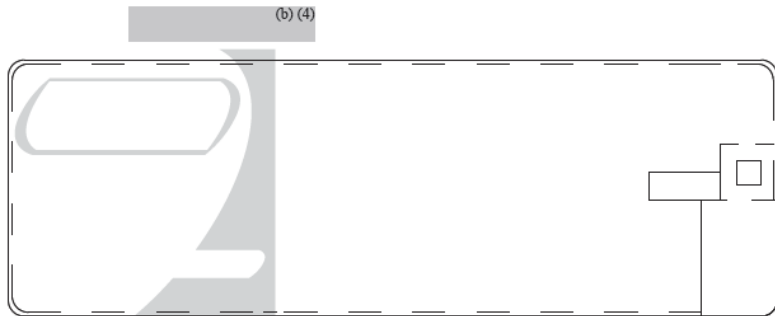

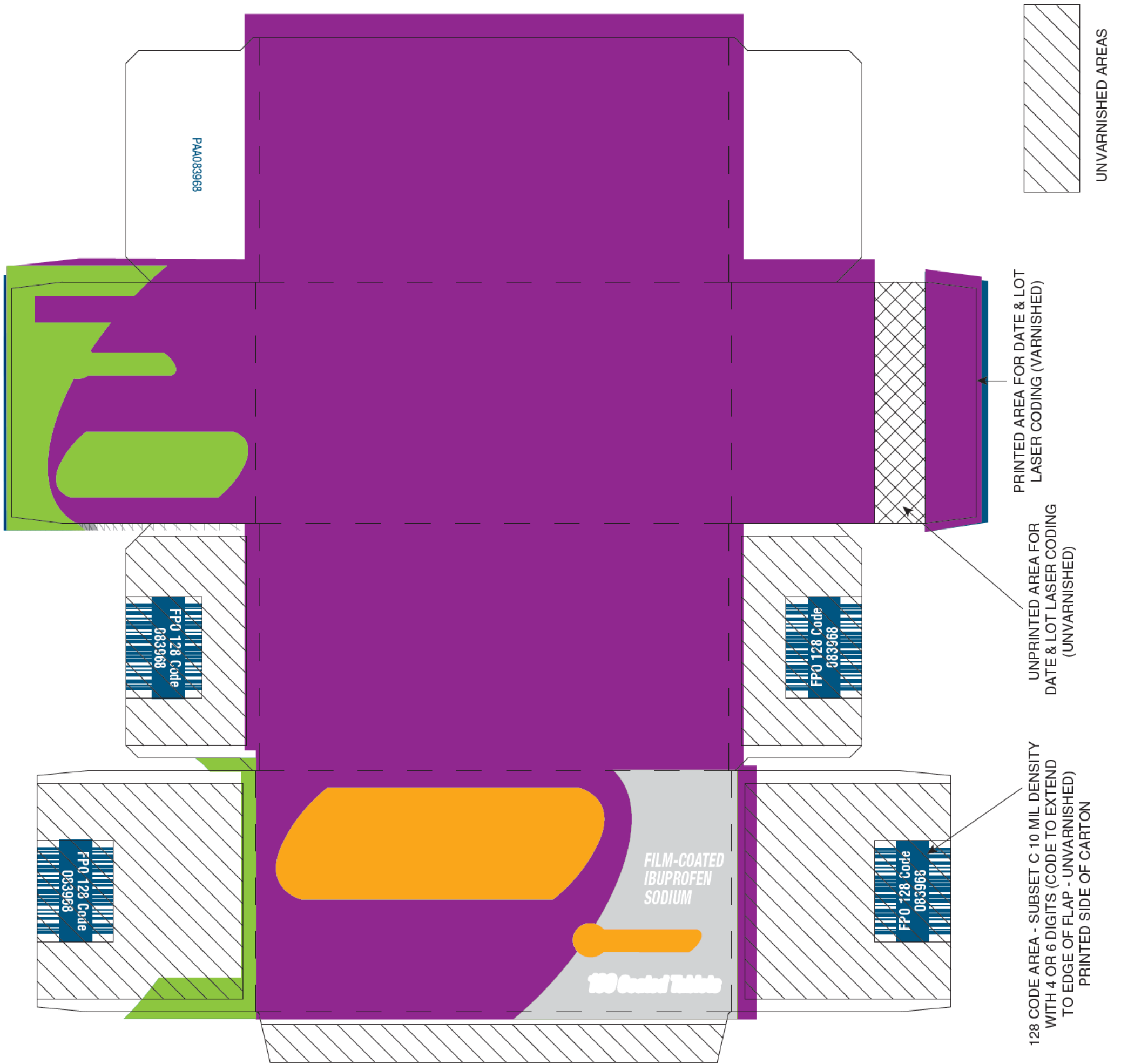

PRODUCTION

(NOT COLOR ACCURATE)

Job Information	Color Legend
Date 05-JAN-2017 PASS # 1 Component # PAA083968 Drawing # (b) (4)-00000500 v02	(b) (4)
Identification	
Printer & User Notes	
PRINTER TO REPLACE ALL FPO CODES WITH SCANNABLE ART. PRINTER RESPONSIBLE FOR ALL TRAPPING, BLEEDS, COATINGS AND RESOLUTION. PRINTER AND USERS RESPONSIBLE FOR PROPER LICENSING OF ALL FONTS USED IN THIS ARTWORK.	

DRUG FACTS TEXT DEFINED	TYPE SIZE
• DRUG FACTS TITLE	9 pt
• DRUG FACTS CONTINUED	8 pt
• HEADINGS	8 pt
• SUBHEADINGS/BODY TEXT	6 pt
• LEADING	6.75 pt
• # OF CHARACTERS PER INCH	<39
• BULLETS	5 pt
• SPACE BEFORE BULLET	N/A
• BARLINES, HAIRLINES	1.5 pt, .5 pt
• SPACE BETWEEN HAIRLINES AND BOX END	2 spaces

090177e18b0c19c5\Final\On: 14-Jan-2017 05:50

(b) (4)
Full size file (b) (4)

(b) (4)
Full size file (b) (4)

(b) (4)
Full size file (b) (4)

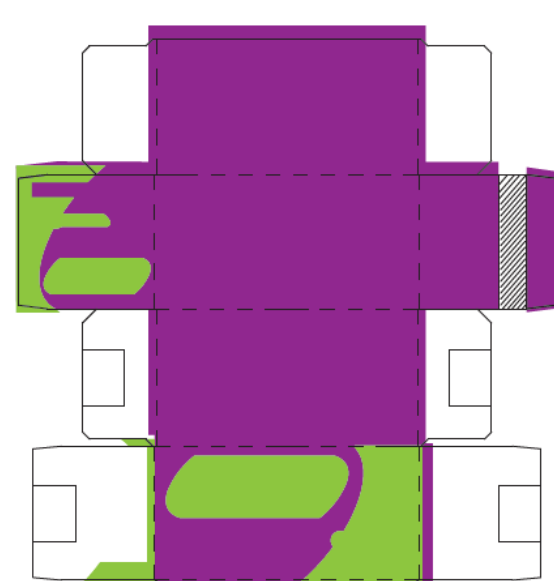
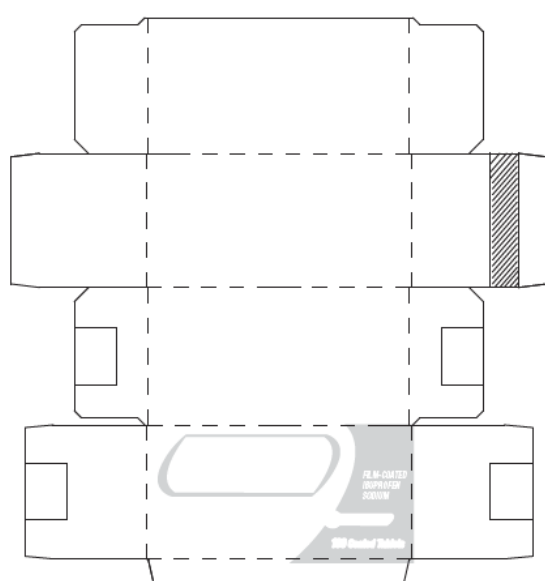
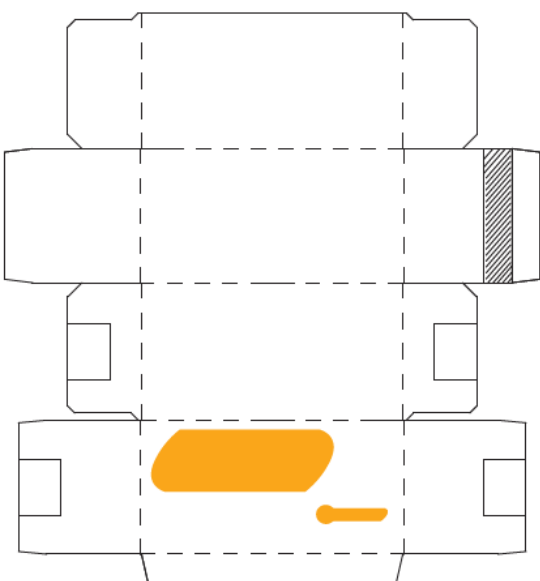

Pfizer Consumer Healthcare

Advil Film Coated Tablets 40ct Save \$1.00 IRC D000056545

090177e18b0c1976\Final\Final On: 14-Jan-2017 06:10

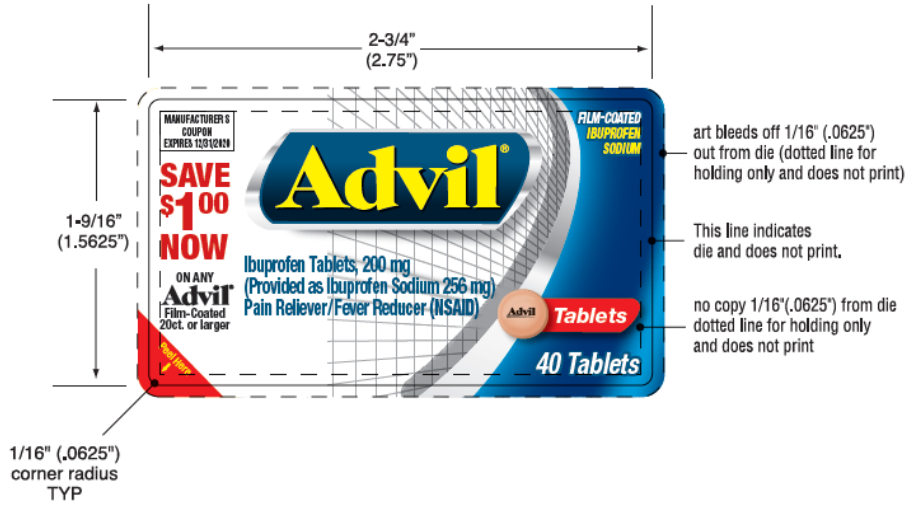

090177e18b0c197c\Final\Final On: 14-Jan-2017 06:12



Encode: 8110003057302887831001103113171231

PRODUCTION

(NOT COLOR ACCURATE)

Job Information	Color Legend
Date 10-FEB-2015 PASS # 1 Component # D000050399 Drawing # Vendor (b) (4)	(b) (4)
Identification	
(b) (4)	Printer & User Notes
	PRINTER TO REPLACE ALL FPO CODES WITH SCANNABLE ART. PRINTER RESPONSIBLE FOR ALL TRAPPING, VARNISH AND BLEEDS. PRINTER AND USERS RESPONSIBLE FOR PROPER LICENSING OF ALL FONTS USED IN THIS ARTWORK.

NOTE: ART CONTAINS A *LIVE* DIGICODE. PRINTER RESPONSIBLE FOR ACCURATE REPRODUCTION.

090177e18bb39563\Final\Final On: 12-Apr-2017 05:50 (GMT)



Encode: 8110003057303212732001103113201231

PRODUCTION (NOT COLOR ACCURATE)

Job Information	Color Legend
Date 13-JAN-2017 PASS # 1 Component # D000056707 Drawing # Vendor (b) (4)	(b) (4)
Identification (b) (4)	
Printer & User Notes PRINTER TO REPLACE ALL FPO CODES WITH SCANNABLE ART. PRINTER RESPONSIBLE FOR ALL TRAPPING, BLEEDS, COATINGS AND RESOLUTION. PRINTER AND USERS RESPONSIBLE FOR PROPER LICENSING OF ALL FONTS USED IN THIS ARTWORK.	

NOTE: ART CONTAINS A LIVE DIGICODE. PRINTER RESPONSIBLE FOR ACCURATE REPRODUCTION.



Encode: 8110003057303212732001103113201231

PRODUCTION (NOT COLOR ACCURATE)

Job Information	Color Legend
Date 18-JAN-2017 PASS # 1 Component # D000056708 Drawing # Vendor (b) (4)	(b) (4)
Identification	
Pfizer Consumer Healthcare	(b) (4)
Printer & User Notes	
PRINTER TO REPLACE ALL FPO CODES WITH SCANNABLE ART. PRINTER RESPONSIBLE FOR ALL TRAPPING, BLEEDS, COATINGS AND RESOLUTION. PRINTER AND USERS RESPONSIBLE FOR PROPER LICENSING OF ALL FONTS USED IN THIS ARTWORK.	

NOTE: ART CONTAINS A LIVE DIGICODE. PRINTER RESPONSIBLE FOR ACCURATE REPRODUCTION.

128 CODE AREA SUBSET C 10 MIL DENSITY
WITH 4, 6 OR 8 DIGITS
(UNVARNISHED)
128 CODE = 080941

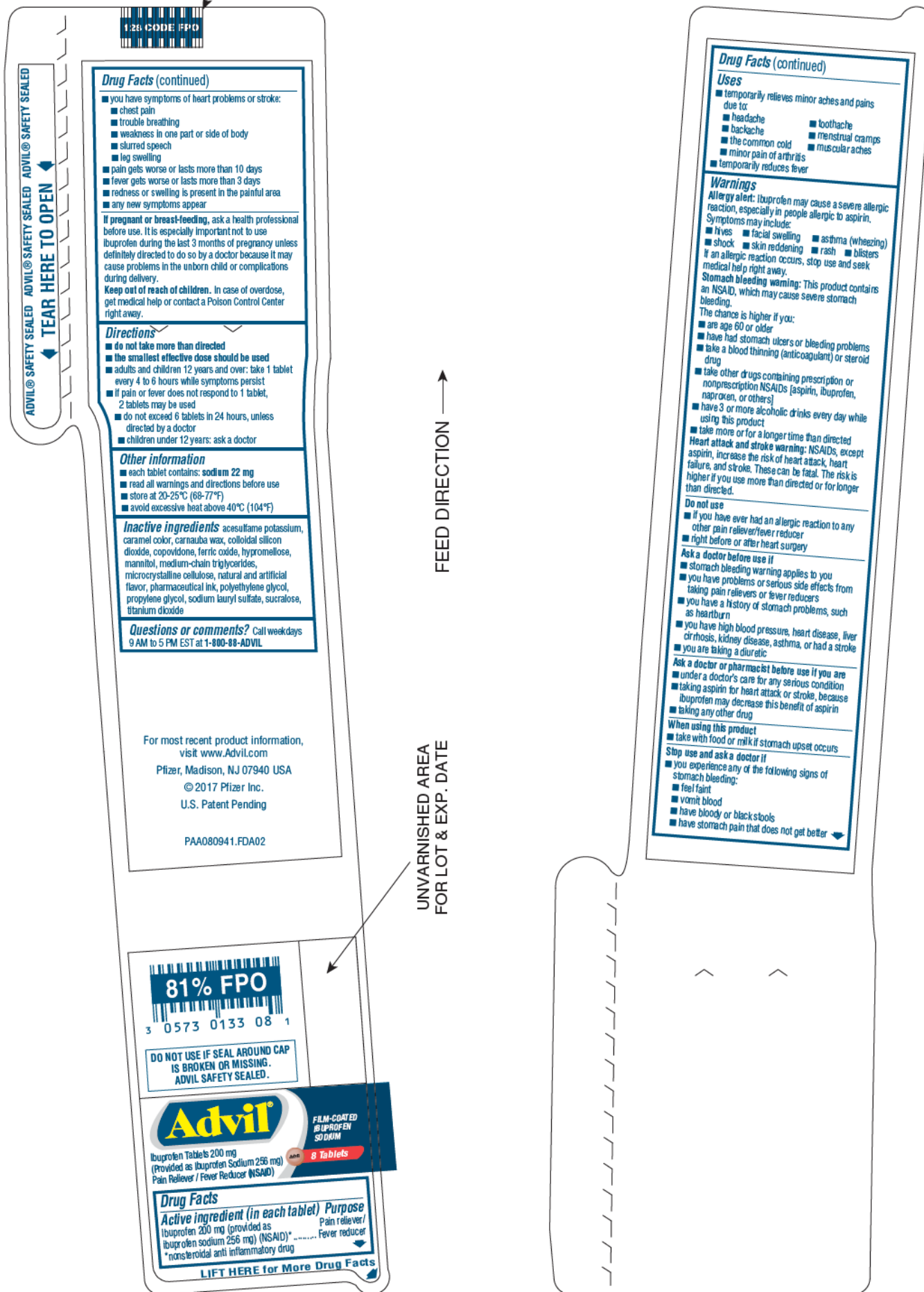

PRODUCTION

(NOT COLOR ACCURATE)

Job Information	Color Legend
Date 02-MAY-2017 PASS # 1 Component # PAA080941.FDA02 Drawing # (b) (4)-50031051v02	(b) (4)
Identification	Printer & User Notes
	PRINTER TO REPLACE ALL FPO CODES WITH SCANNABLE ART. PRINTER RESPONSIBLE FOR ALL TRAPPING, BLEEDS, COATINGS AND RESOLUTION. PRINTER AND USERS RESPONSIBLE FOR PROPER LICENSING OF ALL FONTS USED IN THIS ARTWORK.

DRUG FACTS TEXT DEFINED	TYPE SIZE
• DRUG FACTS TITLE	9 pt
• DRUG FACTS CONTINUED	8 pt
• HEADINGS	8 pt
• SUBHEADINGS/BODY TEXT	6 pt
• LEADING	6.5 pt
• # OF CHARACTERS PER INCH	<39
• BULLETS	5 pt
• SPACE BEFORE BULLET	2 ems
• BARLINES, HAIRLINES	1.5 pt, .5 pt
• SPACE BETWEEN HAIRLINES AND BOX END	2 spaces

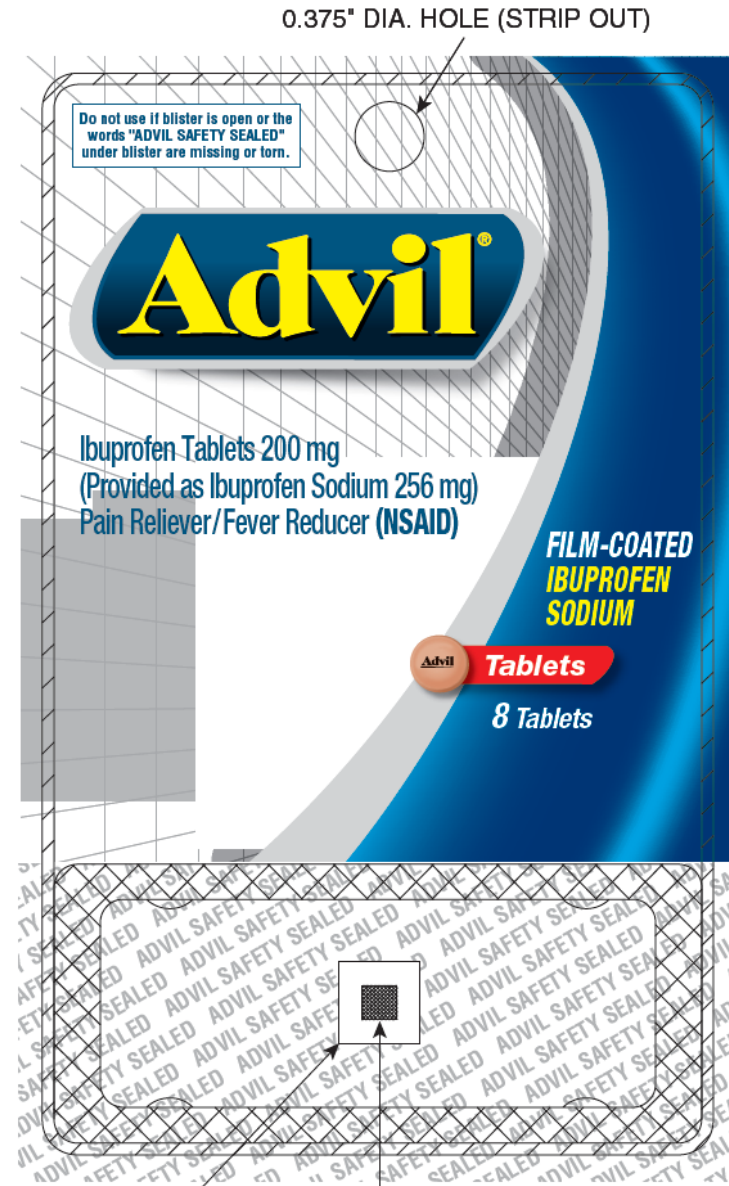

1/8" CLEAR AREA AROUND DATA MATRIX - UNPRINTED

0.187" DATA MATRIX CODE (ECC 200), PRINTED IN BLACK OR BLUE ON UNPRINTED WHITE BACKGROUND
DATA MATRIX CODE = 080942

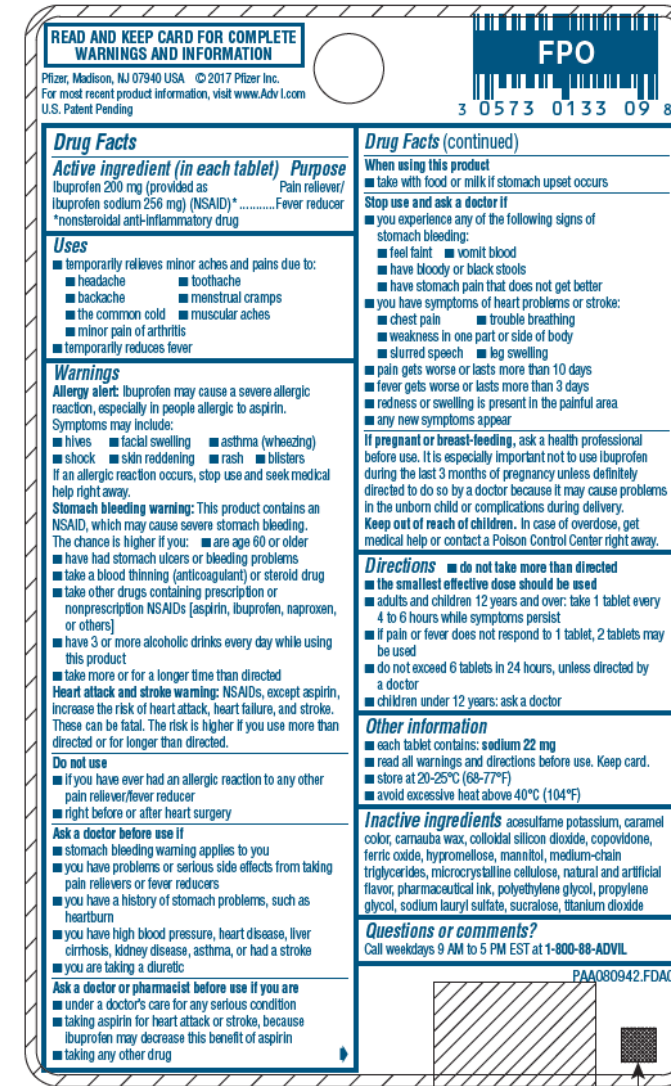

LOT & EXP AREA

0.187" DATA MATRIX CODE (ECC 200), PRINTED IN BLACK OR BLUE ON UNPRINTED WHITE BACKGROUND
DATA MATRIX CODE = 080942

PRODUCTION

(NOT COLOR ACCURATE)

Job Information	Color Legend
Date 03-MAY-2017 PASS # 1 Component # PAA080942.FDA02 Drawing # (b) (4)-50036033v01	(b) (4)
Identification	
Printer & User Notes	
PRINTER TO REPLACE ALL FPO CODES WITH SCANNABLE ART. PRINTER RESPONSIBLE FOR ALL TRAPPING, BLEEDS, COATINGS AND RESOLUTION. PRINTER AND USERS RESPONSIBLE FOR PROPER LICENSING OF ALL FONTS USED IN THIS ARTWORK.	

DRUG FACTS TEXT DEFINED	TYPE SIZE
• DRUG FACTS TITLE	9 pt
• DRUG FACTS CONTINUED	8 pt
• HEADINGS	8 pt
• SUBHEADINGS/BODY TEXT	6 pt
• LEADING	6.5 pt
• # OF CHARACTERS PER INCH	<39
• BULLETS	5 pt
• SPACE BEFORE BULLET	2 ems
• BARLINES, HAIRLINES	1.5 pt, .5 pt
• SPACE BETWEEN HAIRLINES AND BOX END	2 spaces

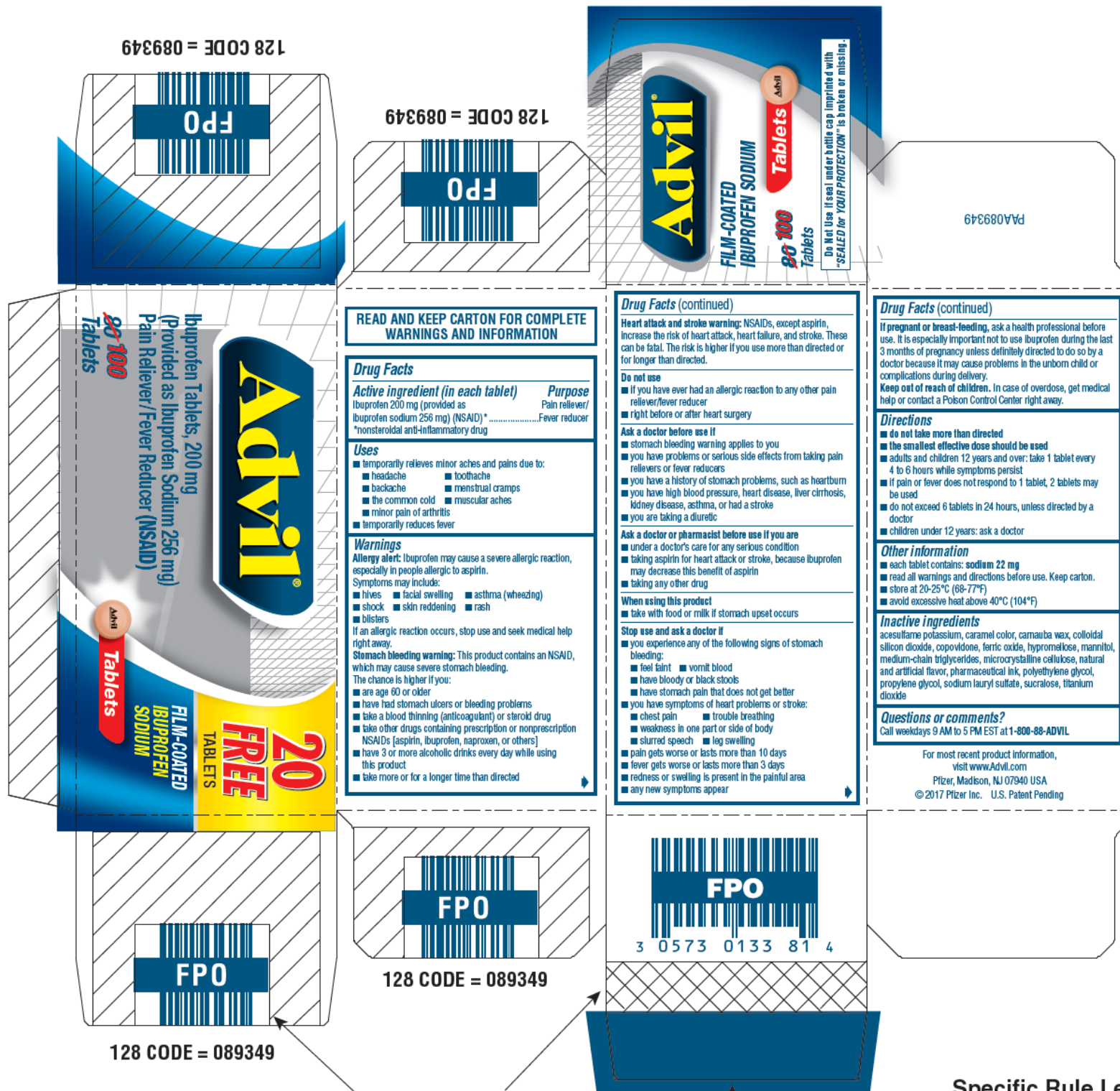

128 CODE AREA - SUBSET C 10 MIL DENSITY WITH 4 OR 6 DIGITS (CODE TO EXTEND TO EDGE OF FLAP - UNVARNISHED) PRINTED SIDE OF CARTON

UNPRINTED AREA FOR DATE & LOT (UNVARNISHED)

PRINTED AREA FOR DATE & LOT LASER CODING (VARNISHED)

Specific Rule Legend

Cut _____
Crease - - - - -

UNVARNISHED AREAS

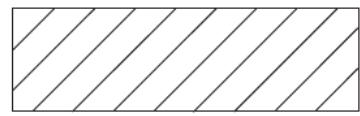

PRODUCTION

(NOT COLOR ACCURATE)

Job Information	Color Legend
Date 08-MAY-2017 PASS # 2 Component # PAA089349 Drawing # (b) (4)-00000432v04	(b) (4)
Identification	Printer & User Notes
	PRINTER TO REPLACE ALL FPO CODES WITH SCANNABLE ART. PRINTER RESPONSIBLE FOR ALL TRAPPING, BLEEDS, COATINGS AND RESOLUTION. PRINTER AND USERS RESPONSIBLE FOR PROPER LICENSING OF ALL FONTS USED IN THIS ARTWORK.

DRUG FACTS TEXT DEFINED	TYPE SIZE
• DRUG FACTS TITLE	9 pt
• DRUG FACTS CONTINUED	8 pt
• HEADINGS	8 pt
• SUBHEADINGS/BODY TEXT	6 pt
• LEADING	6.5 pt
• # OF CHARACTERS PER INCH	<39
• BULLETS	5 pt
• SPACE BEFORE BULLET	2 ems
• BARLINES, HAIRLINES	1.5 pt, .5 pt
• SPACE BETWEEN HAIRLINES AND BOX END	2 spaces

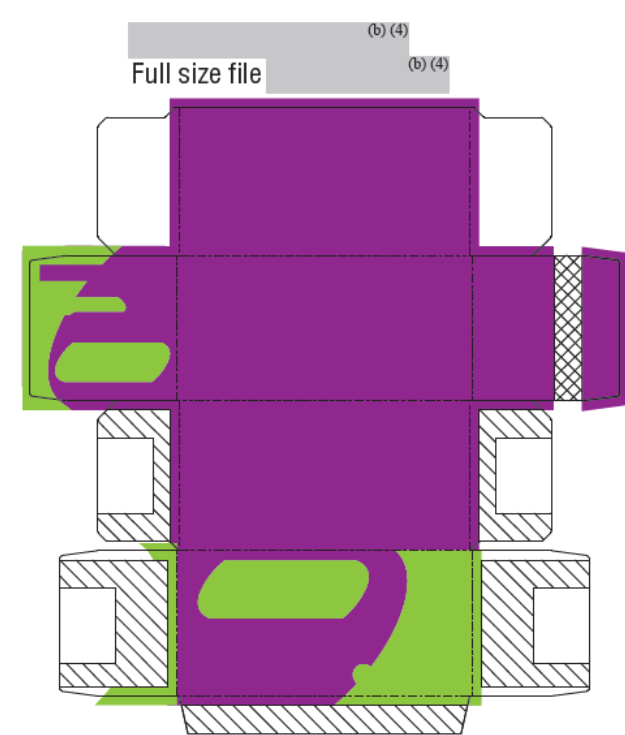
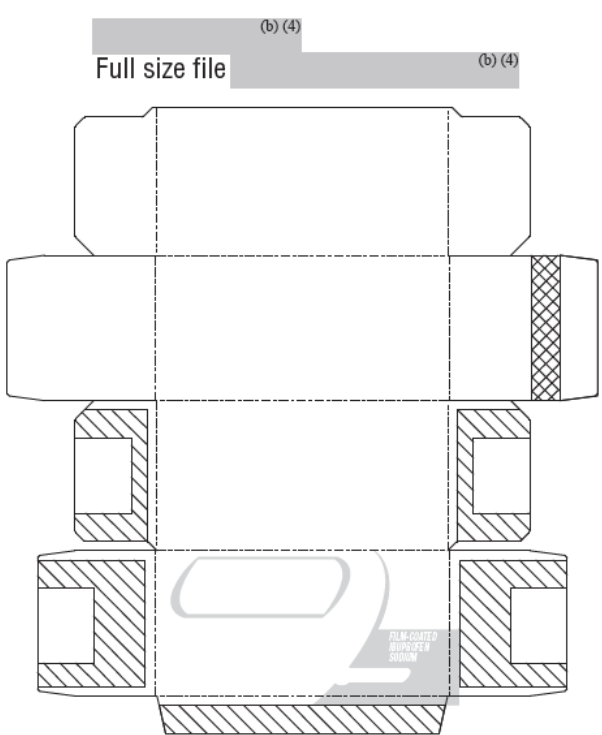
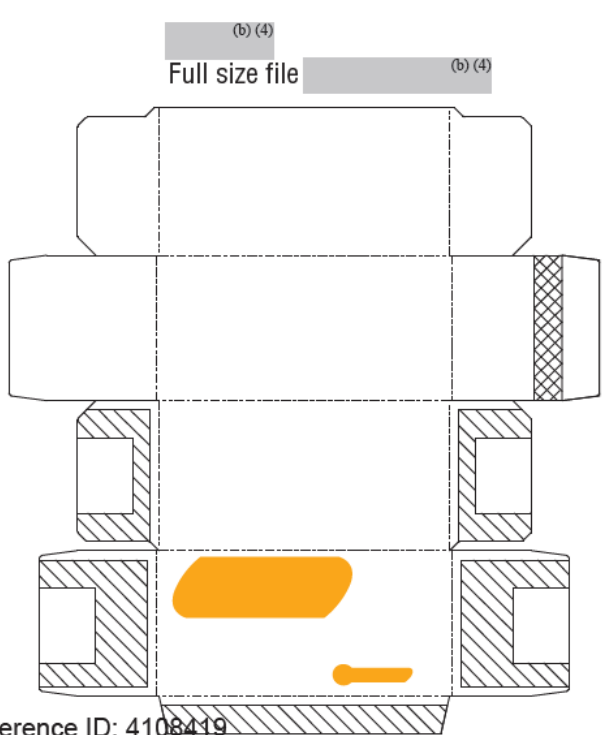



3/16" X 3/16" DATA MATRIX CODE (ECC 200),
 PRINTED IN BLACK OR DARK BLUE
 ON UNPRINTED WHITE BACKGROUND.
DATA MATRIX CODE = 080438

UNVARNISHED AND PRINTED
 IN BLACK OR DARK BLUE.
 FOR LOT & EXPIRATION AREA

PRODUCTION

(NOT COLOR ACCURATE)

Job Information	Color Legend
Date 19-SEP-2016 PASS # 1 Component # PAA080438.FDA01 Drawing # (b) (4)-00000433	(b) (4)
Identification	
	(b) (4)
Printer & User Notes	
PRINTER TO REPLACE ALL FPO CODES WITH SCANNABLE ART. PRINTER RESPONSIBLE FOR ALL TRAPPING, BLEEDS, COATINGS AND RESOLUTION. PRINTER AND USERS RESPONSIBLE FOR PROPER LICENSING OF ALL FONTS USED IN THIS ARTWORK.	

DRUG FACTS TEXT DEFINED	TYPE SIZE
• HEADINGS	5.5 pt
• SUBHEADINGS/BODY TEXT	5.5 pt
• LEADING	6 pt
• BULLETS	4.5 pt
• SPACE BEFORE BULLET	2 ems
• WARNING BOX LINES	.5 pt

090177e189bea68c\Final\Final On: 29-Sep-2016 20:27

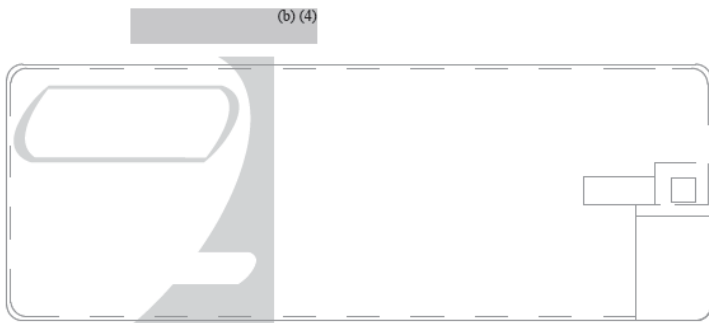

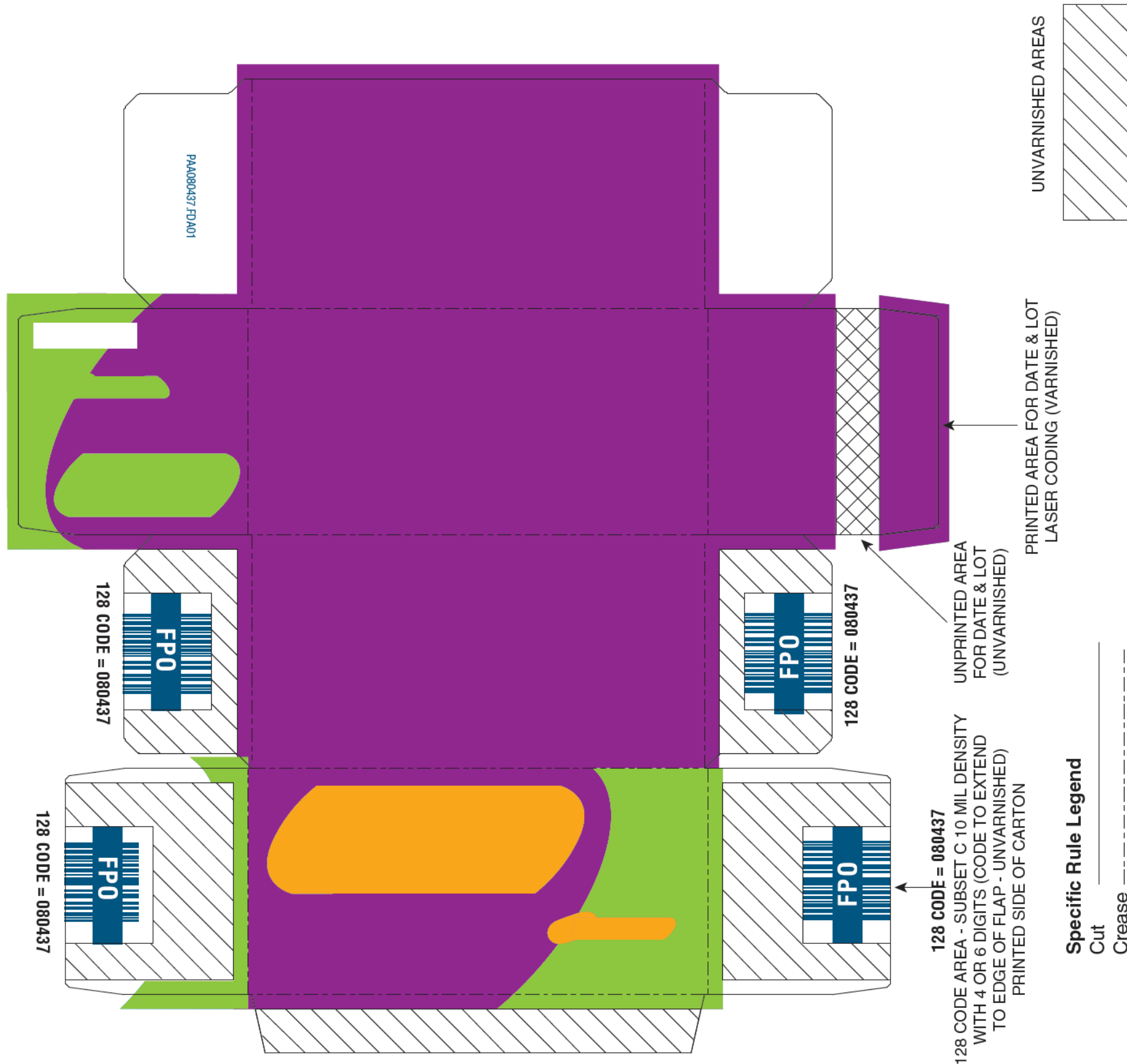

PRODUCTION

(NOT COLOR ACCURATE)

Job Information	Color Legend
Date 19-SEP-2016 PASS # 1 Component # PAA080437.FDA01 Drawing # (b) (4) -00000432v04	(b) (4)
Identification	
	(b) (4)
Printer & User Notes	
PRINTER TO REPLACE ALL FPO CODES WITH SCANNABLE ART. PRINTER RESPONSIBLE FOR ALL TRAPPING, BLEEDS, COATINGS AND RESOLUTION. PRINTER AND USERS RESPONSIBLE FOR PROPER LICENSING OF ALL FONTS USED IN THIS ARTWORK.	

DRUG FACTS TEXT DEFINED	TYPE SIZE
• DRUG FACTS TITLE	9 pt
• DRUG FACTS CONTINUED	8 pt
• HEADINGS	8 pt
• SUBHEADINGS/BODY TEXT	6 pt
• LEADING	6.5 pt
• # OF CHARACTERS PER INCH	<39
• BULLETS	5 pt
• SPACE BEFORE BULLET	2 ems
• BARLINES, HAIRLINES	1.5 pt, .5 pt
• SPACE BETWEEN HAIRLINES AND BOX END	2 spaces

090177e189be98dd\Final\Final On: 29-Sep-2016 20:07

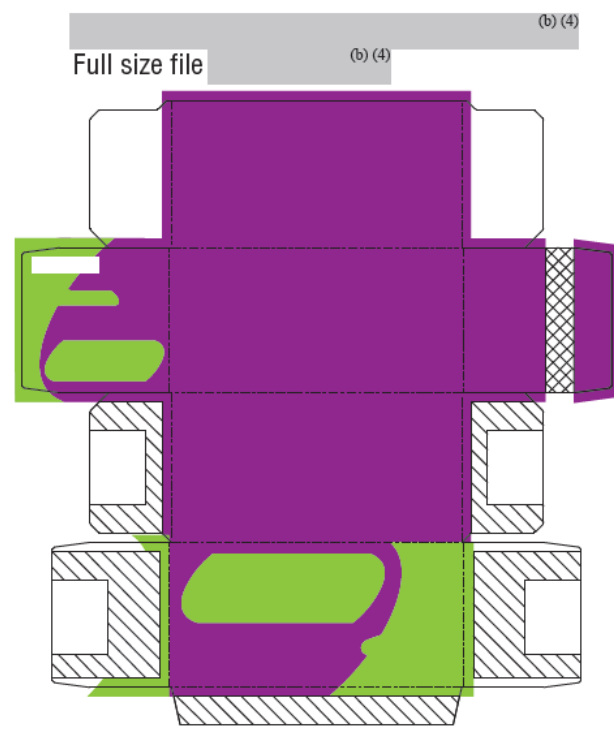
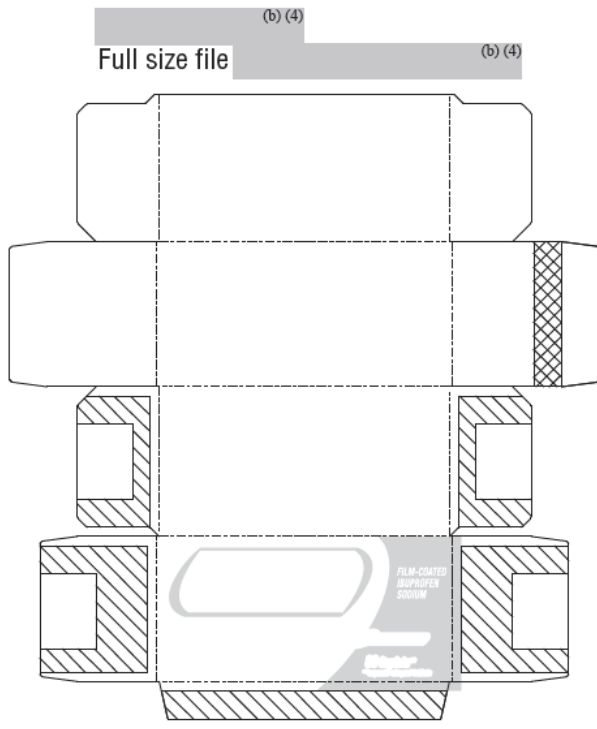
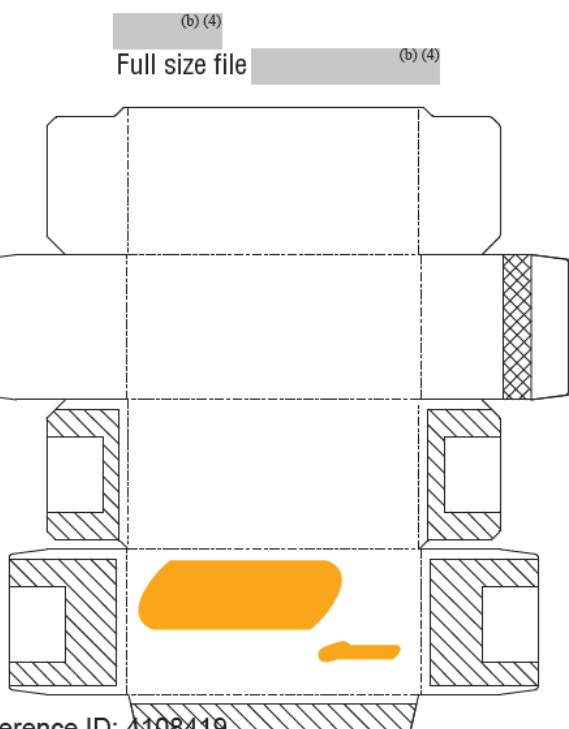

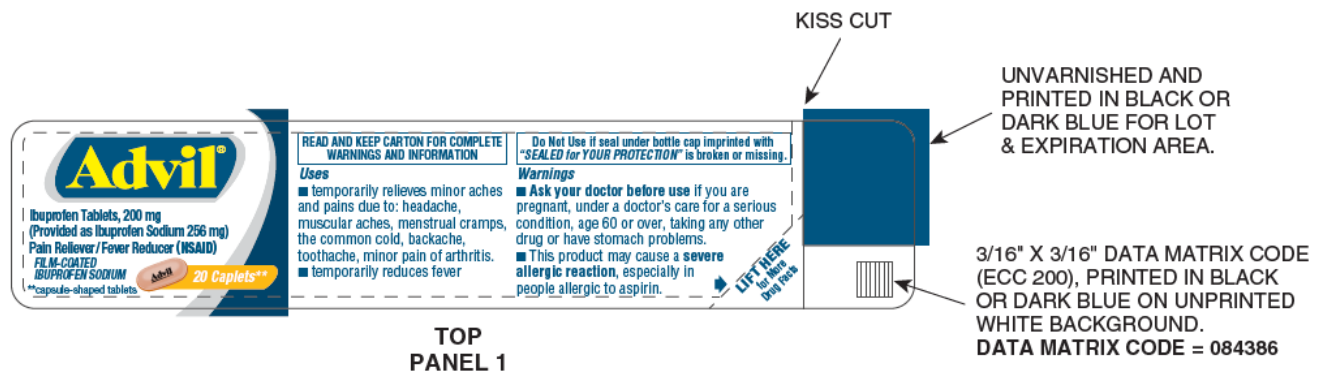
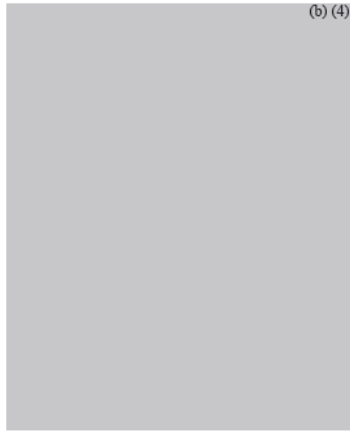

TOP
PANEL 1



3/8" HINGE AREA
UNVARNISHED

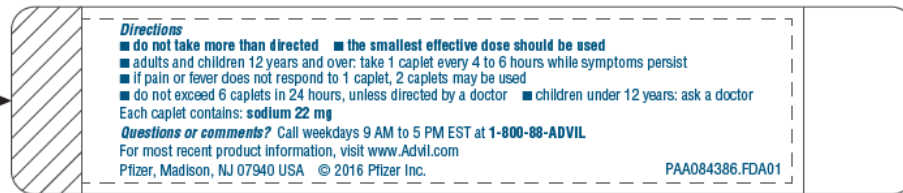

BASE
PANEL 3

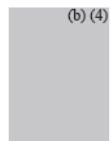

3/8" HINGE AREA
UNVARNISHED

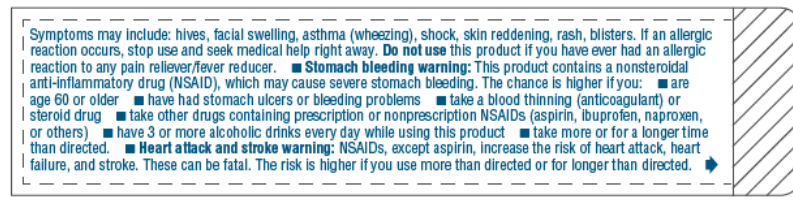

RELEASED BACK
PANEL 2

PRODUCTION

(NOT COLOR ACCURATE)

Job Information	Color Legend
Date 10-JAN-2017 PASS # 1 Component # PAA084386.FDA01 Drawing # (b) (4) -00000785v02	See Art For Colors
Identification 	
	Printer & User Notes PRINTER TO REPLACE ALL FPO CODES WITH SCANNABLE ART. PRINTER RESPONSIBLE FOR ALL TRAPPING, BLEEDS, COATINGS AND RESOLUTION. PRINTER AND USERS RESPONSIBLE FOR PROPER LICENSING OF ALL FONTS USED IN THIS ARTWORK.

DRUG FACTS TEXT DEFINED	TYPE SIZE
• HEADINGS	6 pt
• SUBHEADINGS/BODY TEXT	6 pt
• LEADING	6.25 pt
• BULLETS	5 pt
• SPACE BEFORE BULLET	2 ems
• WARNING BOX LINE, HAIRLINES	.5 pt

090177e18b0bfb7aFinalFinal On: 14-Jan-2017 06:06



Full size file

(b) (4)



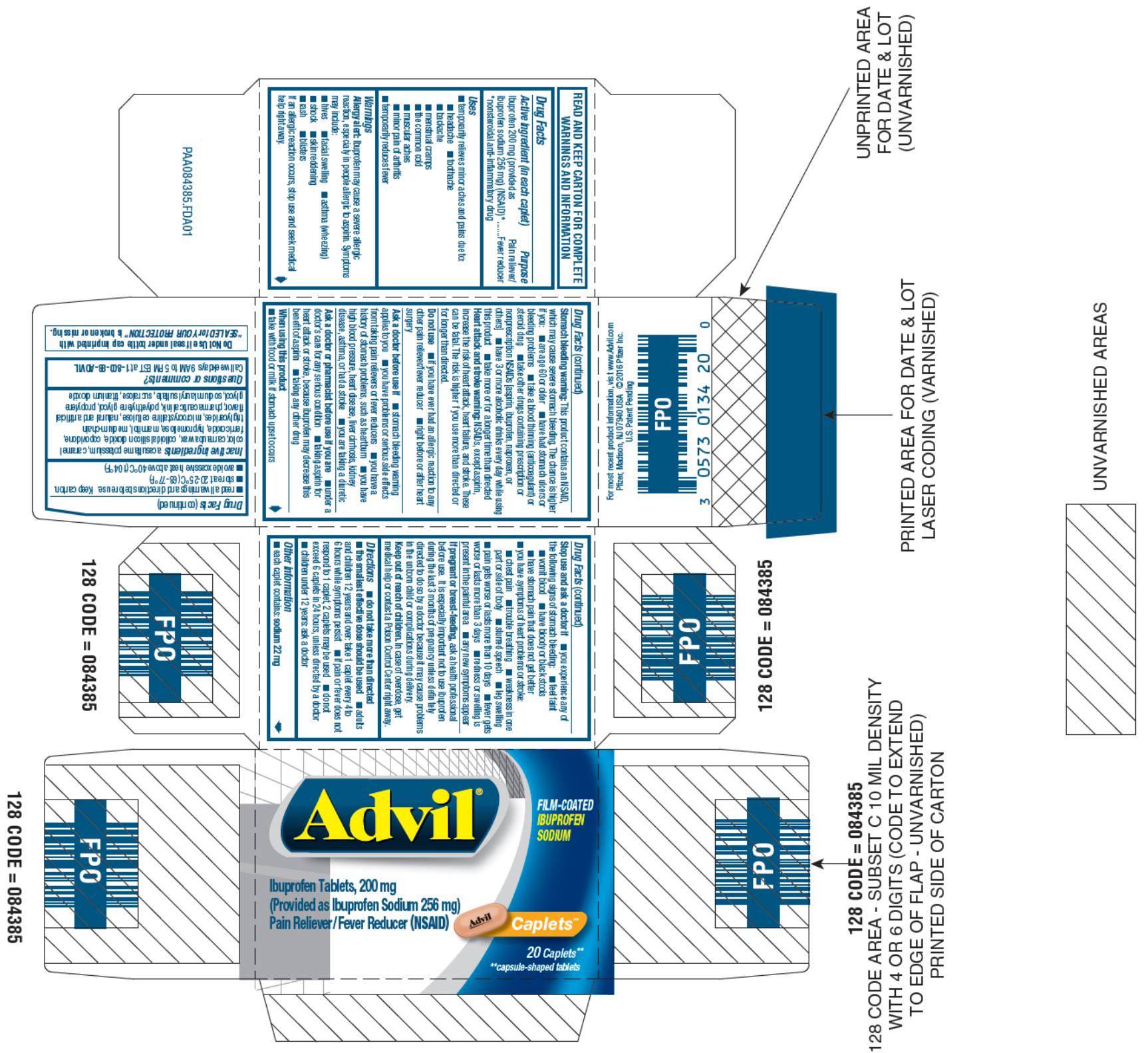

PRODUCTION

(NOT COLOR ACCURATE)

Job Information	Color Legend
<p>Date 13-JAN-2017 PASS # 2 Component # PAA084385.FDA01 Drawing # (b) (4)-00001042 v04</p>	<p>(b) (4)</p>
<p>Identification</p> <p> (b) (4)</p>	
<p>Printer & User Notes</p> <p>PRINTER TO REPLACE ALL FPO CODES WITH SCANNABLE ART.</p> <p>PRINTER RESPONSIBLE FOR ALL TRAPPING, BLEEDS, COATINGS AND RESOLUTION. PRINTER AND USERS RESPONSIBLE FOR PROPER LICENSING OF ALL FONTS USED IN THIS ARTWORK.</p>	

DRUG FACTS TEXT DEFINED	TYPE SIZE
• DRUG FACTS TITLE	8 pt
• DRUG FACTS CONTINUED	7 pt
• HEADINGS	7 pt
• SUBHEADINGS/BODY TEXT	6 pt
• LEADING	6.25 pt
• # OF CHARACTERS PER INCH	<39
• BULLETS	5 pt
• SPACE BEFORE BULLET	2 ems
• BARLINES, HAIRLINES	1.5 pt, .5 pt
• SPACE BETWEEN HAIRLINES AND BOX END	2 spaces

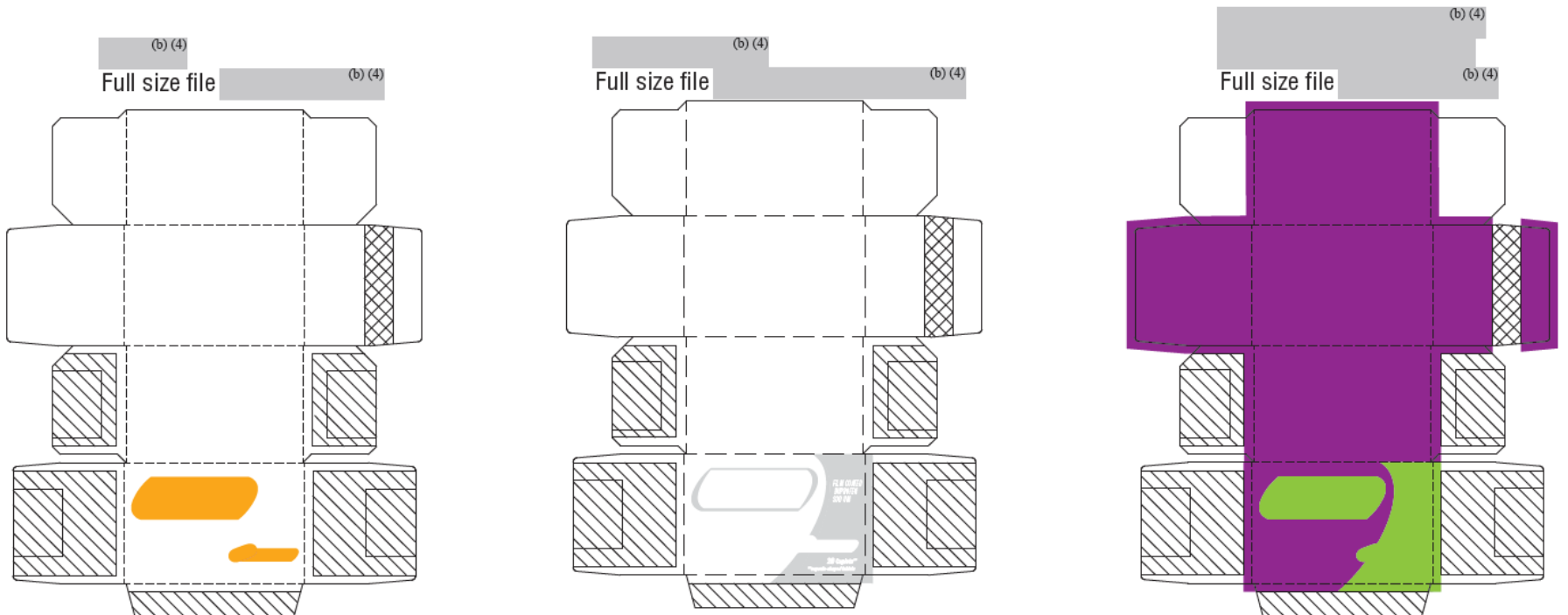

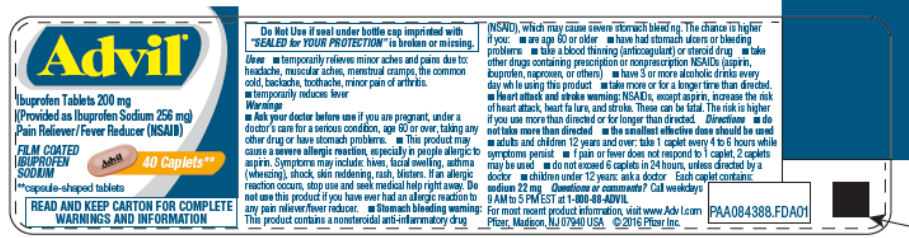

UNVARNISHED AND PRINTED IN BLACK OR DARK BLUE FOR LOT & EXPIRATION AREA.

3/16" X 3/16" DATA MATRIX CODE (ECC 200), PRINTED IN BLACK OR DARK BLUE ON UNPRINTED WHITE BACKGROUND. DATA MATRIX CODE = 084388

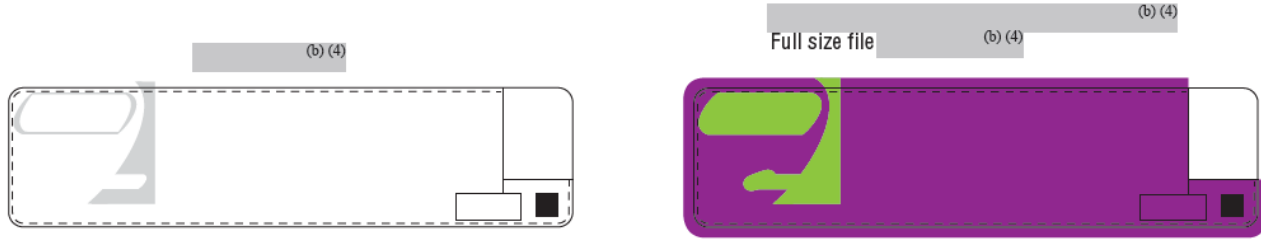

090177e18b0c1977\Final\Final On: 14-Jan-2017 06:10

PRODUCTION

(NOT COLOR ACCURATE)

Job Information	Color Legend
Date 11-JAN-2017 PASS # 1 Component # PAA084388.FDA01 Drawing # (b) (4)-00000435v02	(b) (4)
Identification	
	(b) (4)
Printer & User Notes	
PRINTER TO REPLACE ALL FPO CODES WITH SCANNABLE ART. PRINTER RESPONSIBLE FOR ALL TRAPPING, BLEEDS, COATINGS AND RESOLUTION. PRINTER AND USERS RESPONSIBLE FOR PROPER LICENSING OF ALL FONTS USED IN THIS ARTWORK.	

DRUG FACTS TEXT DEFINED	TYPE SIZE
• HEADINGS	4.5 pt
• SUBHEADINGS/BODY TEXT	4.5 pt
• LEADING	4.5 pt
• BULLETS	3.5 pt
• SPACE BEFORE BULLET	2 ems
• WARNING BOX LINES	.5 pt

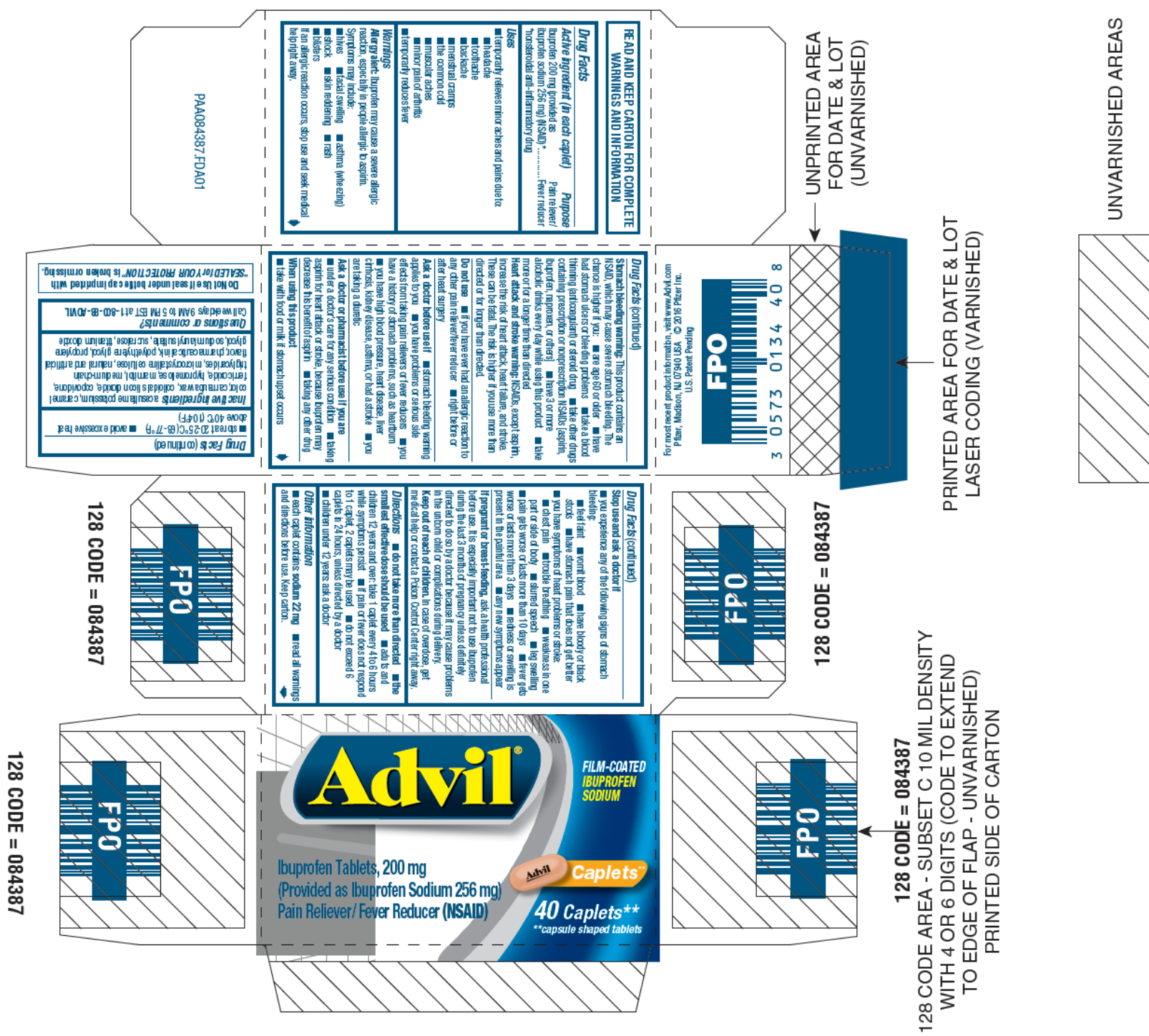

PRODUCTION

(NOT COLOR ACCURATE)

Job Information	Color Legend
<p>Date 12-JAN-2017 PASS # 1 Component # PAA084387.FDA01 Drawing # (b) (4)-00001119v04</p>	(b) (4)
Identification	
Printer & User Notes	
<p>PRINTER TO REPLACE ALL FPO CODES WITH SCANNABLE ART.</p> <p>PRINTER RESPONSIBLE FOR ALL TRAPPING, BLEEDS, COATINGS AND RESOLUTION.</p> <p>PRINTER AND USERS RESPONSIBLE FOR PROPER LICENSING OF ALL FONTS USED IN THIS ARTWORK.</p>	

DRUG FACTS TEXT DEFINED	TYPE SIZE
• DRUG FACTS TITLE	8 pt
• DRUG FACTS CONTINUED	7 pt
• HEADINGS	7 pt
• SUBHEADINGS/BODY TEXT	6 pt
• LEADING	6.25 pt
• # OF CHARACTERS PER INCH	<39
• BULLETS	5 pt
• SPACE BEFORE BULLET	2 ems
• BARLINES, HAIRLINES	1.5 pt, .5 pt
• SPACE BETWEEN HAIRLINES AND BOX END	2 spaces

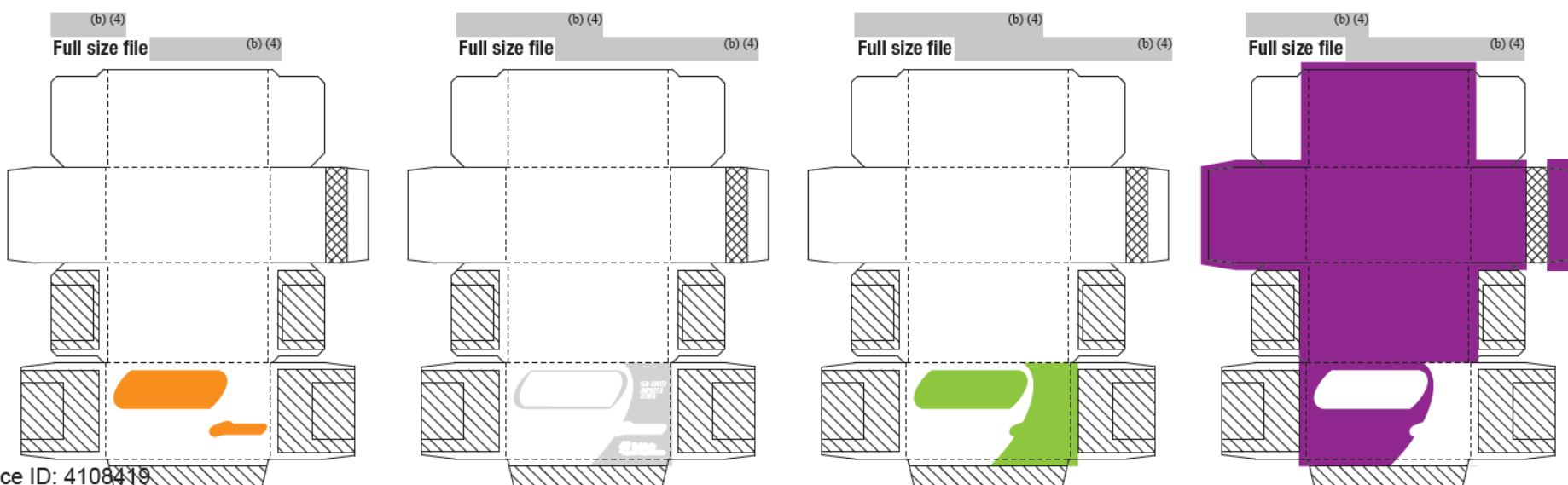



Encode: 8110003057302887831001103113171231

090177e18b0c197b\Final\Final On: 14-Jan-2017 06:10

PRODUCTION

(NOT COLOR ACCURATE)

Job Information	Color Legend
Date 10-FEB-2015 PASS # 1 Component # D000050400 Drawing # Vendor (b) (4)	(b) (4)
Identification (b) (4)	
	Printer & User Notes PRINTER TO REPLACE ALL FPO CODES WITH SCANNABLE ART. PRINTER RESPONSIBLE FOR ALL TRAPPING, VARNISH AND BLEEDS. PRINTER AND USERS RESPONSIBLE FOR PROPER LICENSING OF ALL FONTS USED IN THIS ARTWORK.

**NOTE: ART CONTAINS A LIVE DIGICODE.
 PRINTER RESPONSIBLE FOR ACCURATE REPRODUCTION.**

090177e189bec4ee\Final\Final On: 30-Sep-2016 01:33



← UNVARNISHED AND PRINTED IN BLACK OR DARK BLUE FOR LOT & EXPIRATION AREA.

← 3/16" X 3/16" DATA MATRIX CODE (ECC 200), PRINTED IN BLACK OR DARK BLUE ON UNPRINTED WHITE BACKGROUND.
DATA MATRIX CODE = 080270

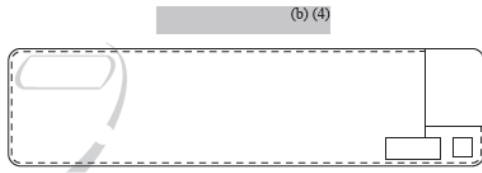

PRODUCTION

(NOT COLOR ACCURATE)

Job Information	Color Legend
Date 22-SEP-2016 PASS # 1 Component # PAA080270 Drawing # (b) (4)-00000435v2	(b) (4)
Identification 	
Printer & User Notes PRINTER TO REPLACE ALL FPO CODES WITH SCANNABLE ART. PRINTER RESPONSIBLE FOR ALL TRAPPING, BLEEDS, COATINGS AND RESOLUTION. PRINTER AND USERS RESPONSIBLE FOR PROPER LICENSING OF ALL FONTS USED IN THIS ARTWORK.	

DRUG FACTS TEXT DEFINED	TYPE SIZE
• HEADINGS	4.5 pt
• SUBHEADINGS/BODY TEXT	4.5 pt
• LEADING	4.5 pt
• BULLETS	3.5 pt
• SPACE BEFORE BULLET	2 ems
• WARNING BOX LINE, HAIRLINES	.5 pt

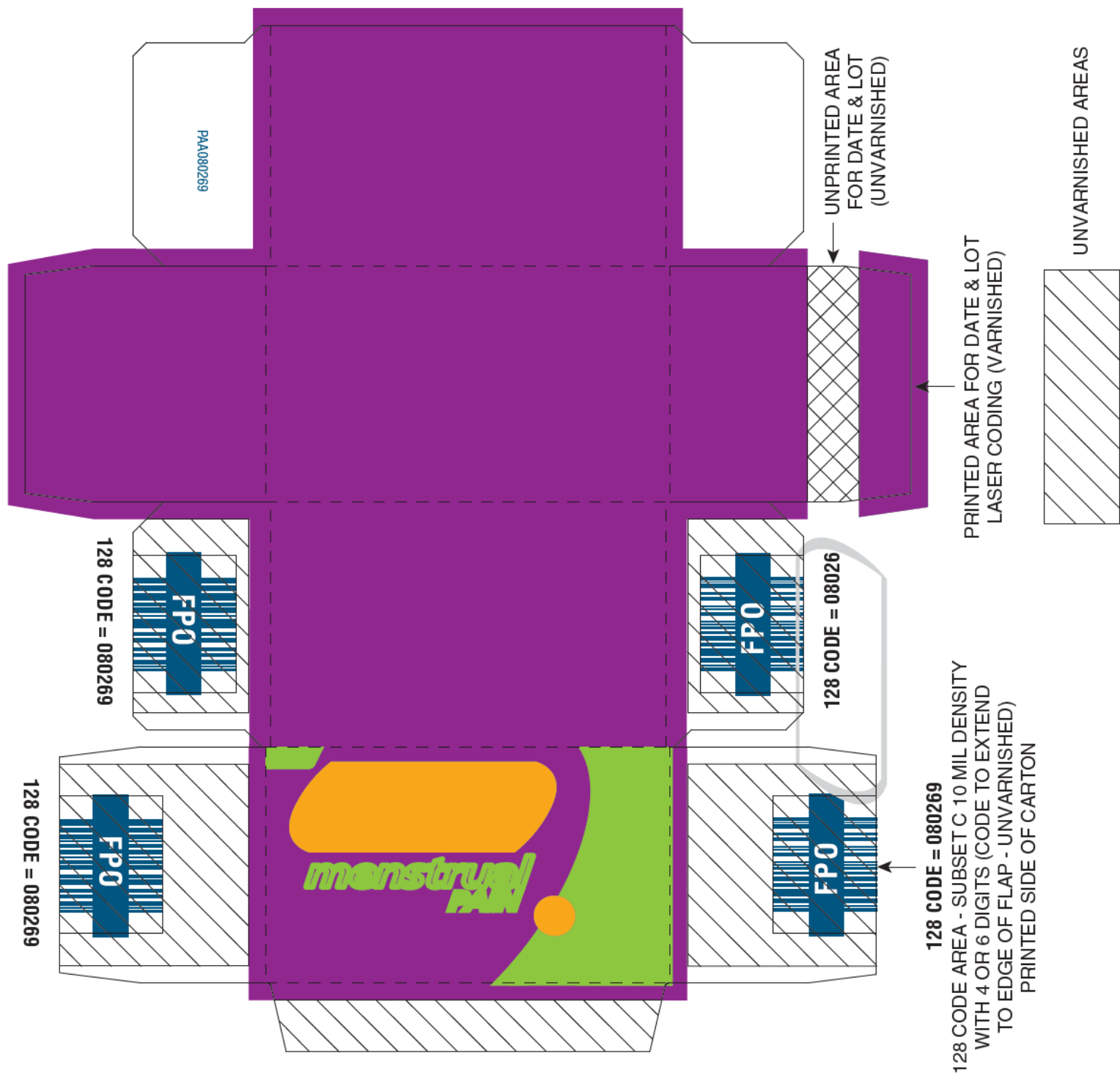

(b) (4)
 Full size file (b) (4)

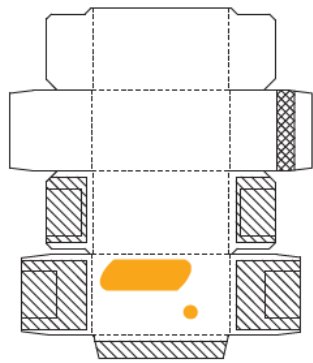

(b) (4)
 Full size file (b) (4)

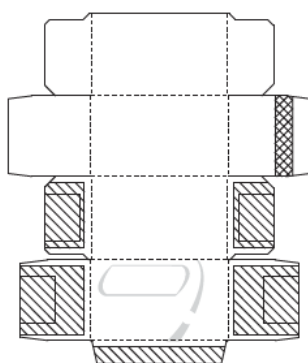

(b) (4)
 Full size file (b) (4)

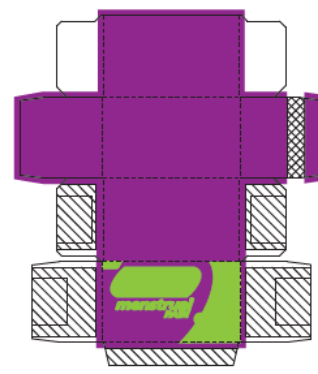

PRODUCTION

(NOT COLOR ACCURATE)

Job Information	Color Legend
Date 22-SEP-2016 PASS # 1 Component # PAA080269 Drawing # (b) (4)-00001119 v04	(b) (4)
Identification	
	Printer & User Notes
	PRINTER TO REPLACE ALL FPO CODES WITH SCANNABLE ART. PRINTER RESPONSIBLE FOR ALL TRAPPING, BLEEDS, COATINGS AND RESOLUTION. PRINTER AND USERS RESPONSIBLE FOR PROPER LICENSING OF ALL FONTS USED IN THIS ARTWORK.

DRUG FACTS TEXT DEFINED	TYPE SIZE
• DRUG FACTS TITLE	8 pt
• DRUG FACTS CONTINUED	7 pt
• HEADINGS	7 pt
• SUBHEADINGS/BODY TEXT	6 pt
• LEADING	6.3 pt
• # OF CHARACTERS PER INCH	<39
• BULLETS	5 pt
• SPACE BEFORE BULLET	2 ems
• BARLINES, HAIRLINES	1.5 pt, .5 pt
• SPACE BETWEEN HAIRLINES AND BOX END	2 spaces

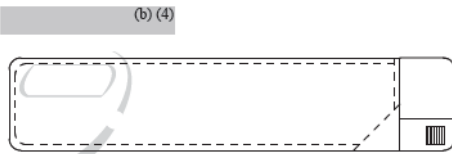
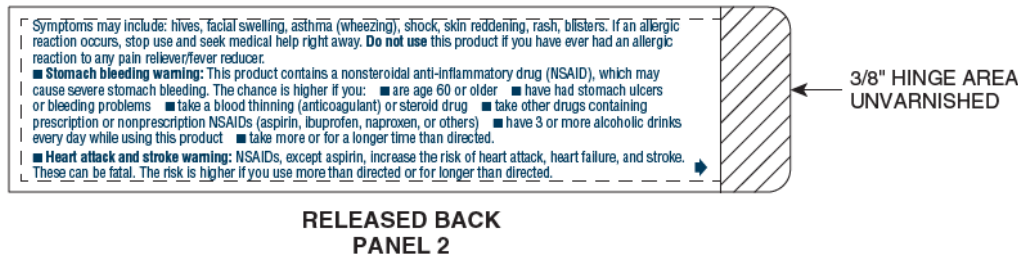
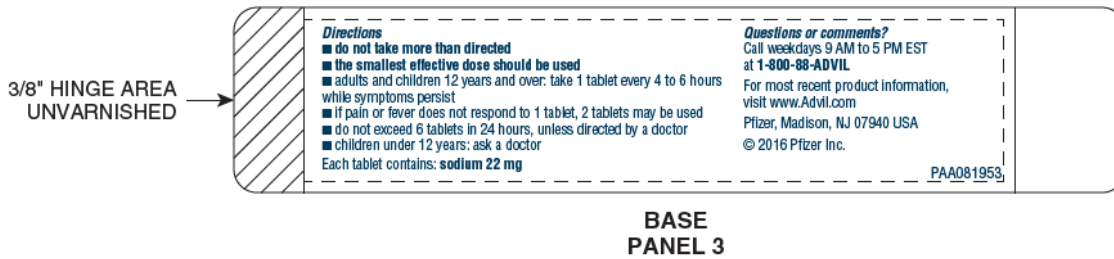
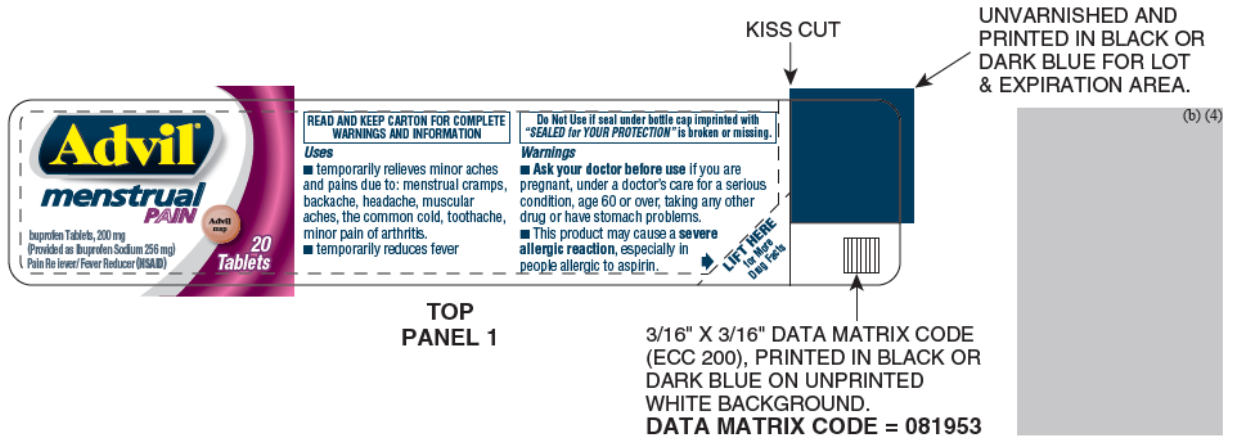

090177e18b0bfb83\Final\Final On: 14-Jan-2017 05:50

PRODUCTION

(NOT COLOR ACCURATE)

Job Information	Color Legend
Date 15-NOV-2016 PASS # 1 Component # PAA081953 Drawing # (b) (4)-00000785v02	(b) (4)
Identification	
	(b) (4)
Printer & User Notes	
PRINTER TO REPLACE ALL FPO CODES WITH SCANNABLE ART. PRINTER RESPONSIBLE FOR ALL TRAPPING, BLEEDS, COATINGS AND RESOLUTION. PRINTER AND USERS RESPONSIBLE FOR PROPER LICENSING OF ALL FONTS USED IN THIS ARTWORK.	

DRUG FACTS TEXT DEFINED	TYPE SIZE
• HEADINGS	6 pt
• SUBHEADINGS/BODY TEXT	6 pt
• LEADING	6.25 pt
• BULLETS	5 pt
• SPACE BEFORE BULLET	2 ems
• WARNING BOX LINE, HAIRLINES	.5 pt

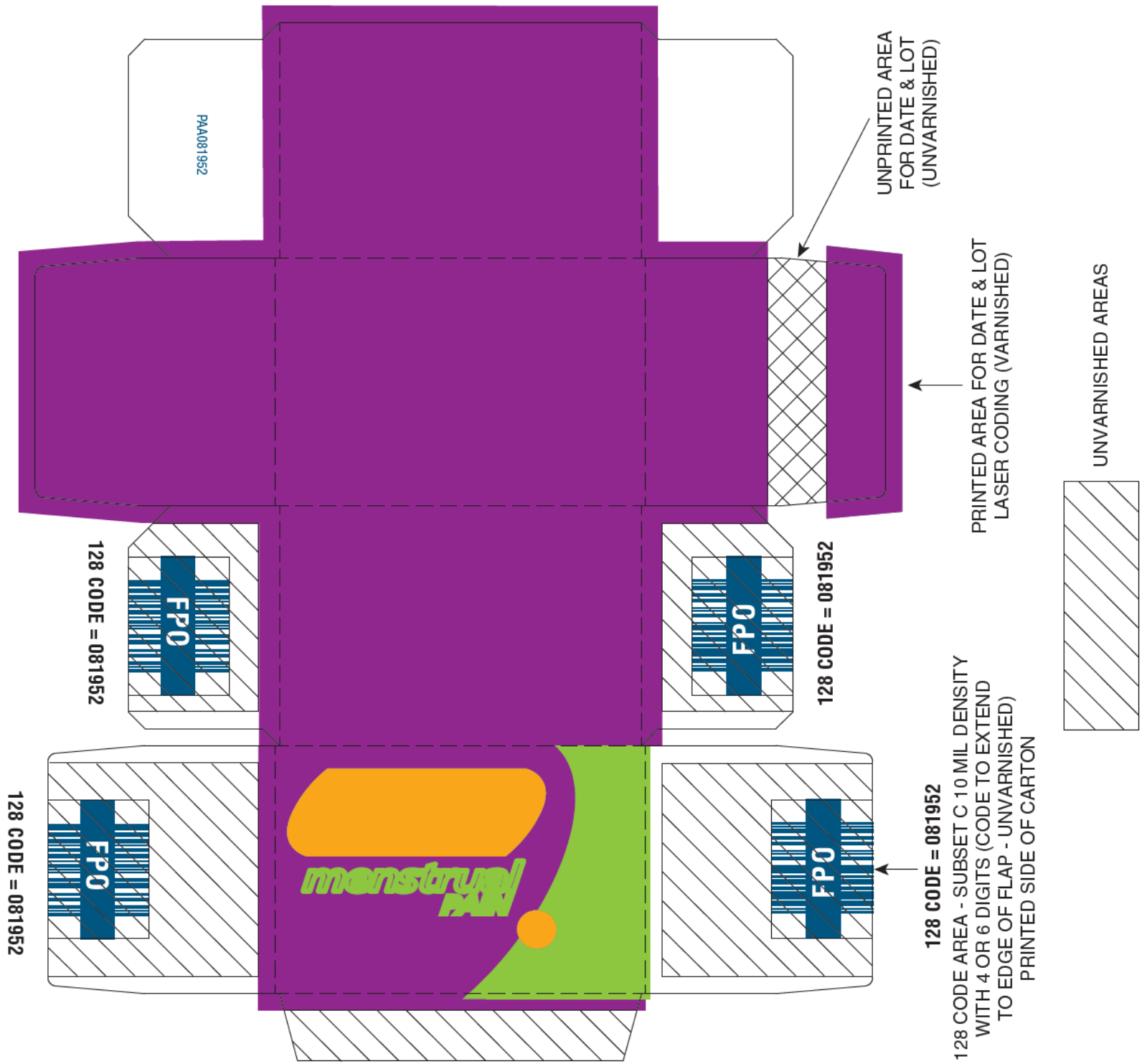

(b) (4)
 Full size file (b) (4)

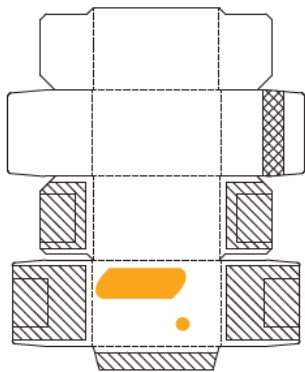

(b) (4)
 Full size file (b) (4)

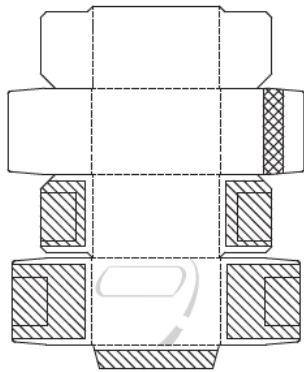

(b) (4)
 Full size file (b) (4)

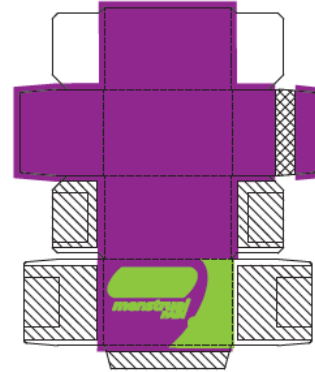

090177e18b0bfb80\Final\Final On: 14-Jan-2017 06:06

PRODUCTION

(NOT COLOR ACCURATE)

Job Information	Color Legend
Date 17-NOV-2016 PASS # 1 Component # PAA081952 Drawing # (b) (4)-00001042v04	(b) (4)
Identification	
	Printer & User Notes
	PRINTER TO REPLACE ALL FPO CODES WITH SCANNABLE ART. PRINTER RESPONSIBLE FOR ALL TRAPPING, BLEEDS, COATINGS AND RESOLUTION. PRINTER AND USERS RESPONSIBLE FOR PROPER LICENSING OF ALL FONTS USED IN THIS ARTWORK.

DRUG FACTS TEXT DEFINED	TYPE SIZE
• DRUG FACTS TITLE	8 pt
• DRUG FACTS CONTINUED	7 pt
• HEADINGS	7 pt
• SUBHEADINGS/BODY TEXT	6 pt
• LEADING	6.25 pt
• # OF CHARACTERS PER INCH	<39
• BULLETS	5 pt
• SPACE BEFORE BULLET	2 ems
• BARLINES, HAIRLINES	1.5 pt, .5 pt
• SPACE BETWEEN HAIRLINES AND BOX END	2 spaces

This is a representation of an electronic record that was signed electronically and this page is the manifestation of the electronic signature.

/s/

KAREN M MAHONEY
06/12/2017