



# HEPZATO KIT™

(melphalan) for Injection/  
Hepatic Delivery System (HDS)

## Instructions For Use

**TABLE OF CONTENTS**

ASSEMBLED SYSTEM – FIGURE 1 ..... 2

SUPPLIED DISPOSABLE COMPONENTS – FIGURE 2..... 3

DESCRIPTION OF SYSTEM COMPONENTS..... 4

INDICATIONS FOR USE ..... 5

WARNING: PERI-PROCEDURAL COMPLICATIONS, MYELOSUPPRESSION ..... 5

CONTRAINDICATIONS ..... 5

WARNINGS AND PRECAUTIONS..... 6

LOCATION OF PROCEDURE ..... 7

PERCUTANEOUS HEPATIC PERFUSION (PHP) PROCEDURE TEAM ..... 7

OTHER CLINICAL TEAM MEMBERS..... 7

PREPARATION: PRIOR TO TREATMENT..... 8

PREPARING AND PRIMING THE EXTRACORPOREAL HEMOFILTRATION CIRCUIT (EFC) ..... 10

PLACING THE CATHETERS ..... 21

ESTABLISHING ANTICOAGULATION & PLACING DOUBLE BALLOON CATHETER ..... 23

CONNECTING CATHETERS TO EXTRACORPOREAL HEMOFILTRATION CIRCUIT ..... 23

ISOLATING THE INFERIOR VENA CAVA ..... 25

BRINGING HEMOFILTRATION CARTRIDGES ONLINE ..... 27

SETUP DRUG DELIVERY SYSTEM AND START EXTRACORPOREAL FILTRATION ..... 28

ENDING EXTRACORPOREAL CIRCULATION ..... 30

CATHETER REMOVAL ..... 31

NORMALIZATION OF COAGULATION STATUS FOR SHEATH REMOVAL..... 31

PROCEDURE FLOWCHART - FIGURE 35..... 32



SUPPLIED DISPOSABLE COMPONENTS – FIGURE 2

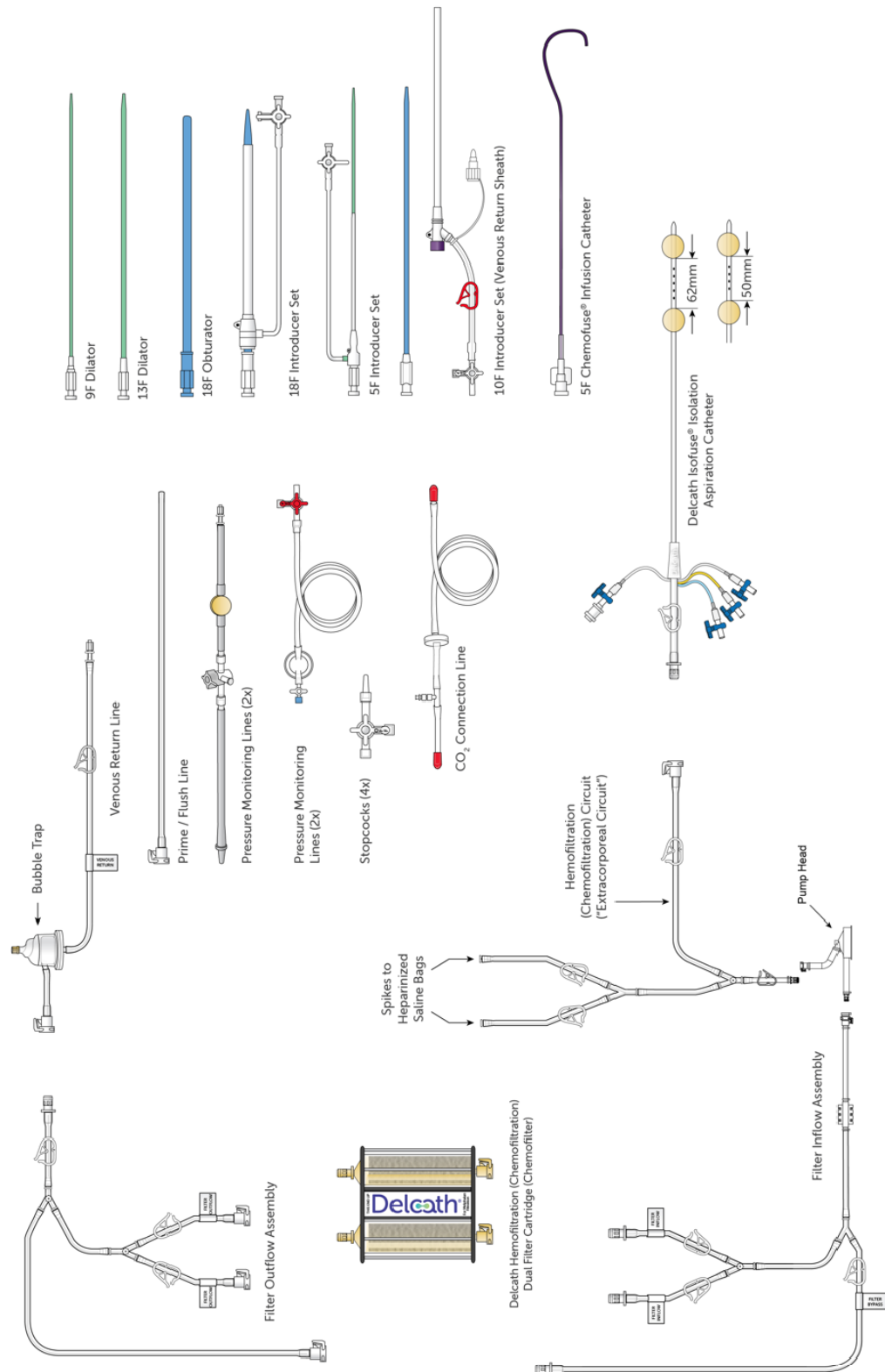

# HEPZATO KIT™

## HEPZATO (melphalan) for Injection/ Hepatic Delivery System

COMPLETE REQUIRED REMS TRAINING BEFORE USING THIS DEVICE FOR THE FIRST TIME. ENSURE YOU COMPLETELY READ AND UNDERSTAND THE INSTRUCTIONS FOR USE.

### DESCRIPTION OF SYSTEM COMPONENTS

HEPZATO KIT™ consists of a closed circuit of catheters and drug-specific filters utilized to deliver Hepzato (melphalan) to the hepatic artery and to lower the concentration of melphalan in the blood before it is returned to systemic circulation. A schematic overview of how the Hepatic Delivery System components work together is presented in [Figure 1: Assembled System](#). The system is designed to be used with a Medtronic Bio-Console® 560 Speed Controller System and TX50P Flow Transducer.

**1. Double Balloon Catheter (DBC)** -- 16F (shaft) polyurethane double balloon catheter that is placed in the retro-hepatic inferior vena cava to isolate the hepatic venous blood and transport it to the Extracorporeal Hemofiltration Circuit for filtration. The catheter has one large (central) drainage lumen and four accessory ports. Due to variation in the length of a patient's retro-hepatic segment of the inferior vena cava and relative positions of hepatic and renal veins, the Double Balloon Catheter is available in two different balloon configurations: 50 mm or 62 mm between the two balloons.

Using pre-operative computed tomography (CT) imaging, or by performing an inferior vena cavogram prior to placement of the Double Balloon Catheter, estimate the length of the retro-hepatic segment of the inferior vena cava and the relative positions of hepatic and renal veins in order to determine the optimum Double Balloon Catheter balloon spacing: 50mm or 62mm.

Two of the accessory ports are used to inflate low-pressure occlusion balloons, which are inflated independently to occlude the inferior vena cava above and below the hepatic veins. When inflated, the cephalic (superior – blue port) balloon obstructs the inferior vena cava above the hepatic veins and the caudal (inferior – yellow port) balloon obstructs the inferior vena cava below the hepatic veins, thus isolating hepatic venous blood in the fenestrated segment between the balloons.

The large drainage lumen with a quick connect fitting is a conduit to the fenestrations between the two occlusion-balloons. The fenestrations allow the hepatic venous blood to flow into the drainage lumen and exit the catheter at the proximal end.

The third accessory (translucent) port labeled "CONTRAST" is for injections of iodinated contrast medium through the fenestrations, to check catheter position.

The fourth accessory port (white) is used for over-the-guidewire (OTW) introduction and positioning of the catheter in the retro-hepatic inferior vena cava. This lumen also has a small port opening along the catheter shaft positioned inferior to the caudal balloon and exits at the distal tip, to allow inferior vena cava blood, proximal to the caudal balloon, to bypass the occluded segment of the inferior vena cava and flow into the right atrium.

### 2. Accessory Pack

- **9F and 13F Dilator Set** -- These over-the-wire dilators are used to widen the subcutaneous space and venous entry site in preparation for the placement of the 18F Introducer Set.
- **18F Introducer Set (Sheath and Dilator)** -- The 18F introducer sheath and coaxial dilator are to be placed over a wire; the dilator is removed, and the sheath is available for the insertion of the Double Balloon Catheter or the 18F Obturator.
- **18F Obturator** -- An 18F obturator is used to occlude and support the 18F sheath lumen when it is not in use, and upon removal of the Double Balloon Catheter at the end of the procedure.
- **5F Introducer Set (Sheath and Dilator)** -- A 5F hemostasis sheath is used to facilitate the introduction of the 5F Infusion Catheter through the femoral artery.
- **10F Introducer Set (Venous Return Sheath)** -- A 10F sheath used to return the filtered hepatic venous blood through the internal jugular vein. A 3-way high-flow stopcock is included as part of the 10F Introducer Set. The high-flow stopcock is attached to the Venous Return Sheath and then to the male connector of the Extracorporeal Hemofiltration Circuit, if required. This sheath may also be used for hydration.

**3. 5F Infusion Catheter** -- 5F arterial catheter is used to deliver Hepzato into the proper hepatic artery or it can be used to coaxially introduce a microcatheter, if, at the discretion of the Interventional Radiologist, a microcatheter is preferred for selective catheter tip placement for the drug infusion. The following microcatheters have been qualified for use with the Hepzato KIT™ - select one of the microcatheters below. See microcatheter manufacturer's Instructions for Use. These microcatheters are NOT PROVIDED by Delcath:

- Merit Maestro (Merit Medical Systems, Inc., So. Jordan, UT, USA)
- Boston Scientific Renegade Hi-Flo (Boston Scientific Corp., Natick, MA, USA)
- Terumo Progreat (Terumo Medical Corp., Somerset, NJ, USA)

**4. Delcath Hemofiltration Dual Filter Cartridge** -- One single-use Dual Filter Cartridge designed with the filter cartridges arranged in parallel to lower the concentration of Hepzato (melphalan) in systemic circulation. The cartridge frame comes with a built-in pole clamp.

Filter mechanism of action: The filter is composed of activated carbon for adsorption and removal of HEPZATO. The pore structure of the filter media along with its particle size and shape contribute to rapid HEPZATO adsorption where large quantities (70 cc/100 g of carbon with melphalan) are adsorbed during a first pass through the filter *Flow rates should be between 0.4 Liters/minute to 0.8 Liters/minute, to ensure the appropriate removal of the HEPZATO from the blood during the 30-minute infusion period and continue to remove residual drug during the 30-minute wash out period.*

**5. Extracorporeal Hemofiltration Circuit (EFC)** -- The Extracorporeal Hemofiltration Circuit is used to transport the hepatic venous blood, which has been isolated by the Double Balloon Catheter and aspirated into the fenestration lumen, through the Hemofiltration Cartridges and back to the patient through the Venous Return Sheath. Connections are provided for infusion of normal saline. This circuit includes:

- Medtronic AP40 Affinity™ CP Centrifugal Pump ("Pump Head"), a disposable pump head to be used with a pump console manufactured by Medtronic, Inc. - see manufacturer's Instructions for Use for Pump Head. (Note: The Medtronic, Inc. Bio-Console 560 (extracorporeal blood pumping) System is required for use with the Hepatic Delivery System: This is NOT PROVIDED by Delcath).
- Medtronic Bio-Probe® DP-38P blood flow monitoring insert ("Flow Probe"), a disposable flow probe to be used with a blood flow monitoring transducer manufactured by Medtronic, Inc. - see manufacturer's Instructions for Use for Flow Probe. The Flow Probe is used to measure the rate of blood flow during the procedure. (Note: The Medtronic Bio-

Probe TX50P blood flow monitoring transducer is required for use with the Hepatic Delivery System: This is NOT PROVIDED by Delcath).

- Prime/Flush Line to be used to prime the system and flush the filter after system is fully de-bubbled (de-gassed).
- Pressure Monitoring Lines allow measuring the positive and negative pressure pre- and post- pump head.
- High Flow Stopcocks to allow the CO<sub>2</sub> Connection Line and the pressure monitoring lines to be attached to the assembled circuit.
- Venous Return Line to be attached post system prime and flush so that the circuit can be attached to the 10F Venous Return Sheath.

**6. Carbon Dioxide (CO<sub>2</sub>) Connection Line** -- The CO<sub>2</sub> Connection Line is used to deliver sterile CO<sub>2</sub> gas to the Hemofiltration Cartridges to aid in priming/debubbling the filter cartridge, prior to the start of the procedure. The CO<sub>2</sub> Line has no patient contact.

**WARNING**

Only the components provided in the HEPZATO KIT or specified by Delcath Systems, Inc. in the “not included” box below are to be used to create the circuit. There should be no substitutions. The circuit has not been validated for use with other components.

Do not disassemble the components provided in the Hepatic Delivery System as this may damage the components.

**NOT INCLUDED:**

- Bubble Trap holder
- Medtronic Bio-Console 560 Speed Controller System (“Pump”)
- Medtronic 560A (“Motor Drive”)
- Medtronic Bio-Probe TX50P (“Flow Transducer”)
- CO<sub>2</sub> Supply for Priming Dual Filter
- Drug Injector: must be able to inject at a rate of 25 mL/minute
- Drug Delivery Disposables:
  - One (1) Medrad 150mL Syringe (Polypropylene (PP)-Barrel & Polyisoprene-Plunger) or equivalent
  - Two (2) Intravenous Administration Set with spike & drip chamber (Polyvinylchloride (PVC)-tubing, Acrylonitrile butadiene styrene (ABS) & Polyethylene (PE)-Drip Chamber & Polycarbonate (PC)-Luer) or equivalent
  - One (1) - 48” injector lines (PVC-Tubing & PC-Luer) or equivalent
  - Five (5) 3-way stopcocks (PC-body, High Density Polyethylene (HDPE) or Acetal-Handles) or equivalent
  - Three (3) 20 mL syringes (PP-Barrel & Polyisoprene-Plunger) or equivalent
- Microcatheters (Maximal Distal End OD = 2.8F) – for Selective Drug Infusion (at Interventional Radiologist discretion). Select one from Delcath qualified microcatheters listed below:
  - Merit Maestro (Merit Medical Systems, Inc., So. Jordan, UT, USA)
  - BSC Renegade Hi-Flo (Boston-Scientific Corp.; Natick, MA, USA)
  - Terumo Progreat (Terumo Medical Corp., Somerset, NJ, USA)

**INDICATIONS FOR USE**

HEPZATO KIT™, containing HEPZATO for injection, is indicated as a liver-directed treatment for adult patients with uveal melanoma with unresectable hepatic metastases affecting less than 50% of the liver and no extrahepatic disease or extrahepatic disease limited to the bone, lymph nodes, subcutaneous tissues, or lung that is amenable to resection or radiation.

**WARNING: PERI-PROCEDURAL COMPLICATIONS, MYELOSUPPRESSION**

Severe peri-procedural complications including hemorrhage, hepatocellular injury, and thromboembolic events may occur via hepatic intra-arterial administration of HEPZATO. Assess patients for these adverse reactions during and for at least 72 hours following administration of HEPZATO. HEPZATO KIT is available only through a restricted program under a Risk Evaluation and Mitigation Strategy called the HEPZATO KIT REMS. Myelosuppression with resulting severe infection, bleeding, or symptomatic anemia may occur with HEPZATO. Monitor hematologic laboratory parameters and delay additional cycles of HEPZATO therapy until blood counts have improved.

**CONTRAINDICATIONS**

HEPZATO KIT is contraindicated in patients with:

- Active intracranial metastases or brain lesions with a propensity to bleed
- Liver failure, portal hypertension, or known varices at risk for bleeding
- Surgery or medical treatment of the liver in the previous 4 weeks
- Uncorrectable coagulopathy
- Inability to safely undergo general anesthesia, including active cardiac conditions including, but not limited to, unstable coronary syndromes (unstable or severe angina or myocardial infarction), worsening or new-onset congestive heart failure, significant arrhythmias, or severe valvular disease
- History of allergies or known hypersensitivity to melphalan
- History of allergies or known hypersensitivity to a component or material utilized within the HEPZATO KIT including:
  - History of allergy to natural rubber latex
  - History of allergy or hypersensitivity to heparin or presence of heparin-induced thrombocytopenia (HIT)
  - History of severe allergic reaction to iodinated contrast not controlled by premedication with antihistamines and steroids

## WARNINGS AND PRECAUTIONS

PLEASE CAREFULLY READ AND UNDERSTAND THE LIST OF WARNINGS AND PRECAUTIONS BELOW AS SERIOUS INJURY, ILLNESS OR DEATH OF THE PATIENT CAN OCCUR IF THESE WARNINGS AND PRECAUTIONS ARE NOT PROPERLY FOLLOWED.

### Peri-Procedural Complications

Hemorrhage, hepatocellular injury, and thromboembolic events have been observed when HEPZATO has been administered via hepatic intra-arterial administration. Administration of HEPZATO KIT requires general anesthesia and extracorporeal bypass of circulation which may cause life threatening or fatal adverse effects. Ensure the patient is euolemic but do not overhydrate the patient. Monitor for these peri-procedural complications during the procedure and for at least 72 hours following the procedure.

To mitigate the risk of thromboembolic events, administer anticoagulation as described in the IFU during the procedure.

Due to the risk of bleeding, do not use in patients with uncorrectable coagulopathies and delay treatment with the HEPZATO KIT for at least 4 weeks after surgery or other medical procedure involving the liver. Platelets and clotting factors may be removed during the HEPZATO KIT procedure. Monitor platelets and coagulation parameters as described in the IFU. If life-threatening bleeding occurs during the procedure, reverse anticoagulation as described in the IFU and correct coagulopathy as appropriate. Discontinue anticoagulation with warfarin or other oral anticoagulants prior to the procedure until hemostasis has been restored after the procedure and no bleeding complications have been observed. Refer to the Prescribing Information of the anticoagulant agent for bridging recommendations for anticoagulation prior to surgical procedures. Discontinue drugs affecting platelet function such as aspirin, non-steroidal anti-inflammatory drugs, or other anti-platelet drugs one week before the procedure.

Patients with abnormal hepatic vascular (especially arterial supply) or biliary (especially re-implantation of bile duct) anatomy or gastric acid hypersecretion syndromes may be at increased risk of peri-procedural complications or other severe adverse reactions. Screen patients for a history of prior surgeries involving the bile duct to assess whether the patient is an appropriate candidate for HEPZATO KIT and monitor patients for adverse reactions following HEPZATO KIT administration.

Procedure-related reductions in blood pressure including severe hypotension can occur during the HEPZATO KIT procedure. Closely monitor blood pressure during the procedure. Patients may require fluid support and vasopressors. To reduce the risk of severe hypotension, assess hypothalamic-pituitary-adrenal axis function, and temporarily discontinue ACE-inhibitors, calcium channel blockers, or alpha-1-adrenergic blockers for at least 5 half-lives prior to treatment with the HEPZATO-KIT. If necessary, use other short-acting antihypertensive drugs to manage blood pressure during the peri-procedure period.

### HEPZATO KIT REMS Program

The HEPZATO KIT is only available through a restricted program under a REMS, because of the risk of severe peri-procedural complications including hemorrhage, hepatocellular injury, and thromboembolic events defined in the REMS. The HEPZATO KIT should only be used by trained healthcare providers [see HEPZATO USPI Warnings and Precautions (5.2)].

Important requirements of the HEPZATO KIT REMS include:

Healthcare settings that dispense and administer HEPZATO KIT must be enrolled, certified, and comply with the REMS requirements.

Certified healthcare facilities must ensure that healthcare providers who perform the Percutaneous Hepatic Perfusion (PHP) procedure are trained on the use of HEPZATO KIT and must only dispense HEPZATO when authorized to do so.

Certified healthcare facilities must ensure that patients are assessed for severe peri-procedural complications during the procedure and for at least 72 hours following the procedure.

Further information is available at [www.HEPZATOKITREMS.com](http://www.HEPZATOKITREMS.com) or contact Delcath Systems at 1-833-632-0457.

### Myelosuppression

Hematologic adverse reactions, including thrombocytopenia, anemia, and neutropenia have been reported in patients treated with HEPZATO. The risk of hematologic adverse reactions may be increased in patients who have received prior chemotherapy, bone irradiation, or who have compromised bone marrow function.

In the 95 patients who received HEPZATO KIT in the FOCUS trial, 68% had Grade 3 or 4 myelosuppression. A total of 55%, 33%, and 30% experienced Grade 3 or 4 thrombocytopenia, anemia, and neutropenia, respectively. Median time to thrombocyte nadir was 13 days (range: 3-33) after treatment with median recovery in 20 days (range: 4-29) after treatment. Median time to hemoglobin nadir was 10 days (range: 3-21) after treatment with median recovery in 13 days (range: 4-28) after treatment. Median time to neutrophil nadir was 11 days (range: 3-36) after treatment with median recovery in 17 days (range: 9-36) after treatment.

Monitor patients for severe infections, bleeding, and symptomatic anemia. Only administer HEPZATO in patients with platelets >100,000/microliter, hemoglobin ≥10.0 gm/dL and neutrophils >2,000/microliter. Administer transfusions or growth factors as appropriate [see HEPZATO USPI Dosage and Administration (2.1)].

### Hypersensitivity Reactions

Hypersensitivity reactions, including anaphylaxis, have occurred in approximately 2% of patients who received an intravenous (IV) formulation of melphalan. These reactions with melphalan are characterized by urticaria, pruritus, edema, skin rashes, and in some patients, tachycardia, bronchospasm, dyspnea, and hypotension. Hypersensitivity can occur in patients with or without prior exposure to IV or oral melphalan.

When a hypersensitivity reaction is observed, immediately terminate the hepatic arterial melphalan infusion and administer necessary supportive care [see HEPZATO USPI Contraindications (4), and Adverse Reactions (6.1)].

Patients with a history of allergic reactions to iodinated contrast may experience hypersensitivity reactions, including anaphylaxis, during treatment with the HEPZATO KIT. Premedicate patients with a history of allergic reaction to iodinated contrast prior to treatment with HEPZATO KIT. Do not administer HEPZATO KIT in patients with a history of severe allergic reactions or anaphylaxis to iodinated contrast [see IFU contraindications and HEPZATO USPI Contraindications (4)].

### Gastrointestinal Adverse Reactions

Gastrointestinal adverse reactions including nausea and vomiting, abdominal pain, and diarrhea are common, and occurred in 84% of patients treated with HEPZATO KIT in the FOCUS trial. Administer a proton-pump inhibitor (PPI) the day prior to and the morning of the procedure. If anti-emetic treatment is required, pre-medicate with anti-emetic therapy in subsequent cycles.

### Secondary Malignancies

Melphalan has been shown to cause chromatid or chromosome damage in humans. Secondary malignancies, including acute nonlymphocytic leukemia, myeloproliferative syndrome, and carcinoma, have been reported in patients with cancer treated with intravenous alkylating drugs including melphalan. Some patients also received other chemotherapeutic agents or radiation therapy. Precise quantification of the risk of acute leukemia, myeloproliferative syndrome, or carcinoma is not possible. Published reports of leukemia in patients who have received oral or IV melphalan (and other alkylating drugs) suggest that the risk of leukemogenesis increases with chronicity of treatment and with cumulative dose [see HEPZATO USPI Nonclinical Toxicology (12.1)].

**Embryo-Fetal Toxicity**

Based on animal studies and its mechanism of action, melphalan can cause fetal harm when administered to a pregnant woman. Melphalan is genotoxic, targets actively dividing cells, and was embryolethal and teratogenic in rats. Advise pregnant women of the potential risk to a fetus. Advise females of reproductive potential to use effective contraception during treatment with melphalan and for 6 months after the last dose. Advise males with female partners of reproductive potential to use effective contraception during treatment with HEPZATO and for 3 months after the last dose [see HEPZATO USPI Use in Specific Populations (8.1, 8.3), Nonclinical Toxicology (13.1)].

**Infertility**

Melphalan-based chemotherapy regimens have been reported to cause suppression of ovarian function in premenopausal women, resulting in persistent amenorrhea in approximately 9% of patients. Reversible or irreversible testicular suppression has also been reported [see HEPZATO USPI Use in Specific Populations (8.3)].

**LOCATION OF PROCEDURE**

The procedure must be performed in an appropriately equipped interventional radiology suite with fluoroscopy or an operating room designed and equipped similarly. Resuscitation personnel, equipment, and medications must be immediately available.

**PH**

A qualified pharmacist, on call during the procedure, to reconstitute the chemotherapeutic agent HEPZATO (melphalan), using national and local safety guidelines. The pharmacist should be aware of the rapid preparation time required for the preparation and administration of HEPZATO for use with the Hepatic Delivery System.

**DD**

A qualified chemotherapy healthcare professional certified by the site to deliver chemotherapy, such as Interventional Radiology Technician or Registered Nurse.

**IN**

A qualified intensivist, or appropriately qualified critical care specialist, responsible for providing medical management (reversing coagulopathy and blood product support) of the patient in the immediate post-procedure period during which the patient is in the intensive care unit or step-down unit.

**Percutaneous Hepatic Perfusion (PHP)  
PROCEDURE TEAM**

PHP Procedure team members are the Interventional Radiologist, the Perfusionist and the Anesthesiologist.

**IR**

A qualified interventional radiologist with the knowledge, skills, experience, and hospital privileges required to perform advanced vascular interventional procedures.

**PF**

A qualified perfusionist to establish, monitor, and control the extracorporeal pump and veno-venous bypass circuit.

**AN**

A qualified anesthetist (anesthesiologist) and/or nurse anesthetist responsible for the management of sedation, analgesia, respiratory and cardiovascular support.

The PHP procedure team (IR, PF, AN) is required to complete the Risk Evaluation and Mitigation Strategy (REMS) training. Refer to Procedure Flowchart (Figure 35) which provides an overview of the procedure and how the PHP procedure team and their tasks work together. All REMS materials are available at [www.HEPZATOKITREMS.com](http://www.HEPZATOKITREMS.com) or by calling the REMS Coordinating Center at 1-833-632-0457.

To facilitate use of these instructions, the procedural sections include Healthcare User Identifiers to assist each user in identifying procedural steps applicable to them.

**OTHER CLINICAL TEAM MEMBERS**

Other clinical team members include the medical/surgical oncologist, pharmacist, chemotherapy healthcare professional and intensivist.

**O**

A qualified medical/surgical oncologist experienced in the monitoring of toxicities of chemotherapy and who is responsible for the complete medical management of the patient, including, but not limited to, pre- and post-operative care. The medical/surgical oncologist may also be responsible for monitoring the patient during the immediate post-procedure period.

- The medical/surgical oncologist will also play a unique role in communicating about chemotherapeutic agent (HEPZATO) and the Hepatic Delivery System risks and coordinating with other oncologists and key health care professionals responsible for patient follow-up care and monitoring for post-procedure toxicities.

## PROCEDURE

### PREPARATION: PRIOR TO TREATMENT



All medications and supportive measures must be determined and administered in accordance with each institution's policies, guidelines, procedures, and the HEPZATO KIT prescribing information.

Before starting the procedure, confirm that all components of the HEPZATO KIT are available for assembly. Note: Certain components are not supplied by Delcath. Verify that the Medtronic pump is functioning properly (see pump operating manual for instructions on proper functionality).

#### Hepatic Vascular Mapping - Angiography and Embolization

To deliver HEPZATO to the whole liver and avoid inadvertent infusion of HEPZATO into the gastrointestinal or visceral branches, conduct a thorough hepatic artery angiogram and investigation of variant hepatic and gastric artery anatomy. In addition, embolization of certain branches supplying the gastro-intestinal tract may be necessary.

### WARNING

If the perfusion of melphalan cannot be isolated from the systemic circulation, stop the drug infusion immediately.

- Evaluate the portal vein for patency with late imaging during celiac and superior mesenteric arteriography. The presence of portal venous hypertension is a contraindication for treatment with HEPZATO via the HEPZATO KIT.
- Completely examine the arterial supply to the liver and assess and understand its impact on chemotherapy infusion. Use of a selective micro-catheter may facilitate both embolization and subsequent drug infusion.
- Assess liver blood supply and formulate a strategy for catheter placement to ensure drug infusion to the entire liver. If the risk assessment is unfavorable or the anatomic variation is too complex to allow whole liver or sequential lobar catheterization for safe delivery of melphalan, the procedure must not be performed.
- Depending on vascular anatomy, a sequential lobar approach may be the best administration option which requires splitting the HEPZATO dose. This will require repositioning of the catheter during the procedure.
- A whole liver infusion (dosing) approach will likely require embolization of the gastroduodenal artery but depends on its origin relative to the side branches of the distal proper hepatic artery. If the infusion catheter tip can be placed sufficiently distally to avoid retrograde reflux into the gastroduodenal artery, then the latter may not need to be embolized.

#### Double Catheter Balloon Sizing

- The double catheter balloon has two sizes representing the inter-balloon spacing distance. Spacing is based on hepatic venous anatomy and avoidance of renal vein occlusion. An inter balloon sizing should assure full isolation of all hepatic veins without occluding renal veins. Review computed tomography or magnetic resonance imaging to assess venous anatomy. Select KIT (balloon spacing) based on patient anatomy.

#### Coagulation Studies

- Perform coagulation studies pre-, peri- and post-procedure then repeat until normalized. Parameters tested must include:
  - Partial Thromboplastin Time
  - Prothrombin Time / International Normalized Ratio

#### Blood Products

Type and cross-match depending on institutional guidelines for:

- Red blood cells

- Fresh Frozen Plasma
- Platelets
- Cryoprecipitate

#### Hydration

- Pre procedural hydration is required if patient is determined to be hypovolemic. Do not over hydrate the patient pre-, peri- or post procedure. Overhydration has been associated with procedural and post-procedural complications.
- Procedural hydration is required since 700 mL or more of blood will be displaced into the extracorporeal circulation. A mixture of colloids and crystalloids are used to replace this volume and steadily maintain mean arterial pressure above 60 mmHg during the procedure. Typically, total procedural fluid requirements range between 1,500 and 3,000 mL.
- A Foley catheter is recommended to closely monitor fluid balance during hydration. If the patient is stable, remove within 24 hours after the procedure.

#### Allopurinol

- As a prophylaxis for electrolyte abnormalities, patients with more than 25% replacement of normal liver parenchyma with tumor are to be given allopurinol 300 mg/day orally beginning two (2) to three (3) days prior to percutaneous hepatic perfusion (PHP) with the Hepatic Delivery System and continuing two (2) to three (3) days following procedure.

#### Proton Pump Inhibitors

- Administer prophylactic proton pump inhibitors (for example: omeprazole, one 20 mg delayed release capsule by mouth) the day before and the morning of the procedure.

#### Anticoagulation

- The patient will be systemically anticoagulated with heparin during the procedure. Systemic anticoagulation is required to reduce the risk of thrombus formation including formation of thrombi that may impede free extracorporeal flow and filtration. Activated clotting time must be closely monitored to ensure adequate anticoagulation.
  - Obtain the baseline activated clotting time value.
  - Administer heparin to the patient only AFTER placement of the 18F (femoral vein), 10F (jugular vein), and 5F (femoral artery) sheaths. Ultrasound guidance and single anterior wall puncture technique are recommended during sheath placement to avoid bleeding complications.
  - The patient must be fully heparinized prior to the insertion of the Double Balloon Catheter into the inferior vena cava. Begin with an initial intravenous bolus of heparin at 300 units/kg, dose adjusted to achieve activated clotting time.
  - A minimum activated clotting time (ACT) of 400 seconds is necessary with a recommended ACT value > 450 seconds
  - Evaluate activated clotting time frequently (approximately every 5 minutes) until adequate anti-coagulation is established (ACT > 400 seconds).
  - DO NOT insert double balloon catheter into the patient Until ACT values are > 400 seconds.
  - Maintain activated clotting time at > 400 seconds throughout the procedure, assessing ACT values every 15 – 30 minutes depending on the patient's response and administering intravenous heparin as needed.

#### Anesthetic Management

- Treatment must be administered with patients being monitored and under general anesthesia. Emergency resuscitation equipment must be available during the procedure.

#### Blood Pressure Control

- Expect significant procedure related decrease of blood pressure when the balloons occlude blood return from the inferior vena cava (decreased cardiac inflow) and when the filters are brought into the extracorporeal bypass circuit. The reasons for filter-related hypotension are

multifactorial, but hypersensitivity to non-physiological surfaces (inflammatory response), significant reduction in venous return and preload, and possible removal of catecholamines by the filters may play a role. To aid blood pressure maintenance for extracorporeal bypass, the following actions are recommended per institutional practice:

- Pre-operative hydration and intra-procedural administration of colloids and crystalloids.
- Vasopressor use in accordance with institutional practices to elevate mean arterial pressure to a target >65 mmHg
- Blood pressure must be constantly monitored throughout the procedure and maintained at levels required for adequate perfusion of critical end-organs (i.e., >65 mmHg).

#### **Drug Preparation and Delivery Planning**

- Prior to set up, provide pre-notification to the hospital pharmacy to be ready to reconstitute HEPZATO for injection.
- HEPZATO reconstitution and delivery should be coordinated and timed so that the start of the infusion of the melphalan is within thirty minutes of preparation. Drug administration should be completed within 60 minutes of the start of preparation.
- The filters should not be brought online until HEPZATO is in the procedure room. This minimizes filtration duration and associated complications.

**CAUTION:** Adherence to strict sterile procedures is always mandatory

1. **Assemble EFC**

See [Figure 1](#) (Assembled System) for reference to a completely assembled circuit.

- (a) Utilizing strict aseptic technique, heparinize nine (9) liters of 0.9% Sodium Chloride Injection (normal saline) by adding 2,000-5,000 units of heparin per liter.
- (b) Remove Hemofiltration Dual Filter Cartridge from sterile pouch.
- (c) Attach the filter to the intravenous pole using the built-in pole mount clamp, see [Figure 3](#).

*Figure 3: Filter mount*

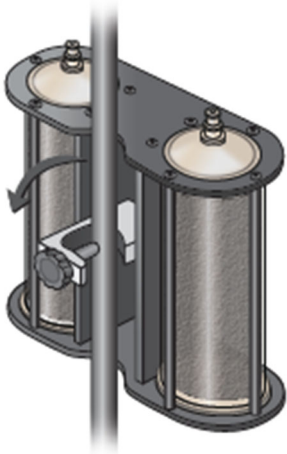

- (d) Refer to "THIS END UP" label on filter faceplate, see [Figure 4](#).

*Figure 4: Filter Orientation*

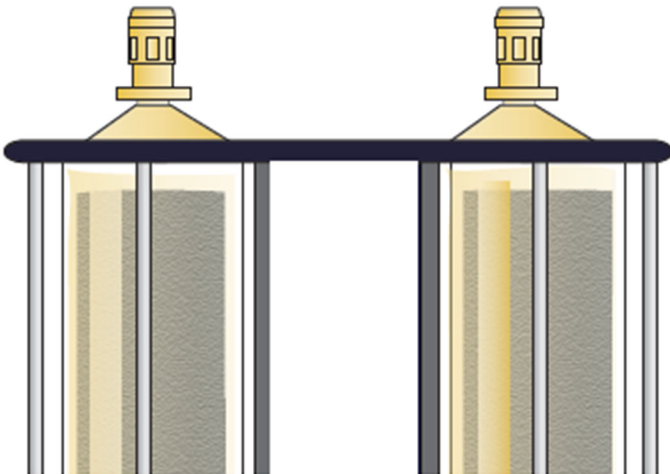

- (e) Open the circuit tray and remove the components that are in the pouches. Set aside for later assembly.
- (f) Remove the "Filter Inflow Assembly" and "Pump Head Assembly" sections from the circuit tray, see **Figure 5**.
  - i. Connect Filter Inflow Assembly to Pump Head outlet
  - ii. Connect DBC Assembly to Pump Head inlet
  - iii. Place pump head on the pump drive motor
  - iv. Insert flow probe into flow transducer

**Figure 5: Filter Inflow Assembly**

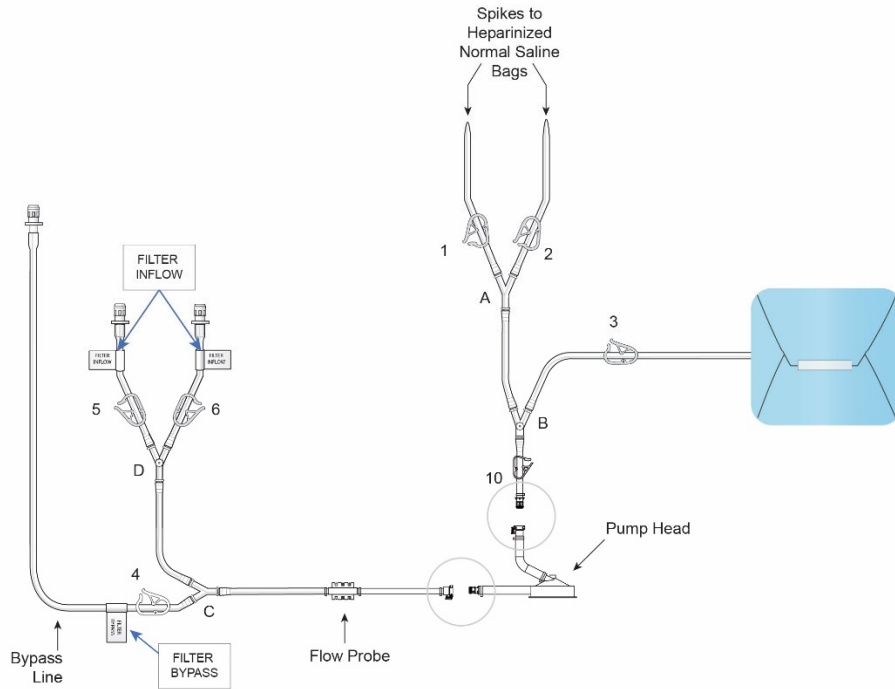

- (g) Connect the two Inflow lines (labeled and identified as in **Figure 6**) to the cartridge inlet connectors located on the bottom of the dual filter. To complete the assembly, push each of the quick connector couplings together, as shown in **Figure 6** (male to female) until an audible "click" is heard to verify connection (push and click).

**Figure 6: Filter Inflow Assembly Connection**

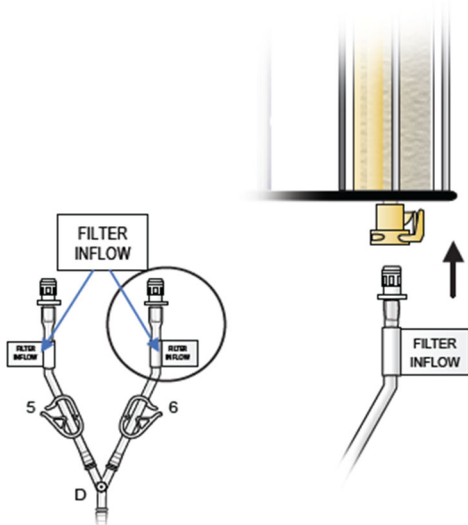

- (h) Remove the "Filter Outflow Assembly" section from its sterile pouch, see **Figure 7**.

**Figure 7: Filter Outflow Assembly Connection**

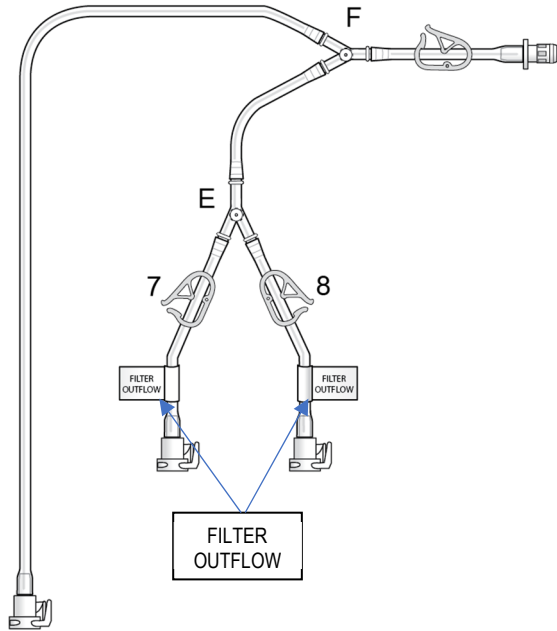

- (i) Connect the two outflow lines to the filter cartridge outlet connectors located on the top of the dual filter using the quick connector couplings (push and click). Identify assembly labels as in **Figure 8**.

**Figure 8: Filter Outflow Line Connection**

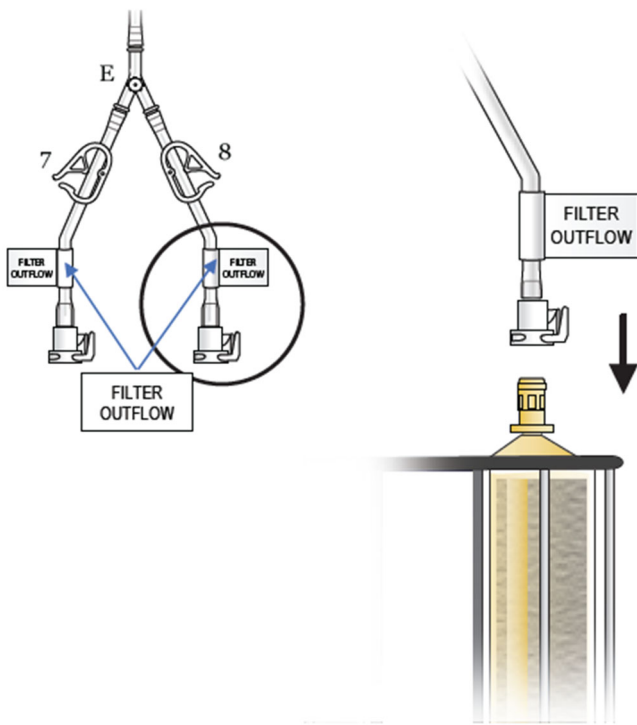

- (j) Assemble the two ends of the bypass line by pushing the quick connectors together (push and click), see **Figure 9** (black circle).

**Figure 9: Bypass Line Assembly**

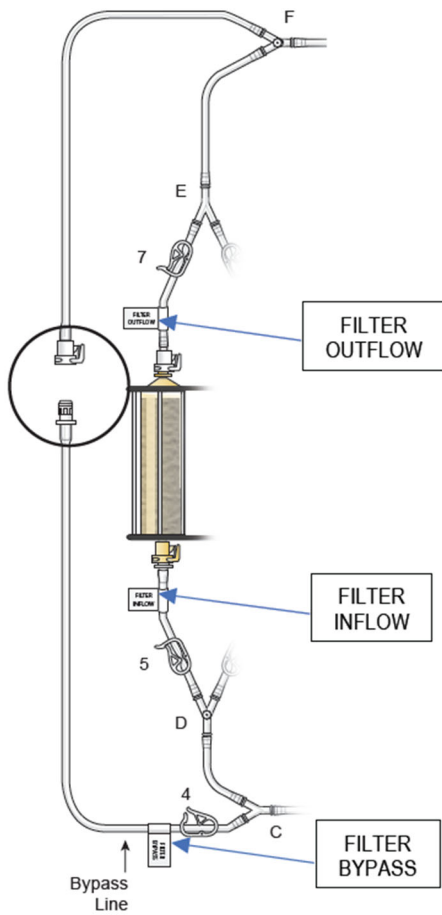

- (k) Remove the "Prime/Flush Line" from its sterile pouch
  - i. Attach the female quick connect on the prime/flush line to the male quick connect coupling of the filter outflow assembly located distal to "Y"-connector at F (Blue Arrow), as shown in **Figure 10**
  - ii. Place the open end of the "Prime/Flush Line" into the basin for collecting the flushed effluent during filter hydration

**Figure 10: Prime Flush Line Assembly Connection**

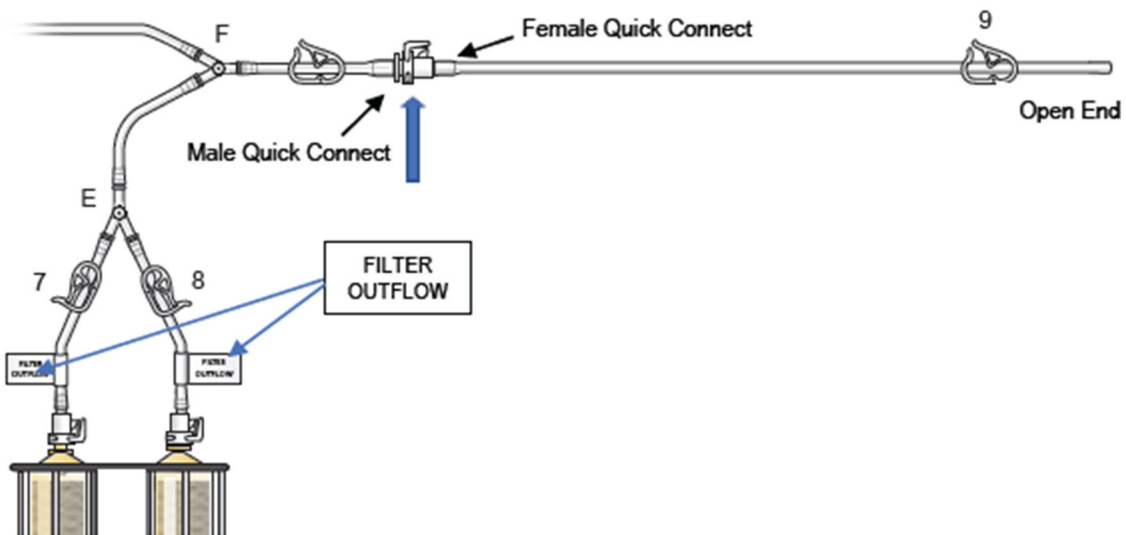

- (l) Attach the supplied stopcocks as outlined in Figure 11 identified by the blue circles to the:
- i. "B" (pre-pump head pressure/suction)
  - ii. "D" (pre-filter pressure)
  - iii. "F" (outlet) Y-connector ports
  - iv. Check that all stopcocks are in the closed position (lever closed to the perfusion circuit)
  - v. Verify "Bypass Line" clamp 4 is open (Blue Arrow)

Figure 11: Stopcock Attachment Locations

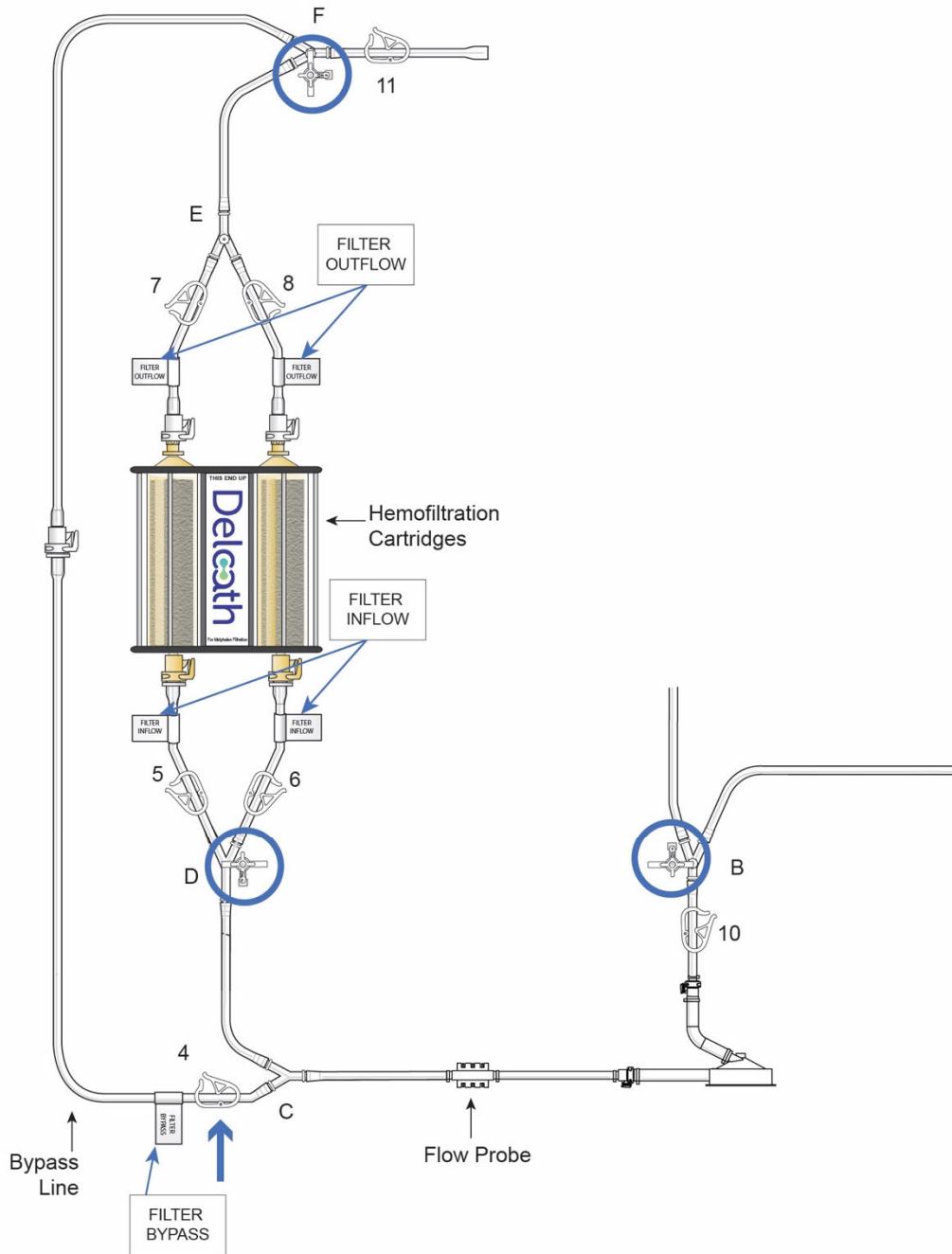

- (m) System CO<sub>2</sub> Prime (see **Figure 12**):
- i. Close outlet clamp (11). Note that clamps 1-10 are open
  - ii. Attach the CO<sub>2</sub> connection line to the stopcock "F" and open the stopcock
  - iii. Connect the open end of the CO<sub>2</sub> connection line to the CO<sub>2</sub> source
  - iv. Set the CO<sub>2</sub> source regulator to 3psi (approximately 3 liters per minute (LPM))
  - v. Start the CO<sub>2</sub> gas flow and allow the CO<sub>2</sub> to flow through the extracorporeal hemofiltration circuit. Note that CO<sub>2</sub> flow is retrograde through the tubing set exiting at IV spikes (clamps 1 & 2) and blue sterile pouch (clamp 3)
  - vi. Adjust CO<sub>2</sub> regulator to maintain 3psi (as necessary). Verify CO<sub>2</sub> flow through the circuit
  - vii. Close bypass clamp (4) after approximately 1 minute to ensure flow through the hemofiltration cartridges
  - viii. Allow CO<sub>2</sub> to flow through the cartridges (after closing clamp 4) for at least 5 minutes but preferably 15 minutes
  - ix. After the desired CO<sub>2</sub> prime duration, close the following clamps to pressurize the system with CO<sub>2</sub> and prevent room air from entering:
    - a. Saline spike clamps (1, 2)
    - b. Double balloon catheter line clamp (3)
    - c. Filter inlet clamps (5, 6)
    - d. Filter outlet clamps (7, 8)
  - x. Stop the CO<sub>2</sub> flow and close the stopcock "F"
  - xi. Disconnect the CO<sub>2</sub> connection line and discard

**Figure 12: CO<sub>2</sub> Priming Connections**

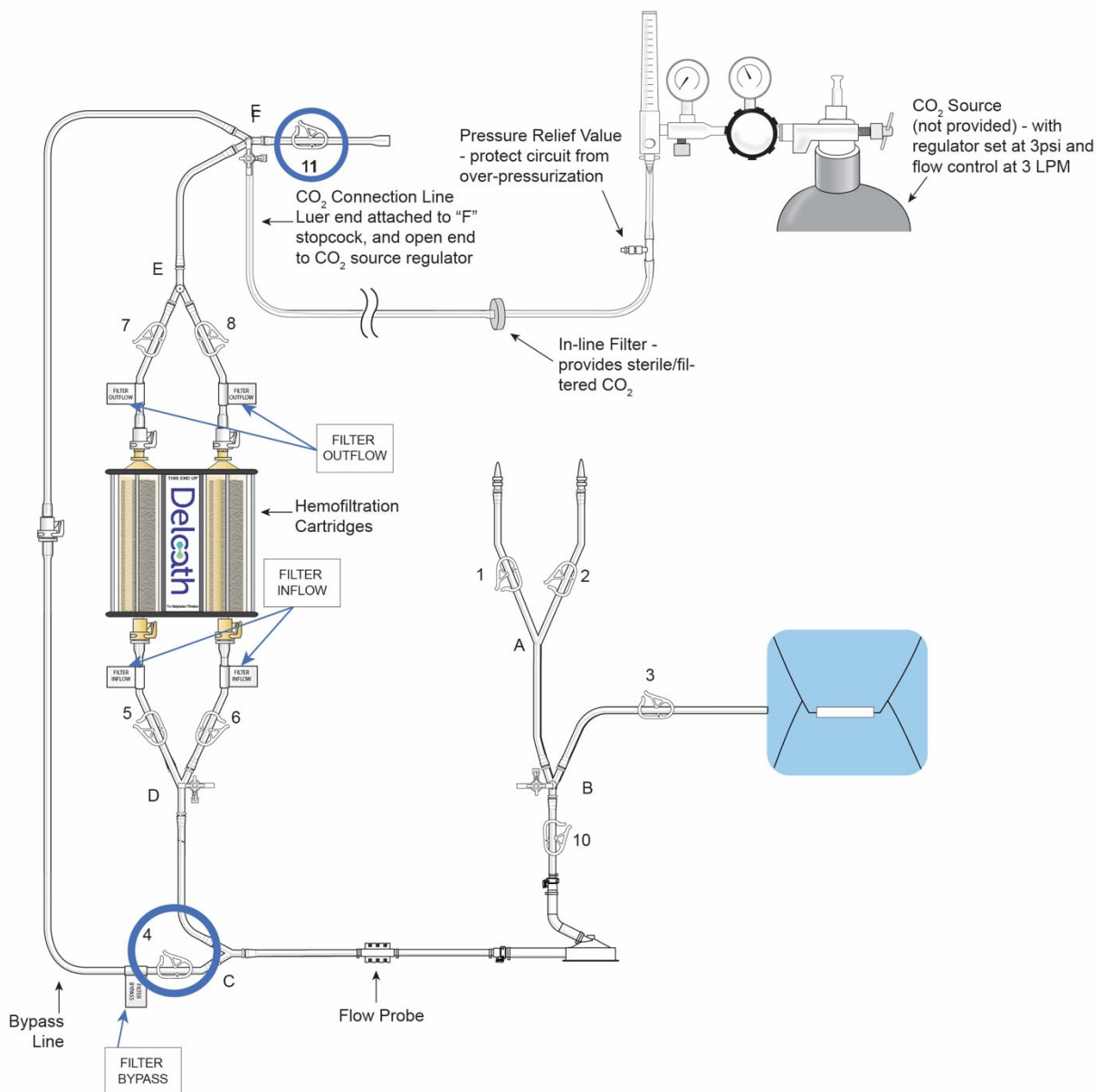

- (n) Hang two bags of the heparinized sterile normal saline and connect to circuit by using the spikes, as shown in **Figure 13**, to allow for gravity priming of circuit components. **CAUTION: Use strict aseptic technique while spiking the heparinized normal saline bags.**

**Figure 13: Connecting Heparinized Saline Bags**

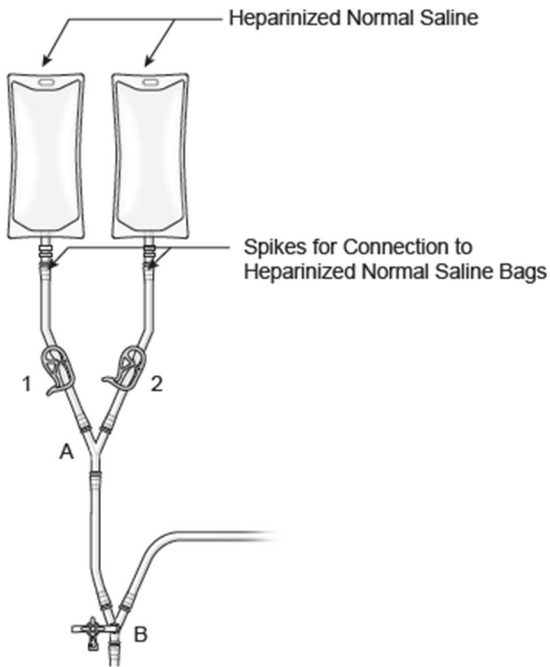

**2. Prime Double Balloon (Isolation Aspiration) Catheter Line**

- Close pre-pump clamp (10).
- Confirm that stopcock "B" is in the closed position (the lever is pointed toward the circuit tubing to the right).
- Open double balloon catheter line clamp (3).
- Open saline line (clamp 1 or 2), to allow heparinized normal saline to prime line only up to clamp 3, see **Figure 14**; blue arrows demonstrating flow direction. **Do not allow excess heparinized normal saline to fill sterile wrap.**
- Close clamp 3.

**Figure 14: Prime Double Balloon Isolation Aspiration Catheter Line**

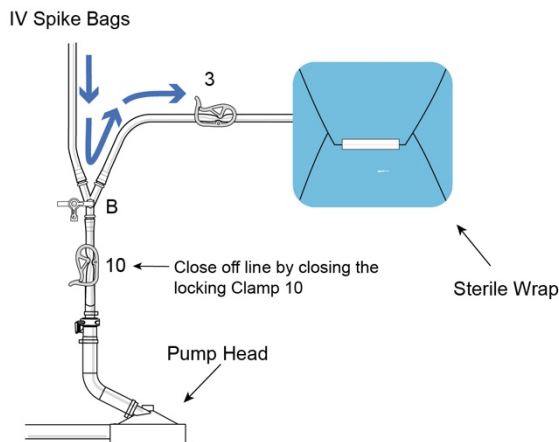

**3. Prime Bypass Line and Pump Head (see **Figure 15**):**

- Inspect that stopcock "D" is in the closed position (the lever is pointed toward the circuit tubing to the left).
- Prime the pump head and bypass lines by opening clamps 10 and 4.
- Close clamp 4.

Figure 15: Priming Bypass Line

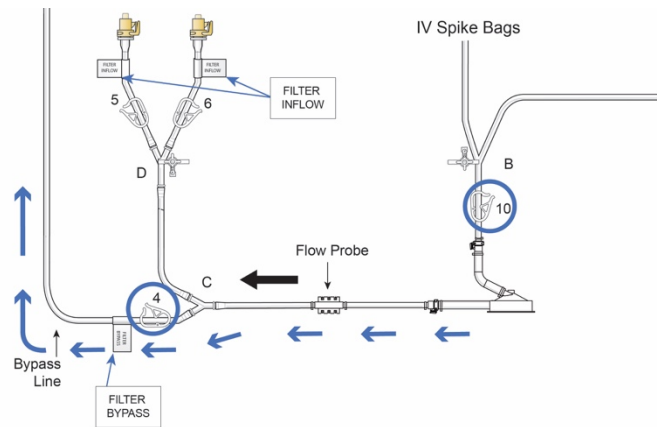

**4. Prime and Flush Dual Filter Cartridge** (see Figure 16 location of clamps and prime flow direction)

**CAUTION: Do NOT allow heparinized normal saline bags to run dry or air will enter the system.**

- (a) Inspect that stopcock "F" is in the closed position (the lever is pointed upward).
- (b) Open filter inlet clamps (5, 6).
- (c) Open filter outlet clamps (7, 8).
- (d) Open circuit outlet clamp (11).
- (e) Adjust the flow of heparinized normal saline into the filter to a rate of approx. 0.5 liters per minute. Note: Hemostats (forceps) are required to adjust flow rate if using gravity.

Figure 16: Priming Filter Cartridges

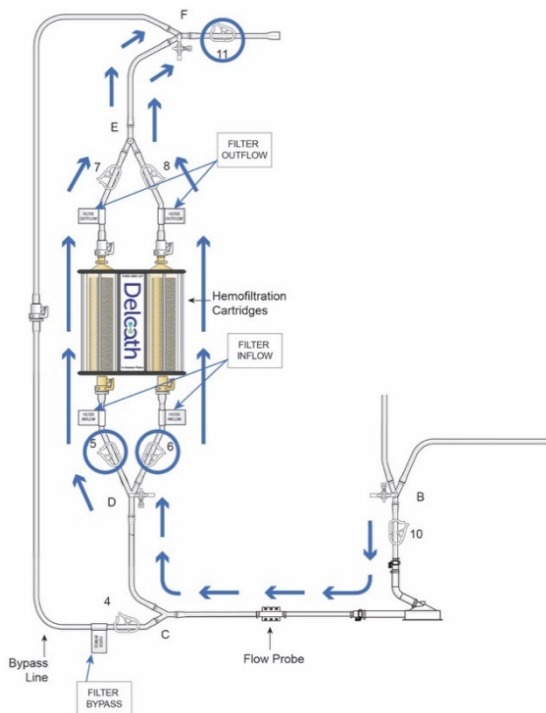

- (f) Note that filter cartridges will have a mottled appearance indicating the presence of gas bubbles.
- (g) Allow heparinized normal saline to flow through the filters and out the "Prime/Flush Line" for approximately 6-10 minutes or until the filter appears gas free (solid black).
- (h) Once all gas appears to have been displaced, gently roll the cartridges between palm of hands to encourage trapped gas bubbles to rise. **CAUTION: Do not use excessive force when rolling the plastic housing.**
- (i) Inspect the entire cartridge for trapped gas by turning the cartridge within housing to visualize the entire filter. If there are gas bubbles gently roll the cartridges to free the trapped gas.
- (j) When Filter Cartridges are gas free, flush with an additional six (6) liters of heparinized normal saline (3 L/cartridge).
- (k) Close filter clamps 5, 6, 7, 8 and outlet clamp 11.



Figure 19: Priming Venous Return Line with Built-In Bubble Trap

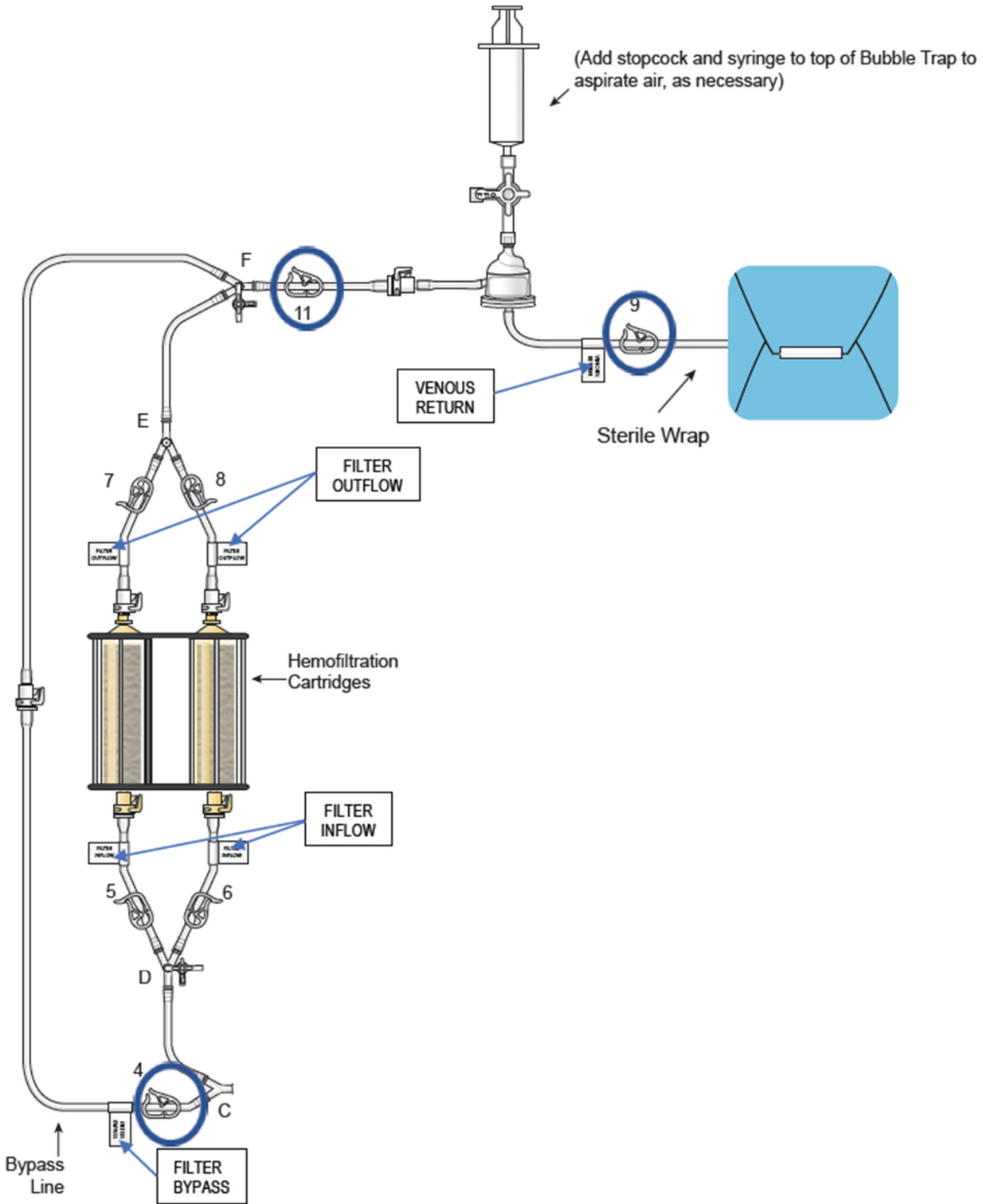

6. **Install Pressure Monitoring Lines**

- (a) Attach pre-pump (to measure negative pressure – pump suction) pressure monitoring line to stopcock “B” and prime, see **Figure 20**.

*Figure 20: Attach and Prime Pre-Pump Pressure Line*

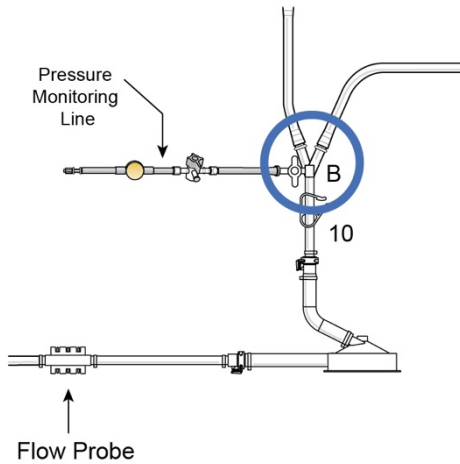

- (b) Attach pre-filter (to measure positive pressure – pre-filter) pressure monitoring line to stopcock “D” and prime, see **Figure 21**.

*Figure 21: Attach and Prime Pre-Filter (Post-Pump) Pressure Line*

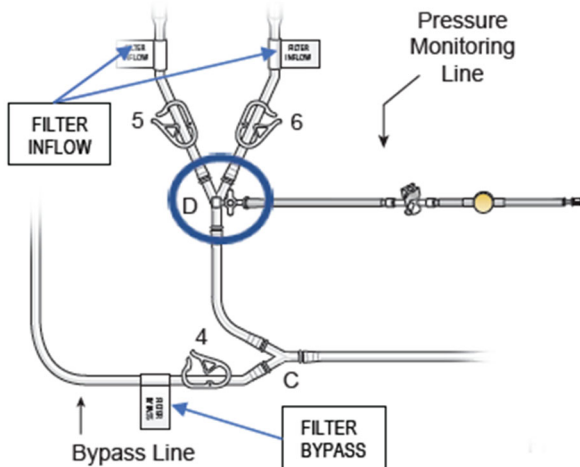

- (c) Attach the pressure monitoring lines to the P1 and P2 ports on the rear of the Medtronic Bio-Console 560 Speed Controller System.  
 (d) Zero the pressure transducers (refer to Medtronic Bio-Console 560 System Manual for details).  
 (e) Coiled pressure monitoring lines are included for use with DLP Pressure Display Boxes, as necessary.

7. **Pressure Test Circuit**

- (a) Pressure test circuit by slowly ramping up the pump head speed (RPM) until a pressure reading of 300 mmHg is achieved on the pressure transducer attached to the line on Y-connector “D” (pre-filter).  
 (b) Visually inspect all connections and cartridges to ensure no leaks are present.

**CAUTION: If leak is noted, ensure connections are secure before proceeding.**

- (c) Turn off pump and close cartridge inlet (5, 6) and outlet (7, 8) clamps. Ensure bypass line clamp (4) is open.  
 (d) System is now primed, hydrated, de-bubbled, and ready for use.  
 (e) Ensure there are two (2) liters of normal saline available for later use.

**WARNING**

Ensure that all air is purged from the system prior to use in order to **avoid an air embolism**

**8. Insertion of the 10F Venous Return Sheath**

- (a) Attach the stopcock to the sheath side port tube.
- (b) Using standard Seldinger technique (recommended ultrasound guidance), insert the venous return sheath, into the internal jugular vein (preferably the right side internal jugular vein, see **Figure 22**). Use of sonographic guidance and a single anterior wall puncture of the vein is recommended to avoid inadvertent carotid artery puncture. If carotid artery puncture occurs, the procedure must be aborted and postponed to a later date, due to hemorrhage risk with high level of anticoagulation.
- (c) Flush the sheath with sterile heparinized normal saline.
- (d) Close the stopcock.

*Figure 22: Placing Venous Return Sheath into Internal Jugular Vein*

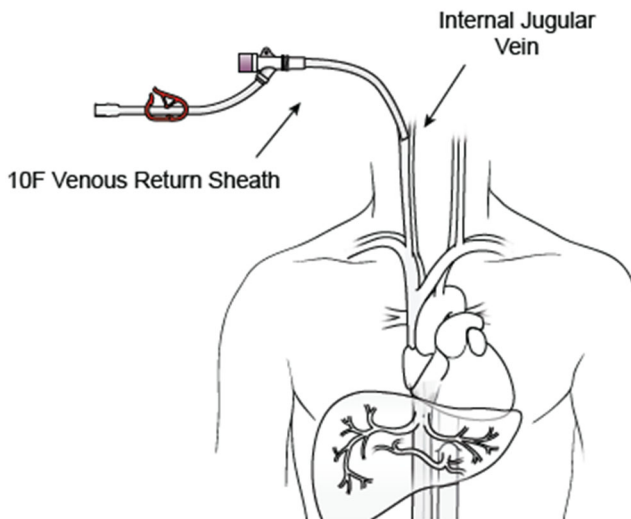

**9. Insertion of the 5F Femoral Arterial Sheath**

- (a) Using Seldinger puncture technique and standard fluoroscopic and arteriographic techniques, place the 5F Introducer Sheath into the femoral artery, see **Figure 23**.
- (b) Recommend sonographic guidance and a single anterior wall puncture of the femoral artery over the femoral head to assure compressibility of the artery when the sheath is removed. If a supra-inguinal puncture is made, the procedure must be aborted and postponed to a later date.

*Figure 23: Placing Femoral Artery Sheath*

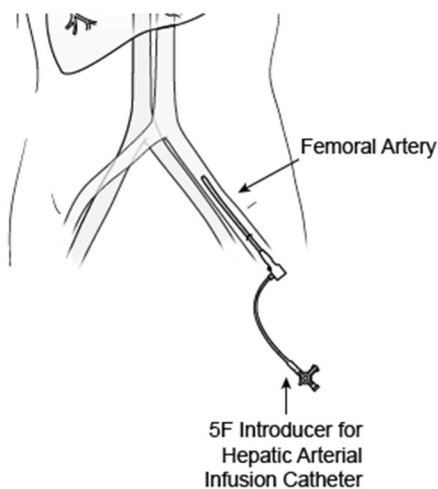

**10. Insertion of the 18F Venous Sheath**

- (a) Using Seldinger technique and standard fluoroscopic and angiographic techniques, place the 18F introducer sheath into the femoral vein after serial dilation with 9F and 13F dilators. The venous sheath may be placed ipsilateral or contralateral to the 5F femoral arterial sheath placement, see **Figure 24**.
- (b) Flush the sheath with sterile heparinized normal saline.
- (c) Recommend use of sonographic guidance and a single anterior wall puncture of the femoral vein over the femoral head to assure compressibility of the vein when the sheath is removed. If a supra-inguinal puncture is inadvertently made, the procedure must be aborted and postponed to a later date.

Figure 24: Placing Femoral Venous Sheath

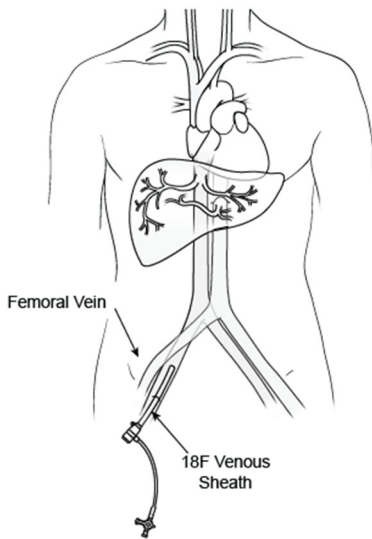

11. **Insertion of 5F Infusion Catheter**

- (a) Introduce the 5F Infusion catheter through the sheath and manipulate it over a guidewire into the proper hepatic artery, see **Figure 25**. At the discretion of the Interventional Radiologist, a microcatheter may be coaxially introduced through the 5F catheter for selective catheter tip placement for drug infusion. If a microcatheter is used, attach a rotating hemostatic valve (Touhy-Borst type) to the 5F catheter and insert the microcatheter into the 5F catheter through the valve. Three microcatheters have been qualified by Delcath for use with the HEPZATO for Injection/Hepatic Delivery System. Select one of the three microcatheters qualified (see [Description of System Components](#) (pg. 5)).

**WARNING**

To deliver melphalan to the whole liver and avoid inadvertent infusion of melphalan into the gastrointestinal or visceral branches, conduct a thorough hepatic artery angiogram and investigation of variant hepatic and gastric artery anatomy. In addition, embolization of certain branches supplying the gastro-intestinal tract may be necessary.

The catheter must be positioned as described below so that **drug is infused ONLY into the liver**. Perfusion of drug into any other abdominal organ or gastrointestinal branches must be avoided as this may result in serious injury or death.

- (b) Position the infusion catheter (5F catheter or microcatheter) in the hepatic artery for intra hepatic HEPZATO administration and to exclude HEPZATO delivery into extrahepatic gastric side branches either directly or in the case of reflux. Affix the 5F catheter to the skin at the groin.
- (c) Connect the infusion catheter (5F catheter or microcatheter) to the drug delivery system (see [step 18](#)) and maintain catheter patency by hospital catheter infusion protocols (e.g., infuse heparinized normal saline: The concentration of heparin should be 1,000 units per 500 mL of normal saline).

Figure 25: Insertion of Hepatic Artery Infusion Catheter

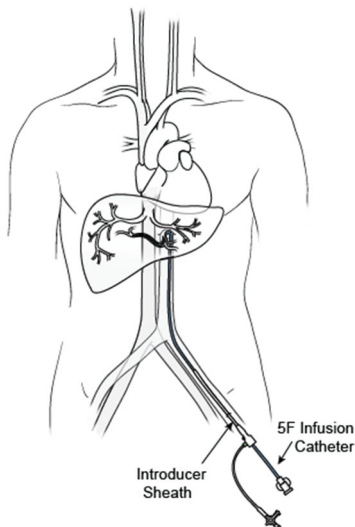

**ESTABLISHING ANTICOAGULATION & PLACING DOUBLE BALLOON CATHETER**

PF	DD	IR
----	----	----

**12. Anticoagulation**

- (a) DO NOT place the double balloon catheter until the patient is fully anticoagulated.
- (b) DO NOT administer heparin until the placements of all vascular sheaths.
- (c) Obtain the baseline activated clotting time value.
- (d) Administer heparin.
- (e) Administer an initial intravenous bolus of 300 units/kg of heparin. Heparin dose should be adjusted to achieve a minimum activated clotting time of 400 seconds prior to initiation of veno-venous bypass and balloon inflation.
- (f) Evaluate activated clotting time frequently (approximately every 5 minutes) until adequate anti-coagulation is established (activated clotting time > 400 seconds). Maintain activated clotting time at > 400 seconds (preferably > 450 seconds) throughout the procedure, obtaining ACT values every 15-30 minutes depending on the patient’s response, and administering intravenous heparin as needed.

**WARNING**  
The start of the intra-arterial infusion of the drug solution must be within 30 minutes of its preparation.

**NOTE: TIMING OF CHEMOTHERAPEUTIC AGENT DELIVERY**

Time the request for delivery of the chemotherapeutic agent (HEPZATO) so that the start of the intra-arterial infusion of the drug solution is within thirty minutes of its preparation. Since preparation and delivery times vary, depending upon local practices, the timing of the request is critical and should be pre-arranged with the pharmacist. Ideally, the time to request chemotherapeutic agent from the pharmacy would be when the patient is heparinized just prior to placing the Double Balloon Catheter.

**13. Insertion of the Double Balloon Catheter**

- (a) Flush the **Double Balloon** catheter with heparinized normal saline.
- (b) Introduce the **Double Balloon** catheter through the 18F sheath. Under fluoroscopic guidance advance it over a guidewire into the inferior vena cava and position the catheter tip at the level of diaphragmatic hiatus. Do NOT expand the balloons.
- (c) Upon successful placement, remove guidewire and create a heparin lock within the “OTW” lumen to maintain patency.

**CONNECTING CATHETERS TO EXTRACORPOREAL HEMOFILTRATION CIRCUIT**

IR	PF
----	----

**14. Connection of Catheter to Extracorporeal Hemofiltration Circuit**

- (a) Remove sterile wrap from extracorporeal hemofiltration circuit double balloon catheter line while maintaining sterility and transfer sterile end to interventional radiologist.
- (b) Open saline line (clamp 1 or 2) clamp and clamp 3 to allow for a “wet connection” of the extracorporeal hemofiltration circuit to the double balloon catheter large drainage lumen with a quick connect fitting, see **Figure 26**. After connection is made, close saline line clamp (clamp 1 or 2, same ones opened previously). Ensure that all air is removed from the double balloon catheter.

*Figure 26: Connecting Double Balloon Catheter to Circuit*

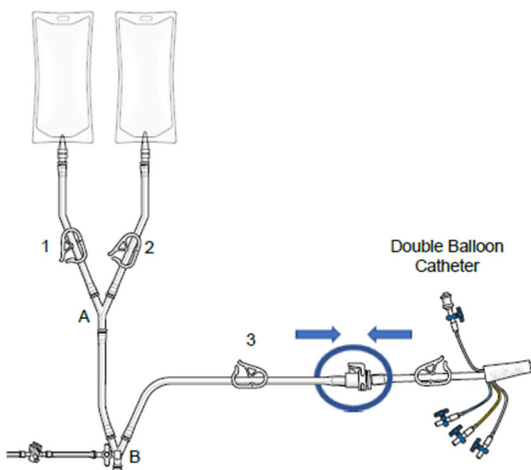

- (c) Remove the sterile wrap from the extracorporeal hemofiltration circuit venous return line while maintaining sterility and transfer sterile end to the interventional radiologist and flush normal saline to fill the line.
- (d) Connect the extracorporeal hemofiltration circuit venous return line to the stopcock of the 10F venous return sheath placed in the jugular vein (Venous Return Sheath tubing has a red clamp), flush normal saline through the line. When all air is removed, and line is completely filled with normal saline turn stopcock to close the side port. Ensure the stopcock (at the venous return line to sheath connection) is fully open to minimize back pressure and maximize flow through the stopcock. (“OFF” handle of stopcock turned 90° to flow path.)

15. **Establishing Hemofiltration Circulation**

- (a) Confirm filter inlet and outlet clamps are CLOSED (5, 6, 7 and 8) (red circles), per **Figure 27**.
- (b) Open clamp 9 (blue circles).
- (c) Confirm that clamps 3, 4, 10 and 11 are open (blue circles)
- (d) Start pump and slowly increase RPM control to achieve a maximum allowable flow rate which does not cause flow induced vibration or exceed the 0.80 L/min flow rate or -250 mmHg pre-pump pressure.
  - Flow rates of approximately 0.40 to 0.60 liters/minute are typical: **0.40 L/min** is the minimum allowable and **0.80 L/min** is the maximum allowable flow rate for this system.
  - In-line pressure transducers should be used to monitor pressures:
    - Pre pump pressure (suction side) should not be more negative than **-250 mmHg**, as lower pressures indicate possible catheter collapse or kink.
    - Pre-cartridge pressures (pre-filter) should not exceed **200 mmHg**, as higher pressures indicate increasing filter resistance potentially due to thrombus or a kinked return line. Check filters to assure free flow and return line for kinks.
- (e) The extracorporeal hemofiltration circuit is now established. Venous blood is aspirated from the central lumen through the fenestrations in the **Double Balloon** catheter. This blood flows through the **Double Balloon** catheter to the pump, through the bypass line, and returns to the patient through the venous return sheath.

**CAUTION: Continuously monitor any perfusion related events including:**

- Blood flowrate as displayed by the Medtronic Bio-Console
- Systolic, diastolic and mean arterial blood pressure
- Heart rate and vital signs
- Activated clotting times
- Bubble-trap for entrapped air
- Leaks from any part of the circuit

*Figure 27: Establishing Hemofiltration Circulation*

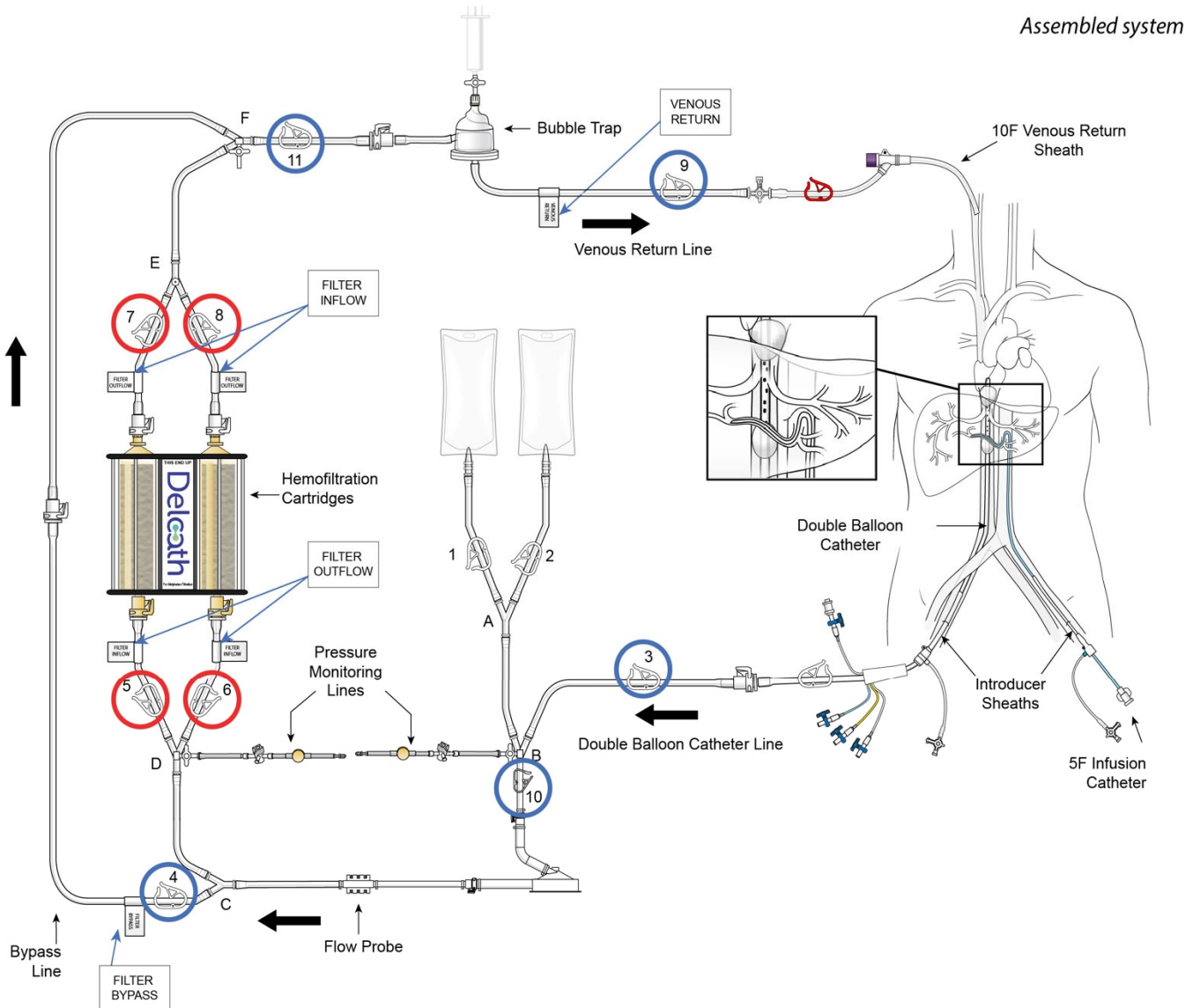

ISOLATING THE INFERIOR VENA CAVA



16. Expansion of Balloons

**WARNING**

There is an anticipated significant decrease of blood pressure following the initial occlusion of the inferior vena cava by the balloons. **It is critical to maintain mean blood pressure above 65 mmHg**

Vasoactive Agents Response Testing: Prior to expansion of either balloon (occlusion of inferior vena cava), administer vasoactive agent to assess patient responsiveness to this agent. It is recommended to use an infusion pump to quantify vasopressor doses during each procedural period. After balloons expansion, assess patient blood pressure for two (2) to five (5) minutes before proceeding. Significant decreases in blood pressure will occur within two (2) to five (5) minutes.

Continue to administer vasoactive agents to maintain mean blood pressures above 65 mmHg. Vasopressor agents are typically not required after the conclusion of the procedure.

- (a) Perfusionist must carefully monitor the flow rate during the balloon expansion.

**WARNING**

Do NOT Over Expand the Balloons. Over Expansion of the Balloons Could Cause the Balloons to Burst which could result in Life-Threatening Injury.

- (b) Maximum balloon expansion volumes:
  - Cephalad Balloon: **38 mL** of dilute contrast medium
  - Caudal Balloon: **38 mL** of dilute contrast medium
- (c) Under fluoroscopy, partially expand the cephalad balloon with approximately 15 - 25 mL of dilute contrast media (e.g., 35% dilution) within the right atrium (the balloon will have a rounded appearance).
- (d) With the caudal balloon collapsed, slowly retract the **Double Balloon** catheter until the cephalad balloon is at the junction of the right atrium and inferior vena cava. If needed, further expand the cephalad balloon until indentation of the diaphragmatic hiatus is visible at the inferior margin (the balloon will acquire an acorn shaped appearance, see **Figure 28**). Do not expand balloons beyond required volume to achieve an adequate seal. Never advance or retract the **Double Balloon** catheter when both balloons are expanded. If resistance is met during manipulation, determine the cause of the resistance before proceeding.

*Figure 28: Expansion and Placement of Cephalad Balloon*

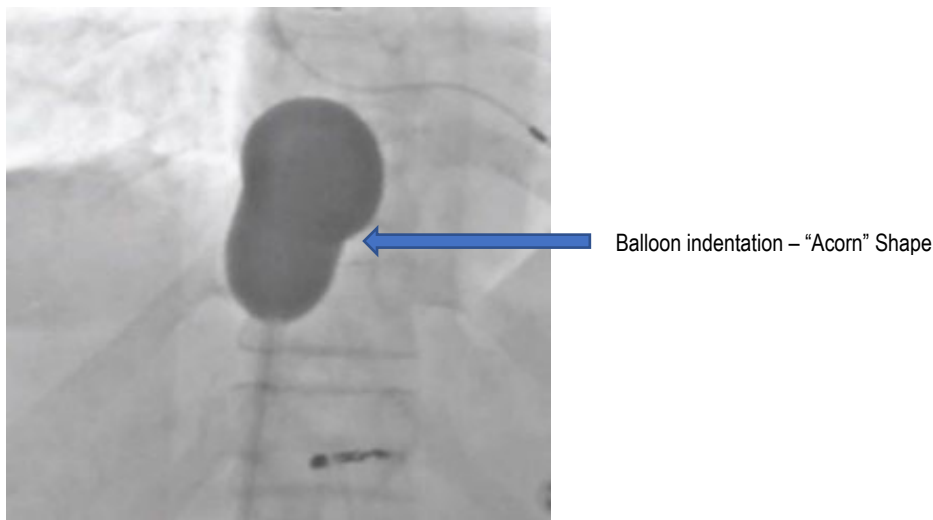

- (e) Under fluoroscopy, expand the caudal balloon with dilute contrast medium until the lateral edges of the expanded balloon start to become effaced by the inferior vena cava wall.

**WARNING**

Never stop blood flow through the extracorporeal hemofiltration circuit for more than 30 seconds.

- (f) With balloons expanded, perform a limited (retro-hepatic) inferior vena cavagram (using digital subtraction angiography technique) through the fenestrations. Prior to injection of contrast medium, reduce the pump speed to 1,000 RPM and clamp off the circuit. Inject iodinated contrast medium through the CONTRAST port to confirm that the catheter properly isolates hepatic venous flow between the balloons. The cephalad balloon must occlude the inferior vena cava just above the highest (closest to right atrium) hepatic vein, and the caudal balloon must occlude the inferior vena cava just below the lowest hepatic vein (above the renal veins) as shown in the radiographic image in **Figure 29**.
- (g) Re-establish flow through the extracorporeal hemofiltration circuit by unclamping the circuit and returning pump RPM to deliver previous flow rate.

*Figure 29: Confirming Hepatic Venous Isolation*



**WARNING**

Never Adjust the Position of the Double Balloon Catheter Unless Both Balloons are Fully Collapsed

- (h) If the **Double Balloon** catheter is not in the proper position, collapse both balloons (caudal balloon first) and then reposition the catheter, while maintaining flow in the extracorporeal hemofiltration circuit.
- (i) Once satisfactory position is attained (i.e., the isolated segment is well sealed), gently hold the proximal end of the **Double Balloon** catheter to prevent upward migration of the catheter into the right atrium. The catheter must be held due to forces that will push the balloon upwards towards the right atrium, and its position checked for the duration of the procedure (approximately 60 minutes).

**CAUTION:** Check **Double Balloon** catheter balloon positions fluoroscopically every four (4) to five (5) minutes during drug administration and filtration to ensure continued hepatic venous isolation.

17. **Bringing Hemofiltration Cartridges online**

- (a) HEPZATO preparation should be in the procedure room prior to bringing filters online. This reduces filter related complications and occupation of melphalan binding sites by blood components.
- (b) Continuously monitor and check the patient’s blood pressure as required (see “Blood Pressure Control”).
- (c) Typically, each filter is brought online sequentially while leaving the bypass line open.
- (d) Bring the left cartridge online by opening clamps 5 and 7 (see blue circles) allowing blood to displace the heparinized normal saline into the patient.
- (e) Observe and manage blood pressure.
- (f) After the heparinized normal saline in the left cartridge and its lines is fully replaced with blood, wait approximately 30 seconds and open right cartridge clamps 6 and 8 (see green circles), while keeping the bypass line open.
- (g) Once the heparinized normal saline in the right cartridge and its lines is fully replaced with blood, wait approximately 30 seconds managing blood pressure.
- (h) Once blood pressure is stable close the bypass line by **securely closing clamp 4 (red circle)**, see Figure 30. Add a reusable tube clamp as a redundant bypass closure mechanism high on the bypass line in clear view of the team.
- (i) Manage and stabilize blood pressure.

Figure 30: Bringing Hemofiltration Cartridges online

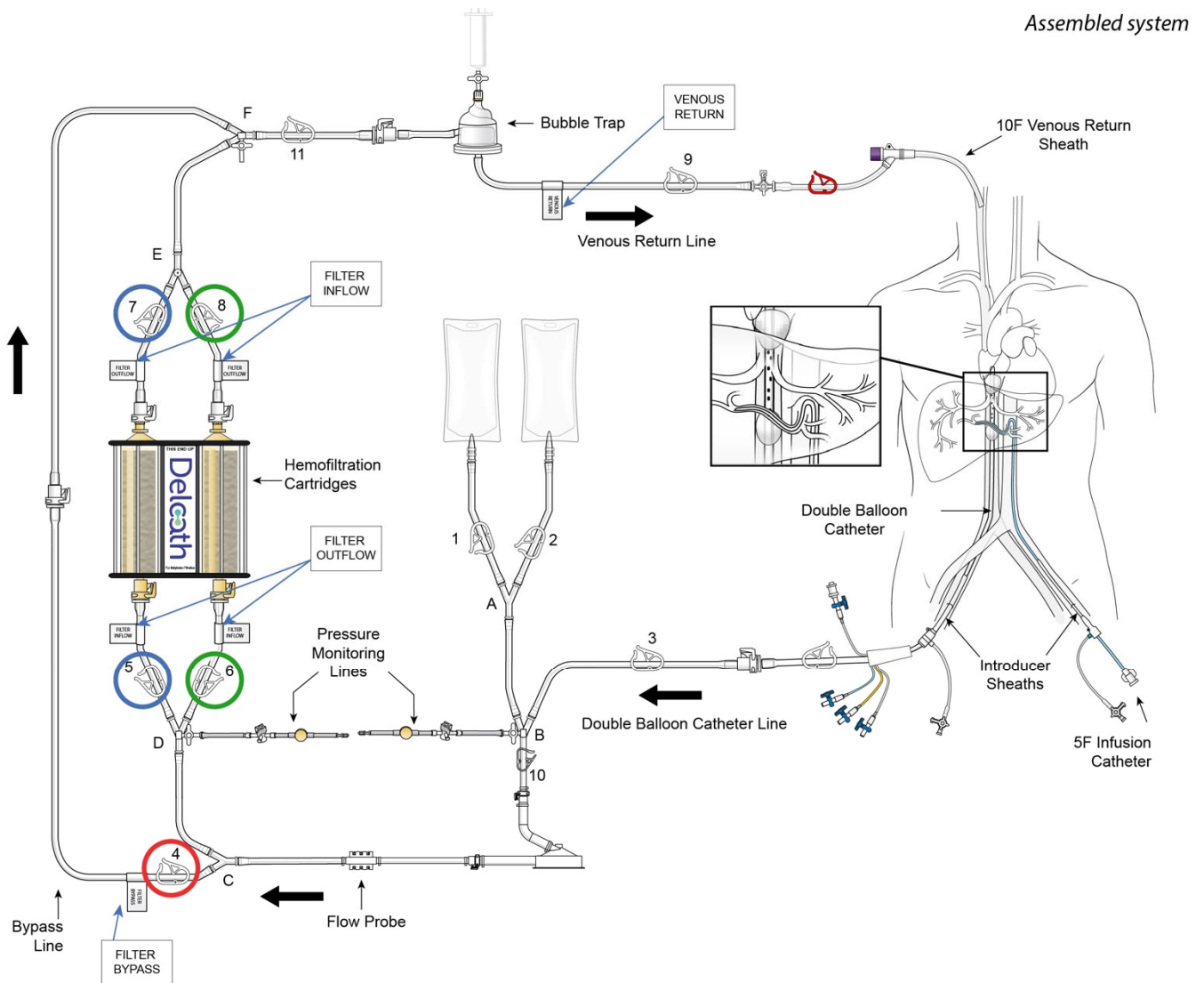

**WARNING**

Close bypass line prior to infusion of drug. Never reopen bypass line

**18. Drug Administration and Extracorporeal Filtration**

HEPZATO is prepared by Pharmacy per physician’s prescription. Reconstitute each melphalan vial with 10 mL of supplied diluent.

- For doses up to 110 mg, dilute reconstituted HEPZATO in 250 mL 0.9% Sodium Chloride Injection (use one (1) 250 mL bag provided).
- For doses between 111 mg and 220 mg, divide the total dose equally into 2 and dilute each in 250 mL 0.9% Sodium Chloride Injection (total volume of 500ml using the two (2) 250 mL bags provided).

Multiple injection cycles of the diluted HEPZATO solution will be required (see delivery parameters described below).

**WARNING**

The start of the intra-arterial infusion of the drug solution must be within 30 minutes of its preparation in the pharmacy.  
The duration of time between filters brought online and start of HEPZATO administration should be minimized on the order of < 5 minutes

- To deliver the drug solution, divide total volume into volumes within the capacity of the injector syringe.
- Deliver drug solution at a flow rate of 25mL/min. Refill syringe after each injection cycle.
- Conduct spasm check of the hepatic arteries and confirm balloon position and expansion against vena cava walls by fluoroscopy while refilling syringe.
- Continue infusion until all drug is delivered within 30 minutes. Below are the delivery parameters:
  - Total volume of 500 mL – 5 infusions of 100 mL at 25mL/min
  - Total volume of 540 mL – 5 infusions of 100 mL + infusion of 40 mL at 25mL/min
  - Total volume of 250 mL – 2 infusions of 100 mL + infusion of 50 mL at 25 mL/min
  - Total volume of 270 mL – 2 infusions of 100 mL + infusion of 70 mL at 25 mL/min

- (a) Set-up drug delivery system by installing a 150 mL syringe into the drug injector and setting the injector flow rate to 25 mL/minute and enter the injection volume determined as described above. See **Figure 31** for HEPZATO administration set up.
- (b) Attach intravenous fluid administration sets to the other ports of the two stopcocks, as shown in **Figure 31**.

Figure 31: HEPZATO Administration System Setup

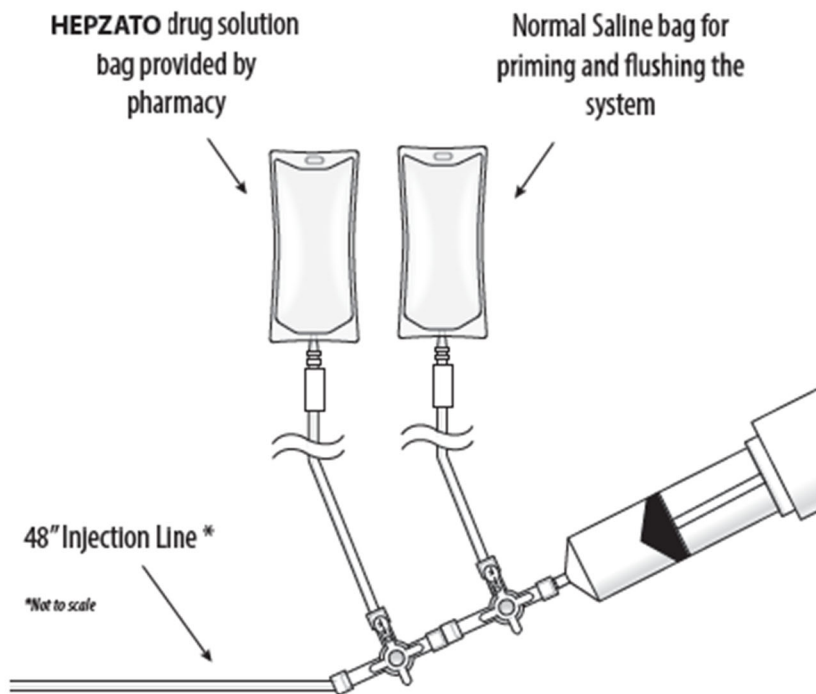

- (c) Prepare, label, and connect three (3) syringes: One (1) for contrast, one (1) for intra-arterial nitroglycerin (IANTG), and one (1) for normal saline. An example setup is depicted in **Figure 32**.
- Undiluted iodinated contrast agent is for checking hepatic artery spasm via CT. The contrast is injected by hand via the syringe for the arteriogram.
  - Nitroglycerin is prepared for use, as needed, to relieve hepatic artery spasm.
  - Normal saline is drawn into the saline syringe for priming and flushing the hepatic arterial infusion line during the procedure.

**Figure 32: Manifold Setup of for Nitroglycerin, Contrast and Saline**

Syringes filled with Normal Saline for flushing between Contrast Injections to perform vessel spasm checks and administer IANTG

Recommendation: Use two stopcocks. Keep NTG syringe on back table. Replace saline syringe when NTG dose is required then remove NTG syringe and replace with saline flush. This will reduce the chance for inadvertent NTG administration.

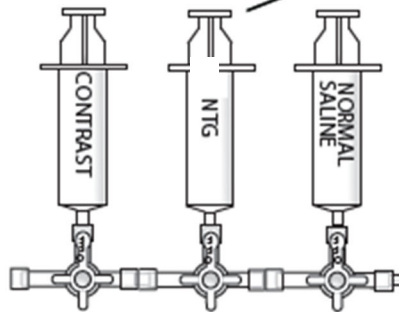

Draw the following volumes and concentrations of contrast, nitroglycerin, and normal saline into the three syringes of the drug delivery set-up.

Syringe	Volume and Concentration to Prepare in Syringe
Contrast	Use institutional practices for microcatheter contrast delivery
NTG	Use institutional practices
Normal Saline	20 mL of 0.9% Sodium Chloride Injection

- (d) Hang a 500 mL bag of normal saline and the chemotherapeutic agent (melphalan hydrochloride) drug solution bag on the intravenous pole and ensure the roller clamps are closed, and spike the bags, as shown in **Figure 33**. Visually inspect the solution for particulates. If particulates are observed, DO NOT USE.

**Figure 33: HEPZATO Administration System Setup**

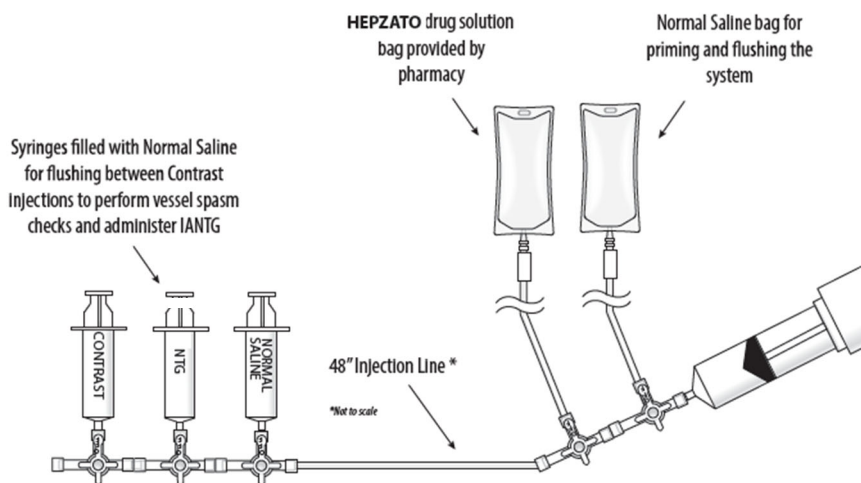

- (e) Prime the drug delivery system with normal saline, fill injector syringe with approximately 120 mL of diluted drug. Ensure all air is purged from the system.

- (f) When the extracorporeal hemofiltration circuit is running satisfactorily and the patient is hemodynamic stable, flush the hepatic arterial infusion line with normal saline to avoid directly mixing heparin with chemotherapeutic agent (melphalan hydrochloride). Connect drug infusion line to Hepatic Artery Infusion catheter (5F Catheter or microcatheter) to complete the drug delivery circuit.
- (g) Perform an arteriogram to assess patency of the hepatic artery. Use undiluted iodinated contrast agent to check for hepatic artery spasm via CT. The contrast is injected by hand via the syringe for the arteriogram. In circumstances where hepatic arterial spasm is noted, administer nitroglycerin intra-arterially to alleviate the spasm. Always flush the injection line with normal saline after contrast injections.

**WARNING**

Assess arterial patency approximately every four (4) to five (5) minutes via contrast administration during drug infusion. Administer intra-arterial nitroglycerin if arterial spasm is noted. If spasm cannot be relieved, terminate the procedure (see ending extracorporeal circulation below).

- (h) Initiate administration of the 1<sup>st</sup> dose of chemotherapeutic agent (melphalan hydrochloride) through the Infusion catheter.

**WARNING**

Immediately stop the procedure if perfusion of drug is detected outside of the isolated region and cannot be corrected. Once the infusion of chemotherapeutic agent (melphalan hydrochloride) has started, do not collapse balloons unless administration of drug has been stopped and a full washout cycle (30 minutes) has been completed.

- (i) After the prescribed dose has been fully administered, continue extracorporeal filtration for an additional 30 minutes (washout period).

**ENDING EXTRACORPOREAL CIRCULATION**

IR

PF

**19. Ending Extracorporeal Circulation**

- (a) At the end of the 30-minute wash-out period, collapse the caudal balloon fully.
- (b) Then collapse the cephalad balloon fully.
- (c) Discontinue filtration by:
  - i. Reducing the pump RPM to 1,000,
  - ii. Closing clamps 3 and 9 See **Figure 34 (red circles)**.
  - iii. Stop flow by turning off the pump.

*Figure 34: Close Circuit Inflow and Circuit Return Clamps to Discontinue Extracorporeal Circulation*

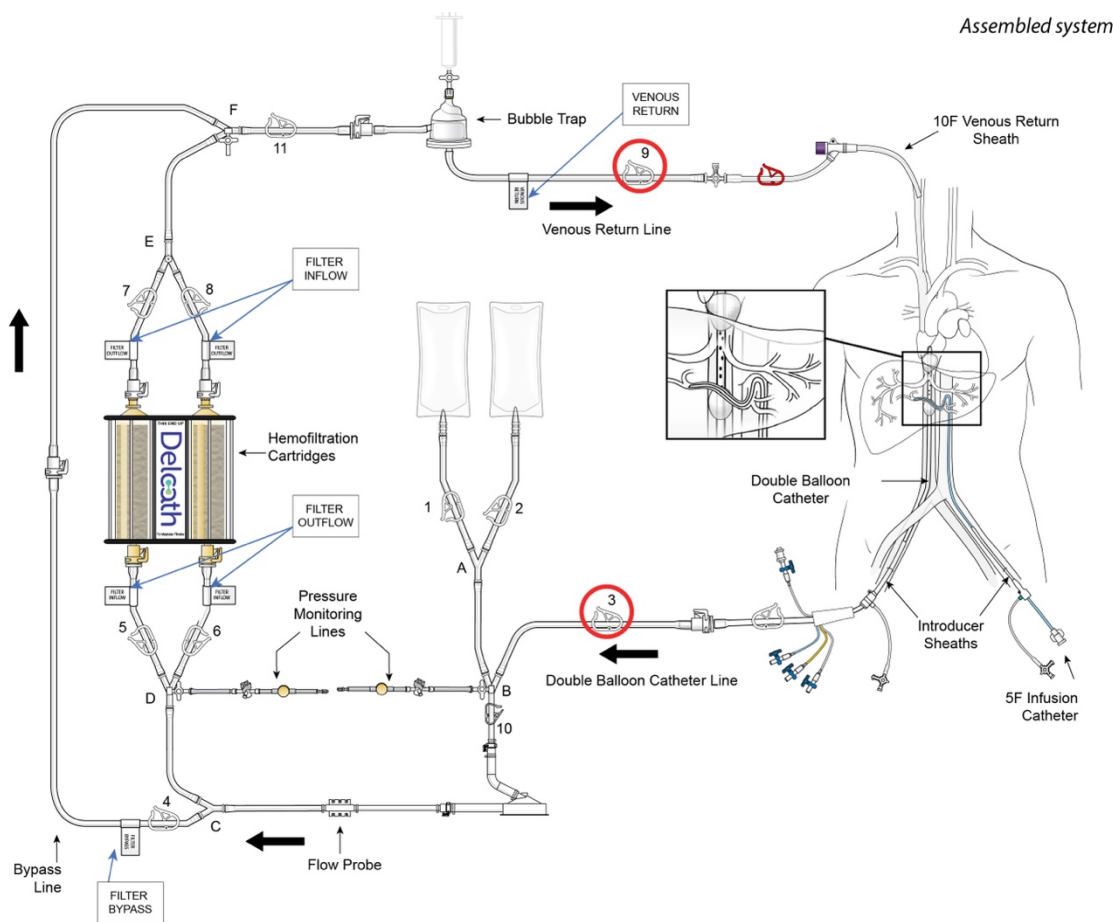

CATHETER REMOVAL IR

20. **Catheter Removal**

- (a) When melphalan infusion is completed remove the guide catheter and infusion microcatheter from femoral artery access. **The 5F arterial sheath should only be removed when coagulation status has been normalized.**
- (b) When washout phase is completed remove **Double Balloon** catheter from the femoral vein access and replace with 18F obturator. Place the obturator completely into the sheath so the obturator hub bottoms out onto the sheath hub. **The 18F venous sheath should only be removed when coagulation status has been normalized.**
- (c) Close the stopcock or red clamp on the 10F venous return sheath side port and disconnect the venous return line from the sheath. **Do not remove the 10F venous return sheath until coagulation status has been normalized.**
- (d) Dispose of all components appropriately in accordance with hospital, local, state, and federal biohazard guidelines.

**NORMALIZATION OF COAGULATION STATUS FOR SHEATH REMOVAL** O IR IN

21. **Normalization of Coagulation Status for Sheath Removal**

- (a) Administer protamine sulfate by slow intravenous infusion in a dose appropriate to the amount of heparin given and the activated clotting time.
- (b) Administer 10 units of cryoprecipitate and/or Fresh Frozen Plasma based on coagulation profiles to correct remaining abnormalities, if indicated, per institutional guidelines.
- (c) Repeat coagulation profile.
- (d) Correct remaining coagulopathy following institutional guidelines. The following recommendations are provided for consideration:

Coagulation Profile	Action
Prothrombin time greater than 2 seconds of normal	Administer Fresh Frozen Plasma
Partial thromboplastin time greater than 5 seconds of normal	Administer protamine

- (e) Measure blood platelet levels to determine if replacement is needed.
- (f) Follow institutional guidelines for administration of packed red blood cells for anemia.
- (g) All sheaths may be removed if the platelet count is greater than 50,000/ mm<sup>3</sup> and after the patient's coagulation status has normalized. Compress puncture sites until adequate hemostasis is achieved.
- (h) Dispose of all components appropriately in accordance with hospital, local, state, and federal biohazard guidelines.
- (i) Carefully monitor the patient until complete recovery.

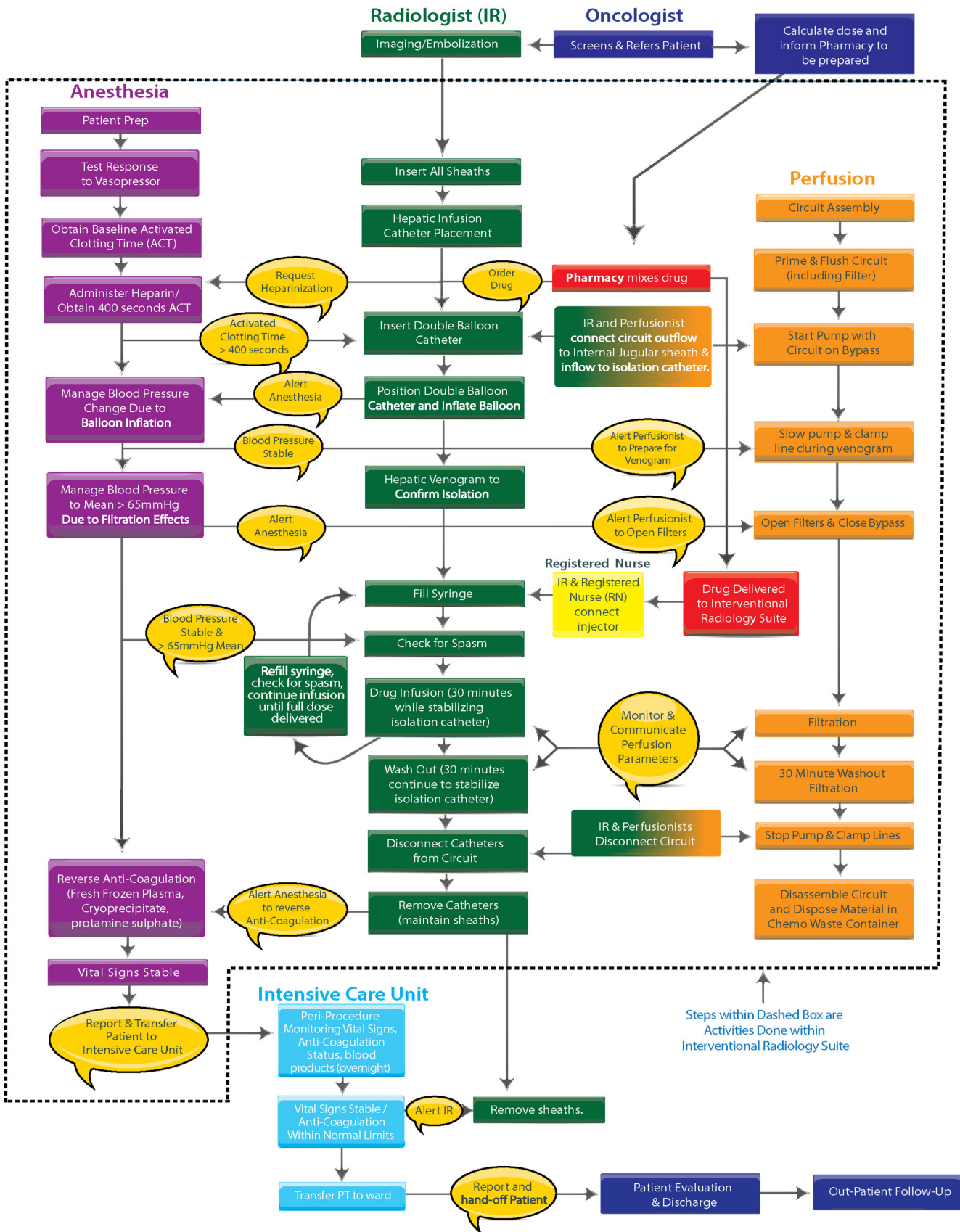

PROCEDURE FLOWCHART - FIGURE 35



Manufactured by:  
**Delcath Systems, Inc.**  
Queensbury, NY 12804

Delcath is a registered trademark of Delcath Systems, Inc.  
HEPZATO is a registered trademark of Delcath Systems, Inc.  
HEPZATO KIT is a registered trademark of Delcath Systems, Inc.  
© 2023 Delcath Systems, Inc. All rights reserved.

Medtronic's Bio-Console<sup>®</sup>, Bio-Pump, and Bio-Probe are registered trademarks of Medtronic Inc.



**Recyclable  
Package**

# Delcath®

## Hepatic Delivery System

For use with **HEPZATO™**  
(melphalan) for Injection

<b>REF</b>  <b>420032</b>	<b>EXP: YYYY-MM-DD</b>
	<b>LOT: XXXXXXXX</b>

**Contents:**

**1 - Hemofiltration Circuit**

**Consult the HEPZATO KIT™ Instructions for Use prior to use.**



420032XXXXXXXXXXYYYYMMDD

Manufactured by:  
**Delcath Systems, Inc.**  
Queensbury, NY 12804

10074.A

# Delcath<sup>®</sup>

## Hepatic Delivery System

For use with **HEPZATO<sup>™</sup>**  
(melphalan) for Injection

REF	600003	EXP: YYYY-MM-DD
		LOT: XXXXXXXX

**Contents:**

- 1 - Double Balloon Catheter (50 mm Balloon Spacing)
- 1 - 5F Infusion Catheter - Cobra 2 (CB2) Tip
- 1 - Dual Hemofiltration Cartridge
- 1 - Hemofiltration Circuit
- 1 - CO<sub>2</sub> Connection Line
- 1 - 10F Introducer Set (Venous Return Sheath)
- 1 - 5F Introducer Set
- 1 - 9F and 13F Dilator Set
- 1 - 18F Introducer Set
- 1 - 18F Obturator

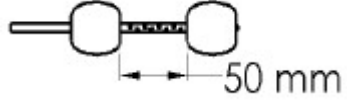

**Caution: This Double Balloon Catheter Contains Natural Rubber Latex Which May Cause Allergic Reactions.**

Consult the HEPZATO KIT<sup>™</sup> Instructions for Use prior to use.

REF 600003  
  
600003XXXXXXXXXXYYMMDD  
 EXP: YYYY-MM-DD LOT: XXXXXXXX

REF 600003  
  
600003XXXXXXXXXXYYMMDD  
 EXP: YYYY-MM-DD LOT: XXXXXXXX

REF 600003  
  
600003XXXXXXXXXXYYMMDD  
 EXP: YYYY-MM-DD LOT: XXXXXXXX

**Delcath<sup>®</sup>**

Manufactured by:  
**Delcath Systems, Inc.**  
 Queensbury, NY 12804

40005.A

# Delcath<sup>®</sup>

## Hepatic Delivery System

For use with **HEPZATO<sup>™</sup>**  
(melphalan) for Injection

REF	600003	EXP: YYYY-MM-DD
		LOT: XXXXXXXX

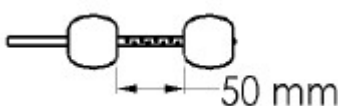

600003XXXXXXXXXXYYMMDD

# Delcath<sup>®</sup>

## Hepatic Delivery System

For use with **HEPZATO<sup>™</sup>**  
(melphalan) for Injection

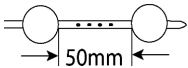

600003XXXXXXXXXXYYMMDD

**REF**

**600003**

**EXP:**

**YYYY-MM-DD**

**LOT:**

**XXXXXXXX**

40006.A

# Delcath<sup>®</sup>

## Hepatic Delivery System

For use with **HEPZATO<sup>™</sup>**  
(melphalan) for Injection

<b>REF</b> <b>600004</b>	<b>EXP: YYYY-MM-DD</b>
	<b>LOT: XXXXXXXX</b>

**Contents:**

- 1 - Double Balloon Catheter (62 mm Balloon Spacing)
- 1 - 5F Infusion Catheter - Cobra 2 (CB2) Tip
- 1 - Dual Hemofiltration Cartridge
- 1 - Hemofiltration Circuit
- 1 - CO<sub>2</sub> Connection Line
- 1 - 10F Introducer Set (Venous Return Sheath)
- 1 - 5F Introducer Set
- 1 - 9F and 13F Dilator Set
- 1 - 18F Introducer Set
- 1 - 18F Obturator

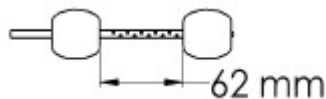

**Caution: This Double Balloon Catheter Contains Natural Rubber Latex Which May Cause Allergic Reactions.**

Consult the HEPZATO KIT<sup>™</sup> Instructions for Use prior to use.

**REF**      **600004**  
  
 600004XXXXXXXXXXYYYYMMDD  
 EXP: YYYY-MM-DD    LOT: XXXXXXXX

**REF**      **600004**  
  
 600004XXXXXXXXXXYYYYMMDD  
 EXP: YYYY-MM-DD    LOT: XXXXXXXX

**REF**      **600004**  
  
 600004XXXXXXXXXXYYYYMMDD  
 EXP: YYYY-MM-DD    LOT: XXXXXXXX

**Delcath<sup>®</sup>**

Manufactured by:  
**Delcath Systems, Inc.**  
 Queensbury, NY 12804

40007.A

# Delcath<sup>®</sup>

## Hepatic Delivery System

For use with **HEPZATO<sup>™</sup>**  
(melphalan) for Injection

<b>REF</b> <b>600004</b>	<b>EXP: YYYY-MM-DD</b>
	<b>LOT: XXXXXXXX</b>

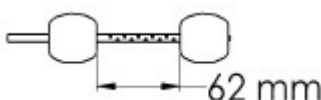

  
 600004XXXXXXXXXXYYYYMMDD

# Delcath<sup>®</sup>

## Hepatic Delivery System

For use with **HEPZATO<sup>™</sup>**  
(melphalan) for Injection

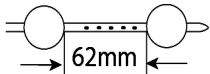

600004XXXXXXXXYYYYMMDD

**REF**

**600004**

**EXP:**

**YYYY-MM-DD**

**LOT:**

**XXXXXXXX**

40008.A



Ramesh  
Raghavachari

Digitally signed by Ramesh Raghavachari  
Date: 7/10/2024 11:52:36PM  
GUID: 502d0913000029f375128b0de8c50020