

HIGHLIGHTS OF PRESCRIBING INFORMATION

These highlights do not include all the information needed to use SKYLA safely and effectively. See full prescribing information for SKYLA.

SKYLA (levonorgestrel-releasing intrauterine system)

Initial U.S. Approval: 2000

INDICATIONS AND USAGE

Skyla is a progestin-containing intrauterine system (IUS) indicated for prevention of pregnancy for up to 3 years. (1)

DOSAGE AND ADMINISTRATION

- Release rate of levonorgestrel (LNG) is 14 mcg/day after 24 days and declines to 5 mcg/day after 3 years; Skyla must be removed or replaced after 3 years. (2)
- To be inserted by a trained healthcare provider using strict aseptic technique. Follow insertion instructions exactly as described. (2)
- Patient should be re-examined and evaluated 4 to 6 weeks after insertion; then, yearly or more often if indicated. (2.2)

DOSAGE FORMS AND STRENGTHS

- One sterile intrauterine system consisting of a T-shaped polyethylene frame with a steroid reservoir containing 13.5 mg levonorgestrel packaged within a sterile inserter (3)

CONTRAINDICATIONS

- Pregnancy or suspicion of pregnancy. Cannot be used for post-coital contraception (4)
- Congenital or acquired uterine anomaly if it distorts the uterine cavity (4)
- Acute pelvic inflammatory disease (PID) or a history of PID unless there has been a subsequent intrauterine pregnancy (4)
- Postpartum endometritis or infected abortion in the past 3 months (4)
- Known or suspected uterine or cervical neoplasia (4)
- Known or suspected breast cancer or other progestin-sensitive cancer (4)
- Uterine bleeding of unknown etiology (4)
- Untreated acute cervicitis or vaginitis or other lower genital tract infections (4)
- Acute liver disease or liver tumor (benign or malignant) (4)
- Increased susceptibility to pelvic infection (4)
- A previous intrauterine device (IUD) that has not been removed (4)

- Hypersensitivity to any component of Skyla (4)

WARNINGS AND PRECAUTIONS

- Remove Skyla if pregnancy occurs with Skyla in place. There is increased risk of ectopic pregnancy including loss of fertility, pregnancy loss, septic abortion (including septicemia, shock and death), and premature labor and delivery. (5.1, 5.2)
- Group A streptococcal infection has been reported; strict aseptic technique is essential during insertion. (5.3)
- Before using Skyla, consider the risks of PID. (5.4)
- Bleeding patterns become altered, may remain irregular and amenorrhea may ensue. (5.5)
- Perforation may occur and may reduce contraceptive effectiveness. Risk is increased if inserted in lactating women and may be increased if inserted in women with fixed retroverted uteri and postpartum. (5.6)
- Partial or complete expulsion may occur. (5.7)
- Evaluate persistent enlarged ovarian follicles. (5.8)
- Skyla can be safely scanned with MRI only under certain conditions (5.11)

ADVERSE REACTIONS

The most common adverse reactions reported (>10% users) are bleeding pattern alterations, vulvovaginitis, abdominal/pelvic pain, acne/seborrhea, ovarian cyst and headache. (6)

To report SUSPECTED ADVERSE REACTIONS, contact Bayer HealthCare Pharmaceuticals Inc. at 1-888-842-2937 or FDA at 1-800-FDA-1088 or www.fda.gov/medwatch

DRUG INTERACTIONS

- Drugs or herbal products that induce certain enzymes, such as CYP3A4, may decrease the serum concentration of progestins. (7)

USE IN SPECIFIC POPULATIONS

- Small amounts of progestins pass into breast milk resulting in detectable steroid levels in infant serum. (8.3)

See 17 for PATIENT COUNSELING INFORMATION and FDA-approved patient labeling

Revised: 04/2016

FULL PRESCRIBING INFORMATION: CONTENTS*

1 INDICATIONS AND USAGE

2 DOSAGE AND ADMINISTRATION

- 2.1 Insertion Instructions
- 2.2 Patient Follow-up
- 2.3 Removal of Skyla
- 2.4 Continuation of Contraception after Removal

3 DOSAGE FORMS AND STRENGTHS

4 CONTRAINDICATIONS

5 WARNINGS AND PRECAUTIONS

- 5.1 Ectopic Pregnancy
- 5.2 Intrauterine Pregnancy
- 5.3 Sepsis
- 5.4 Pelvic Infection
- 5.5 Bleeding Pattern Alterations
- 5.6 Perforation
- 5.7 Expulsion
- 5.8 Ovarian Cysts
- 5.9 Breast Cancer
- 5.10 Clinical Considerations for Use and Removal
- 5.11 Magnetic Resonance Imaging (MRI) Information

6 ADVERSE REACTIONS

- 6.1 Clinical Trials Experience
- 6.2 Postmarketing Experience

7 DRUG INTERACTIONS

8 USE IN SPECIFIC POPULATIONS

- 8.1 Pregnancy
- 8.3 Nursing Mothers
- 8.4 Pediatric Use
- 8.5 Geriatric Use
- 8.6 Hepatic Impairment
- 8.7 Renal Impairment

11 DESCRIPTION

- 11.1 Skyla
- 11.2 Inserter

12 CLINICAL PHARMACOLOGY

- 12.1 Mechanism of Action
- 12.2 Pharmacodynamics
- 12.3 Pharmacokinetics

13 NONCLINICAL TOXICOLOGY

- 13.1 Carcinogenesis, Mutagenesis, Impairment of Fertility

14 CLINICAL STUDIES

- 14.1 Clinical Trials on Contraception

15 REFERENCES

16 HOW SUPPLIED/STORAGE AND HANDLING

17 PATIENT COUNSELING INFORMATION

*Sections or subsections omitted from the full prescribing information are not listed.

FULL PRESCRIBING INFORMATION

1 INDICATIONS AND USAGE

Skyla[®] is indicated to prevent pregnancy for up to 3 years.

The system should be replaced after 3 years if continued use is desired.

2 DOSAGE AND ADMINISTRATION

Skyla contains 13.5 mg of levonorgestrel (LNG) released *in vivo* at a rate of approximately 14 mcg/day after 24 days. This rate decreases progressively to 5 mcg/day after 3 years. The average *in vivo* release rate of LNG is approximately 6 mcg/day over a period of 3 years.

Skyla must be removed by the end of the third year and can be replaced at the time of removal with a new Skyla if continued contraceptive protection is desired.

Skyla is supplied within an inserter in a sterile package (see Figure 1) that must not be opened until required for insertion [see Description (11)]. Do not use if the seal of the sterile package is broken or appears compromised. Use strict aseptic techniques throughout the insertion procedure [see Warnings and Precautions (5.3)].

Skyla and Inserter

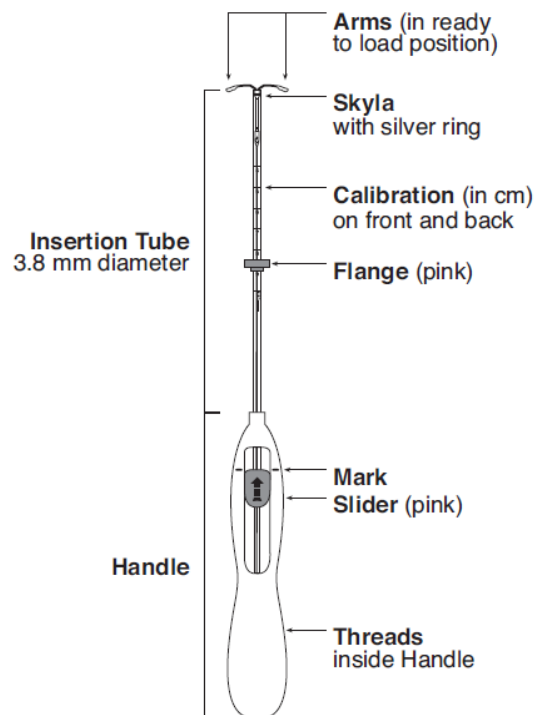

2.1. Insertion Instructions

- A complete medical and social history should be obtained to determine conditions that might influence the selection of a levonorgestrel-releasing intrauterine system (LNG IUS) for contraception. If indicated, perform a physical examination, and appropriate tests for any forms of genital or other sexually transmitted infections. [See Contraindications (4) and Warnings and Precautions (5.10).]

- Follow the insertion instructions exactly as described in order to ensure proper placement and avoid premature release of Skyla from the inserter. Once released, Skyla cannot be re-loaded.
- Skyla should be inserted by a trained healthcare provider. Healthcare providers should become thoroughly familiar with the insertion instructions before attempting insertion of Skyla.
- Insertion may be associated with some pain and/or bleeding or vasovagal reactions (for example, syncope, bradycardia) or seizure in an epileptic patient, especially in patients with a predisposition to these conditions. Consider administering analgesics prior to insertion.

Timing of Insertion

- Insert Skyla into the uterine cavity during the first seven days of the menstrual cycle or immediately after a first trimester abortion. Back up contraception is not needed when Skyla is inserted as directed.
- Postpone postpartum insertion and insertions following second trimester abortions a minimum of six weeks or until the uterus is fully involuted. If involution is delayed, wait until involution is complete before insertion [*see Warnings and Precautions (5.6, 5.7)*].

Tools for Insertion

Preparation

- Gloves
- Speculum
- Sterile uterine sound
- Sterile tenaculum
- Antiseptic solution, applicator

Procedure

- Sterile gloves
- Skyla with inserter in sealed package
- Instruments and anesthesia for paracervical block, if anticipated
- Consider having an unopened backup Skyla available
- Sterile, sharp curved scissors

Preparation for insertion

- Exclude pregnancy and confirm that there are no other contraindications to the use of Skyla.
- Ensure that the patient understands the contents of the Patient Information Booklet and obtain the signed patient informed consent located on the last page of the Patient Information Booklet.
- Check expiration date of Skyla prior to initiating insertion.
- With the patient comfortably in lithotomy position, do a bimanual exam to establish the size, shape and position of the uterus.
- Gently insert a speculum to visualize the cervix.
- Thoroughly cleanse the cervix and vagina with a suitable antiseptic solution.
- Prepare to sound the uterine cavity. Grasp the upper lip of the cervix with a tenaculum forceps and gently apply traction to stabilize and align the cervical canal with the uterine cavity. Perform a paracervical block if needed. If the uterus is retroverted, it may be more appropriate to grasp the lower lip of the cervix. The tenaculum should remain in position and gentle traction on the cervix should be maintained throughout the insertion procedure.
- Gently insert a uterine sound to check the patency of the cervix, measure the depth of the uterine cavity in centimeters, confirm cavity direction, and detect the presence of any uterine anomaly. If you encounter difficulty or cervical stenosis, use dilatation, and not force, to overcome resistance. If cervical dilatation is required, consider using a paracervical block.

Insertion Procedure

Proceed with insertion only after completing the above steps and ascertaining that the patient is appropriate for Skyla.
Ensure use of aseptic technique throughout the entire procedure.

Step 1–Opening of the package

- Open the package (Figure 1). The contents of the package are sterile.

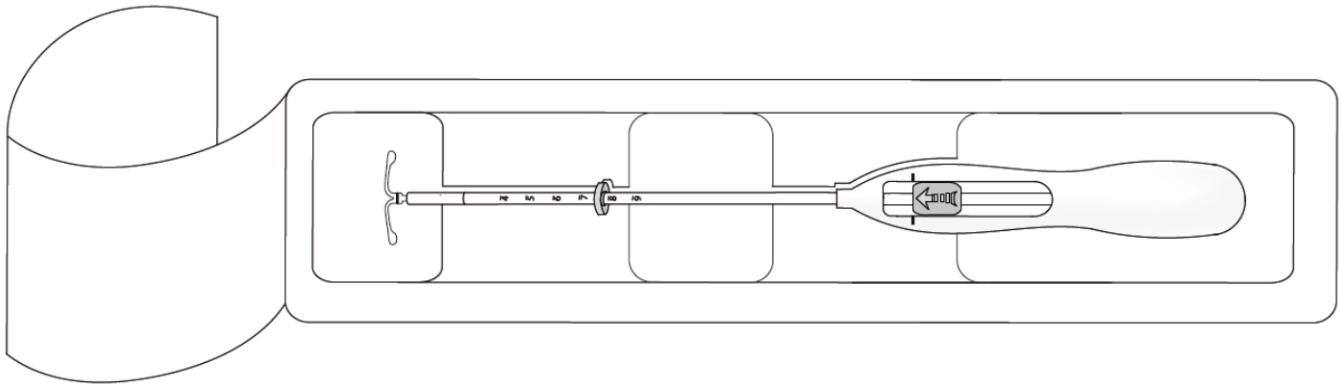

Figure 1. Opening the Skyla Package

- Using sterile gloves, lift the handle of the sterile inserter and remove from the sterile package.

Step 2–Load Skyla into the insertion tube

- Push the slider forward as far as possible in the direction of the arrow thereby moving the insertion tube over the Skyla T-body to load Skyla into the insertion tube (Figure 2). The tips of the arms will meet to form a rounded end that extends slightly beyond the insertion tube.

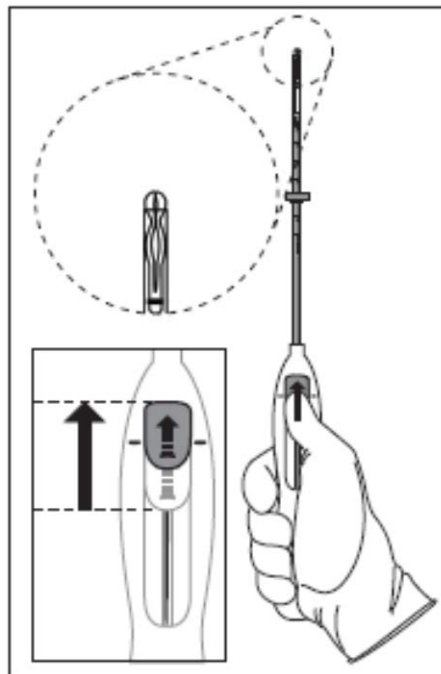

Figure 2. Move slider all the way to the forward position to load Skyla

- Maintain forward pressure with your thumb or forefinger on the slider. DO NOT move the slider downward at this time as this may prematurely release the threads of Skyla. Once the slider is moved below the mark, Skyla cannot be re-loaded.

NDA 203159 Skyla Bayer Response 6 April 2016

Step 3–Setting the Flange

- Holding the slider in this forward position, set the upper edge of the flange to correspond to the uterine depth (in centimeters) measured during sounding (Figure 3).

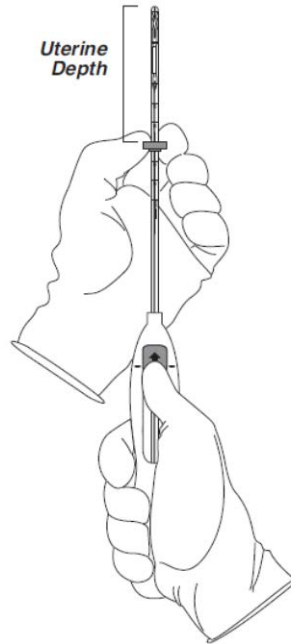

Figure 3. Setting the flange

Step 4–Skyla is now ready to be inserted

- Continue holding the slider in this forward position. Advance the inserter through the cervix until the flange is approximately 1.5–2 cm from the cervix and then pause (Figure 4).

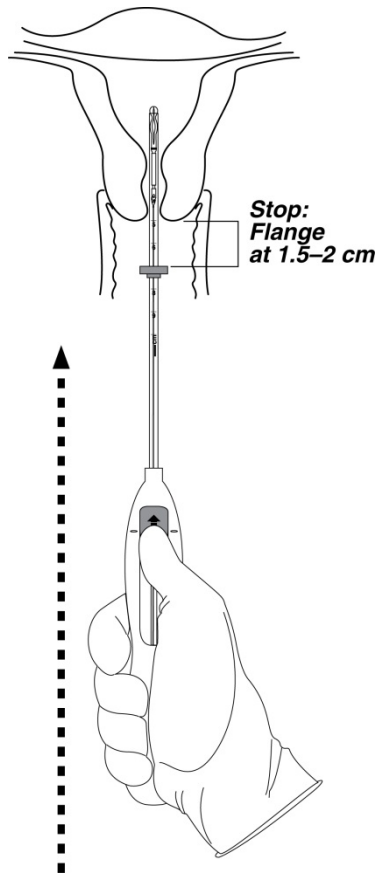

Figure 4. Advancing insertion tube until flange is 1.5 to 2 cm from the cervix

Do not force the inserter. If necessary, dilate the cervical canal.

Step 5–Open the arms

- While holding the inserter steady, move the slider down to the mark to release the arms of Skylar (Figure 5). Wait 10 seconds for the horizontal arms to open completely.

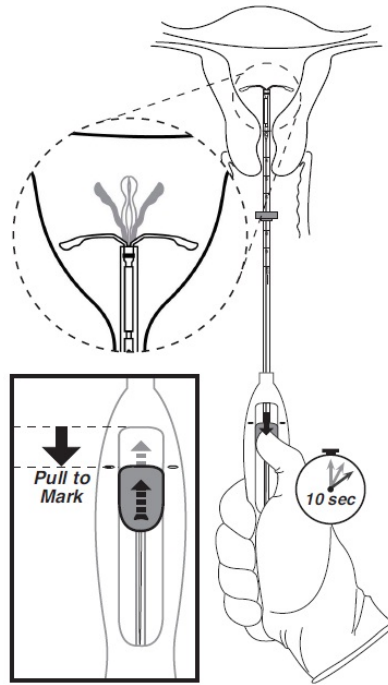

Figure 5. Move the slider back to the mark to release and open the arms

Step 6–Advance to fundal position

Advance the inserter gently towards the fundus of the uterus until the flange touches the cervix. If you encounter fundal resistance do not continue to advance. Skylar is now in the fundal position (Figure 6). Fundal positioning of Skylar is important to prevent expulsion.

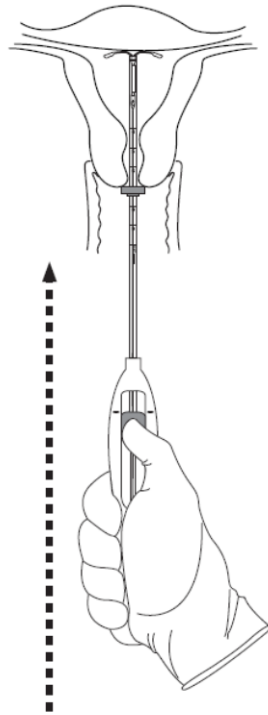

Figure 6. Move Skyla into the fundal position

Step 7—Release Skyla and withdraw the inserter

- Holding the entire inserter firmly in place, release Skyla by moving the slider all the way down (Figure 7).

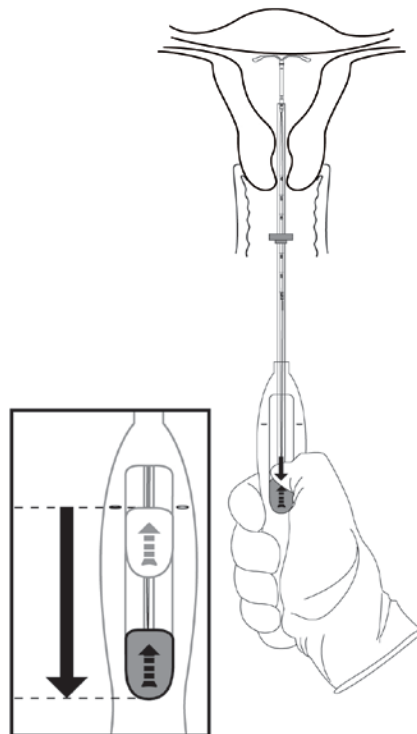

Figure 7. Move the slider all the way down to release Skyla from the insertion tube

- Continue to hold the slider all the way down while you slowly and gently withdraw the inserter from the uterus.
- Using a sharp, curved scissor, cut the threads perpendicular, leaving about 3 cm visible outside of the cervix [cutting threads at an angle may leave sharp ends (Figure 8)]. Do not apply tension or pull on the threads when cutting to prevent displacing Skyla.

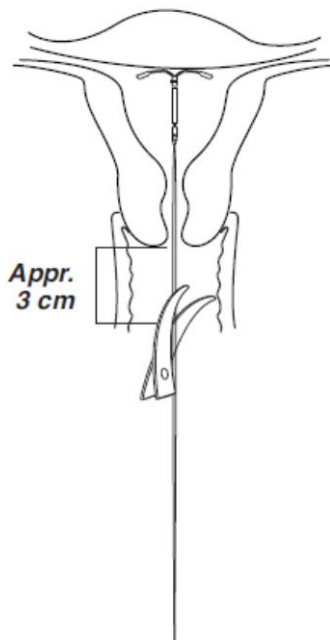

Figure 8. Cutting the threads

Skyla insertion is now complete. Prescribe analgesics, if indicated. Keep a copy of the Consent Form with lot number for your records.

Important information to consider during or after insertion

- If you suspect that Skyla is not in the correct position, check placement (for example, using transvaginal ultrasound). Remove Skyla if it is not positioned completely within the uterus. A removed Skyla must not be re-inserted.
- If there is clinical concern, exceptional pain or bleeding during or after insertion, appropriate steps should be taken immediately to exclude perforation, such as physical examination and ultrasound.

2.2 Patient Follow-up

- Patients should be reexamined and evaluated 4 to 6 weeks after insertion and once a year thereafter, or more frequently if clinically indicated.

2.3 Removal of Skyla

Timing of Removal

- Skyla should not remain in the uterus after 3 years.
- If pregnancy is not desired, the removal should be carried out during menstruation, provided the woman is still experiencing regular menses. If removal will occur at other times during the cycle, consider starting a new contraceptive method a week prior to removal. If removal occurs at other times during the cycle and the woman has had intercourse in the week prior to removal, she is at risk of pregnancy. [See *Dosage and Administration (2.4).*]

Tools for Removal

Preparation

- Gloves
- Speculum

Procedure

- Sterile forceps

Removal Procedure

- Remove Skyla by applying gentle traction on the threads with forceps (Figure 9).

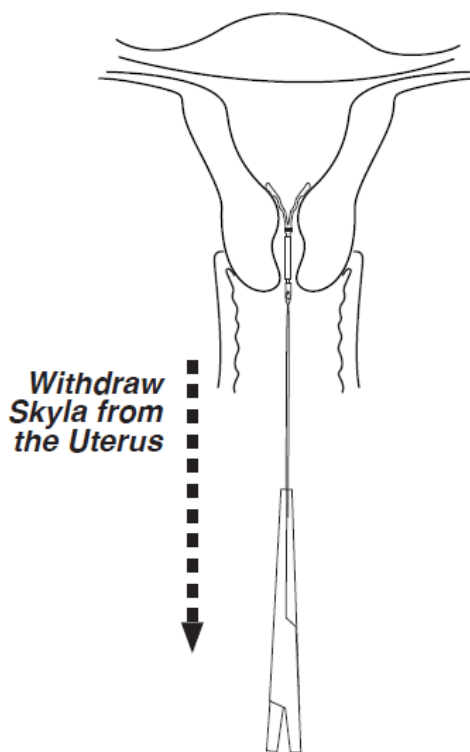

Figure 9. Removal of Skyla

- If the threads are not visible, determine location of Skyla by ultrasound [see *Warnings and Precautions (5.10)*].
- If Skyla is found to be in the uterine cavity on ultrasound exam, it may be removed using a narrow forceps, such as an alligator forceps. This may require dilation of the cervical canal. After removal of Skyla, the system should be examined to ensure that it is intact.
- Removal may be associated with some pain and/or bleeding or vasovagal reactions (for example, syncope, or a seizure in an epileptic patient).

2.4 Continuation of Contraception after Removal

- If pregnancy is not desired and if a woman wishes to continue using Skyla, a new system can be inserted immediately after removal any time during the cycle.
- If a patient with regular cycles wants to start a different birth control method, time removal and initiation of new method to ensure continuous contraception. Either remove Skyla during the first 7 days of the menstrual cycle and start the new method or start the new method at least 7 days prior to removing Skyla if removal is to occur at other times during the cycle.

- If a patient with irregular cycles or amenorrhea wants to start a different birth control method, start the new method at least 7 days before removal.

3 DOSAGE FORMS AND STRENGTHS

Skyla is a LNG-releasing IUS consisting of a T-shaped polyethylene frame with a steroid reservoir containing a total of 13.5 mg LNG.

4 CONTRAINDICATIONS

The use of Skyla is contraindicated when one or more of the following conditions exist:

- Pregnancy or suspicion of pregnancy; cannot be used for post-coital contraception
- Congenital or acquired uterine anomaly including fibroids if they distort the uterine cavity
- Acute pelvic inflammatory disease or a history of pelvic inflammatory disease unless there has been a subsequent intrauterine pregnancy
- Postpartum endometritis or infected abortion in the past 3 months
- Known or suspected uterine or cervical neoplasia
- Known or suspected breast cancer or other progestin-sensitive cancer, now or in the past
- Uterine bleeding of unknown etiology
- Untreated acute cervicitis or vaginitis, including bacterial vaginosis or other lower genital tract infections until infection is controlled
- Acute liver disease or liver tumor (benign or malignant)
- Conditions associated with increased susceptibility to pelvic infections
- A previously inserted IUD that has not been removed
- Hypersensitivity to any component of this product

5 WARNINGS AND PRECAUTIONS

5.1 Ectopic Pregnancy

Evaluate women for ectopic pregnancy if they become pregnant with Skyla in place because the likelihood of a pregnancy being ectopic is increased with Skyla. Approximately half of pregnancies that occur with Skyla in place are likely to be ectopic. Also consider the possibility of ectopic pregnancy in the case of lower abdominal pain, especially in association with missed periods or if an amenorrheic woman starts bleeding.

The incidence of ectopic pregnancy in clinical trials with Skyla, which excluded women with a history of ectopic pregnancy, was approximately 0.1% per year. The risk of ectopic pregnancy in women who have a history of ectopic pregnancy and use Skyla is unknown. Women with a previous history of ectopic pregnancy, tubal surgery or pelvic infection carry a higher risk of ectopic pregnancy. Ectopic pregnancy may result in loss of fertility.

5.2 Intrauterine Pregnancy

If pregnancy occurs while using Skyla, remove Skyla because leaving it in place may increase the risk of spontaneous abortion and preterm labor. Removal of Skyla or probing of the uterus may also result in spontaneous abortion. In the event of an intrauterine pregnancy with Skyla, consider the following:

Septic abortion

In patients becoming pregnant with an IUD in place, septic abortion—with septicemia, septic shock, and death—may occur.

NDA 203159 Skyla Bayer Response 6 April 2016

Continuation of pregnancy

If a woman becomes pregnant with Skyla in place and if Skyla cannot be removed or the woman chooses not to have it removed, warn her that failure to remove Skyla increases the risk of miscarriage, sepsis, premature labor and premature delivery. Follow her pregnancy closely and advise her to report immediately any symptom that suggests complications of the pregnancy.

Long-term effects and congenital anomalies

When pregnancy continues with Skyla in place, long-term effects on the offspring are unknown. With a LNG-releasing IUS, congenital anomalies in live births have occurred infrequently. No clear trend towards specific anomalies has been observed. Because of the local exposure of the fetus to LNG, the possibility of teratogenicity following exposure to Skyla cannot be completely excluded. Some observational data support a small increased risk of masculinization of the external genitalia of the female fetus following exposure to progestins at doses greater than those currently used for oral contraception. Whether these data apply to Skyla is unknown.

5.3 Sepsis

Severe infection or sepsis, including Group A streptococcal sepsis (GAS), have been reported following insertion of a LNG-releasing IUS. In some cases, severe pain occurred within hours of insertion followed by sepsis within days. Because death from GAS is more likely if treatment is delayed, it is important to be aware of these rare but serious infections. Aseptic technique during insertion of Skyla is essential in order to minimize serious infections such as GAS.

5.4 Pelvic Infection

Pelvic Inflammatory Disease (PID)

Skyla is contraindicated in the presence of known or suspected PID or in women with a history of PID unless there has been a subsequent intrauterine pregnancy [*see Contraindications (4)*]. IUDs have been associated with an increased risk of PID, most likely due to organisms being introduced into the uterus during insertion.¹ In clinical trials, PID was observed in 0.4% of women overall and occurred more frequently within the first year and most often within the first month after insertion of Skyla.

Promptly examine users with complaints of lower abdominal or pelvic pain, odorous discharge, unexplained bleeding, fever, genital lesions or sores. Remove Skyla in cases of recurrent endometritis or pelvic inflammatory disease, or if an acute pelvic infection is severe or does not respond to treatment.

Women at increased risk for PID

PID is often associated with a sexually transmitted infection, and Skyla does not protect against sexually transmitted infection. The risk of PID is greater for women who have multiple sexual partners, and also for women whose sexual partner(s) have multiple sexual partners. Women who have had PID are at increased risk for a recurrence or re-infection. In particular, ascertain whether the woman is at increased risk of infection (for example, leukemia, acquired immune deficiency syndrome [AIDS], IV drug abuse).

Asymptomatic PID

PID may be asymptomatic but still result in tubal damage and its sequelae.

Treatment of PID

Following a diagnosis of PID, or suspected PID, bacteriologic specimens should be obtained and antibiotic therapy should be initiated promptly. Removal of Skyla after initiation of antibiotic therapy is usually appropriate. Guidelines for PID treatment are available from the Centers for Disease Control (CDC), Atlanta, Georgia.

Actinomycosis

Actinomycosis has been associated with IUDs. Symptomatic women should have Skyla removed and should receive antibiotics. The significance of actinomyces-like organisms on Pap smear in an asymptomatic IUD user is unknown, and so this finding alone does not always require Skyla removal and treatment. When possible, confirm a Pap smear diagnosis with cultures.

5.5 Bleeding Pattern Alterations

Skyla can alter the bleeding pattern and result in spotting, irregular bleeding, heavy bleeding, oligomenorrhea and amenorrhea. During the first 3–6 months of Skyla use, the number of bleeding and spotting days may be higher and bleeding patterns may be irregular. Thereafter, the number of bleeding and spotting days usually decreases but bleeding may remain irregular. Amenorrhea develops by the end of the first year of use in approximately 6% of Skyla users. In Skyla clinical trials, a total of 77 subjects out of 1,672 (4.6%) discontinued due to uterine bleeding complaints. Table 1 shows the bleeding patterns as documented in the Skyla clinical trials based on 90-day reference periods. Table 2 shows the number of bleeding and spotting days based on 28-day cycle equivalents.

Table 1: Bleeding Patterns Reported with Skyla in Contraception Studies (by 90-day reference periods)

Skyla	First 90 days N=1,531	Second 90 days N=1,475	End of year 1 N=1,329	End of year 3 N=903
Amenorrhea ¹	<1%	3%	6%	12%
Infrequent bleeding ²	8%	19%	20%	22%
Frequent bleeding ³	31%	12%	8%	4%
Prolonged bleeding ⁴	59%	17%	9%	3%
Irregular bleeding ⁵	42%	28%	23%	– ⁶

¹Defined as subjects with no bleeding/spotting throughout the 90-day reference period

²Defined as subjects with 1 or 2 bleeding/spotting episodes in the 90-day reference period

³Defined as subjects with more than 5 bleeding/spotting episodes in the 90-day reference period

⁴Defined as subjects with bleeding/spotting episodes lasting more than 14 days in the 90-day reference period. Subjects with prolonged bleeding may also be included in one of the other categories (excluding amenorrhea)

⁵Defined as subjects with 3 to 5 bleeding/spotting episodes and less than 3 bleeding/spotting-free intervals of 14 or more days

⁶The End of year 3 result for irregular bleeding in particular is artificially inflated (46%) because removal was not timed to coincide with a complete 90-day reference period. The result from the preceding 90-day reference period (17%) provides a more relevant indication of the observed incidence near the end of the 3-year period.

Table 2: Mean number of Bleeding and Spotting Days per 28-day Cycle Equivalent

28-day Cycle Equivalent	Cycle 1 N=1,588		Cycle 4 N=1,535		Cycle 7 N=1,468		Cycle 13 N=1,345		Cycle 39 N=781	
Days on treatment	1–28		85–112		169–196		337–364		1065–1092	
	Mean	SD	Mean	SD	Mean	SD	Mean	SD	Mean	SD
Number of bleeding days	7.3	5.6	3.5	3.4	2.8	3.1	2.1	2.7	1.4	2.1
Number of spotting days	9.2	6.1	4.8	4.4	3.8	3.6	3.3	3.1	2.7	2.7

Because irregular bleeding/spotting is common during the first months of Skyla use, exclude endometrial pathology (polyps or cancer) prior to the insertion of Skyla in women with persistent or uncharacteristic bleeding. If a significant change in bleeding develops during prolonged use, take appropriate diagnostic measures to rule out endometrial pathology. The possibility of pregnancy should be considered if menstruation does not occur within six weeks of the onset

of a previous menstruation. Once pregnancy has been excluded, repeated pregnancy tests are generally not necessary in amenorrheic women unless indicated, for example, by other signs of pregnancy or by pelvic pain.

5.6 Perforation

Perforation (total or partial, including penetration/embedment of Skyla in the uterine wall or cervix) may occur most often during insertion, although the perforation may not be detected until sometime later. Perforation may reduce contraceptive efficacy and result in pregnancy. The incidence of perforation during clinical trials was < 0.1%.

If perforation occurs, locate and remove Skyla. Surgery may be required. Delayed detection or removal of Skyla in case of perforation may result in migration outside the uterine cavity, adhesions, peritonitis, intestinal perforations, intestinal obstruction, abscesses and erosion of adjacent viscera.

Clinical trials with Skyla excluded breast-feeding women. An interim analysis from a large postmarketing safety study with other IUDs shows an increased risk of perforation in lactating women. The risk of perforation may be increased if Skyla is inserted when the uterus is fixed retroverted or not completely involuted during the postpartum period. Delay Skyla insertion a minimum of six weeks or until involution is complete following a delivery or a second trimester abortion.

5.7 Expulsion

Partial or complete expulsion of Skyla may occur resulting in the loss of contraceptive protection. Expulsion may be associated with symptoms of bleeding or pain, or it may be asymptomatic and go unnoticed. Skyla typically decreases menstrual bleeding over time; therefore, an increase of menstrual bleeding may be indicative of an expulsion. The risk of expulsion may be increased when the uterus is not completely involuted. In clinical trials, a 3-year expulsion rate of 3.2% (54 out of 1665 subjects) was reported.

Delay Skyla insertion a minimum of six weeks or until uterine involution is complete following a delivery or a second trimester abortion. Remove a partially expelled Skyla. If expulsion has occurred, Skyla may be replaced within 7 days of a menstrual period after pregnancy has been ruled out.

5.8 Ovarian Cysts

Because the contraceptive effect of Skyla is mainly due to its local effects within the uterus, ovulatory cycles with follicular rupture usually occur in women of fertile age using Skyla. During clinical trials, ovarian cysts (reported as adverse reactions if they were abnormal, non-functional cysts and/or had a diameter >3 cm on ultrasound examination) were reported in 13.2% of women using Skyla. Most of these cysts are asymptomatic, although some may be accompanied by pelvic pain or dyspareunia. In most cases the ovarian cysts disappear spontaneously during two to three months observation. Persistent ovarian cysts should be evaluated. Surgical intervention is not usually required.

5.9 Breast Cancer

Women who currently have or have had breast cancer, or have a suspicion of breast cancer, should not use hormonal contraception because some breast cancers are hormone-sensitive [*see Contraindications (4)*].

Spontaneous reports of breast cancer have been received during postmarketing experience with a LNG-releasing IUS. Observational studies of the risk of breast cancer with use of a LNG-releasing IUS do not provide conclusive evidence of increased risk.

5.10 Clinical Considerations for Use and Removal

- Use Skyla with caution after careful assessment if any of the following conditions exist, and consider removal of the system if any of them arise during use:
 - Coagulopathy or use of anticoagulants

NDA 203159 Skyla Bayer Response 6 April 2016

- Migraine, focal migraine with asymmetrical visual loss or other symptoms indicating transient cerebral ischemia
- Exceptionally severe headache
- Marked increase of blood pressure
- Severe arterial disease such as stroke or myocardial infarction

In addition, consider removing Skyla if any of the following conditions arise during use [*see Contraindications (4)*]:

- Uterine or cervical malignancy
- Jaundice
- If the threads are not visible or are significantly shortened they may have broken or retracted into the cervical canal or uterus. Consider the possibility that the system may have been displaced, (for example, expelled or perforated the uterus) [*see Warnings and Precautions (5.6, 5.7)*]. Exclude pregnancy and verify the location of Skyla, for example, by sonography, X-ray, or by gentle exploration of the cervical canal with a suitable instrument. If Skyla is displaced, remove it. A new Skyla may be inserted at that time or during the next menses if it is certain that conception has not occurred. If Skyla is in place with no evidence of perforation, no intervention is indicated.

5.11 Magnetic Resonance Imaging (MRI) Information



Non-clinical testing has demonstrated that Skyla is MR Conditional. Skyla can be safely scanned only under specific conditions:

- Static magnetic field of 3 Tesla or less
- Spatial gradient field of 36,000 Gauss/cm (T/m) or less
- Maximum whole body averaged specific absorption rate (SAR) of 4W/kg in the First Level Controlled mode for 15 minutes of continuous scanning

In non-clinical testing, the Skyla produced a temperature rise of less than 1.8°C at a maximum whole body averaged specific absorption rate (SAR) of 2.9 W/kg, for 15 minutes of MR scanning at 3T using a transit/receive body coil.

MR Image quality may be compromised (that is, a small amount of artifact may occur) if the area of interest is in the exact same area or relatively close to the position of Skyla. Image artifact extended up to 5 mm from Skyla in a Gradient Echo pulse sequence.

6 ADVERSE REACTIONS

The following serious or otherwise important adverse reactions are discussed elsewhere in the labeling:

- Ectopic Pregnancy [*see Warnings and Precautions (5.1)*]
- Intrauterine Pregnancy [*see Warnings and Precautions (5.2)*]
- Group A Streptococcal Sepsis (GAS) [*see Warnings and Precautions (5.3)*]
- Pelvic Inflammatory Disease [*see Warnings and Precautions (5.4)*]
- Bleeding Pattern Alterations [*see Warnings and Precautions (5.5)*]
- Perforation [*see Warnings and Precautions (5.6)*]
- Expulsion [*see Warnings and Precautions (5.7)*]
- Ovarian Cysts [*see Warnings and Precautions (5.8)*]

6.1 Clinical Trials Experience

Because clinical trials are conducted under widely varying conditions, adverse reaction rates observed in the clinical trials of a drug cannot be directly compared to rates in the clinical trials of another drug and may not reflect the rates observed in clinical practice.

The data described below reflect exposure to Skyla in 1,672 patients in two contraception studies, including 1,383 exposed for one year and 993 who completed the three year studies. The population was generally healthy, 18 to 40-year old females requesting contraception and predominately Caucasian (82.6%). The data cover more than 40,000 cycles of exposure. The frequencies of reported adverse drug reactions represent crude incidences.

Most common adverse reactions (occurring in $\geq 5\%$ users) were increased bleeding (7.8%), vulvovaginitis (20.2%), abdominal/pelvic pain (18.9%), acne/seborrhea (15.0%), ovarian cyst (13.2%), headache (12.4%), dysmenorrhea (8.6%), breast pain/discomfort (8.6%) and nausea (5.5%).

In the contraception studies, 18% discontinued prematurely due to an adverse reaction. The most common adverse reactions leading to discontinuation (in $>1\%$ of users) were uterine bleeding complaints (4.6%), device expulsion (3.2%), acne/seborrhea (2.9%), abdominal pain (2.5%) dysmenorrhea/uterine spasms (2.0%) and pelvic pain (1.8%).

Other common adverse reactions (occurring in $\geq 1\%$ users) by System Organ Class (SOC): The frequencies of adverse reactions observed in clinical trials are summarized in Table 3 by SOC (presented as crude incidences).

Table 3: Adverse reactions that occurred in at least 1% of Skyla users in clinical trials by SOC

System Organ Class	Adverse Reaction	Incidence (%) (N=1,672)
Reproductive System and Breast Disorders	Vulvovaginitis	20.2
	Ovarian cyst ^a	13.2
	Dysmenorrhoea	8.6
	Increased bleeding ^b	7.8
	Breast pain/discomfort	5.3/3.3
	Genital discharge	4.2
	Device expulsion (complete and partial)	3.2
	Upper genital tract infection	1.4
Gastrointestinal Disorders	Abdominal pain/pelvic pain	12.7/6.2
	Nausea	5.5
Skin and Subcutaneous Tissue Disorders	Acne/Seborrhoea	13.6/1.4
	Alopecia	1.2
Nervous System Disorders	Headache	12.4
	Migraine	2.3
Psychiatric Disorders	Depression/ Depressed mood	3.8/0.5

^a Ovarian cysts were reported as AEs if they were abnormal, non-functional cysts and/or had a diameter >3 cm on ultrasound examination

^b Not all bleeding alterations were captured as adverse reactions [see *Warnings and Precautions (5.5)*].

6.2 Postmarketing Experience

The following adverse reactions have been identified during post approval use of a LNG-releasing IUS. Because these reactions are reported voluntarily from a population of uncertain size, it is not always possible to reliably estimate their frequency or establish a causal relationship to drug exposure.

- Arterial thrombotic and venous thromboembolic events, including cases of pulmonary emboli, deep vein thrombosis and stroke
- Hypersensitivity including rash, urticaria, and angioedema
- Device breakage

7 DRUG INTERACTIONS

No drug-drug interaction studies have been conducted with Skyla.

Drugs or herbal products that induce enzymes, including CYP3A4, that metabolize progestins may decrease the serum concentrations of progestins.

Some drugs or herbal products that may decrease the serum concentration of LNG include:

NDA 203159 Skyla Bayer Response 6 April 2016

- Barbiturates
- Bosentan
- Carbamazepine
- Efavirenz
- Felbamate
- Griseofulvin
- Nevirapine
- Oxcarbazepine
- Phenytoin
- Rifabutin
- Rifampin
- St. John's wort
- Topiramate

Significant changes (increase or decrease) in the serum concentrations of the progestin have been noted in some cases of co-administration with HIV protease inhibitors or with non-nucleoside reverse transcriptase inhibitors. CYP3A4 inhibitors such as itraconazole or ketoconazole may increase plasma hormone levels.

Consult the labeling of all concurrently used drugs to obtain further information about interactions with Skyla or the potential for enzyme alterations.

8 USE IN SPECIFIC POPULATIONS

8.1 Pregnancy

The use of Skyla during an existing or suspected pregnancy is contraindicated. Many studies have found no harmful effects on fetal development associated with long-term use of contraceptive doses of oral progestins. The few studies of infant growth and development that have been conducted with progestin-only pills have not demonstrated significant adverse effects. *[See Contraindications (4) and Warnings and Precautions (5.1, 5.2).]*

8.3 Nursing Mothers

In general, no adverse effects of progestin-only contraceptives have been found on breastfeeding performance or on the health, growth, or development of the infant. Isolated postmarketing cases of decreased milk production have been reported. Small amounts of progestins were observed to pass into the breast milk of nursing mothers who used a LNG-releasing IUS, resulting in detectable steroid levels in infant serum. *[See Warnings and Precautions (5.6).]*

8.4 Pediatric Use

Safety and efficacy of Skyla have been established in women of reproductive age. Efficacy is expected to be the same for postpubertal females under the age of 18 as for users 18 years and older. Use of this product before menarche is not indicated.

8.5 Geriatric Use

Skyla has not been studied in women over age 65 and is not approved for use in this population.

8.6 Hepatic Impairment

No studies were conducted to evaluate the effect of hepatic disease on the disposition of LNG released from Skyla [see *Contraindications (4)*].

8.7 Renal Impairment

No studies were conducted to evaluate the effect of renal disease on the disposition of LNG released from Skyla.

11 DESCRIPTION

Skyla (LNG-releasing intrauterine system) contains 13.5 mg of LNG, a progestin, and is intended to provide an initial release rate of approximately 14 mcg/day of LNG after 24 days.

Levonorgestrel USP, (-)-13-Ethyl-17-hydroxy-18,19-dinor-17 α -pregn-4-en-20-yn-3-one, the active ingredient in Skyla, has a molecular weight of 312.4, a molecular formula of C₂₁H₂₈O₂, and the following structural formula:

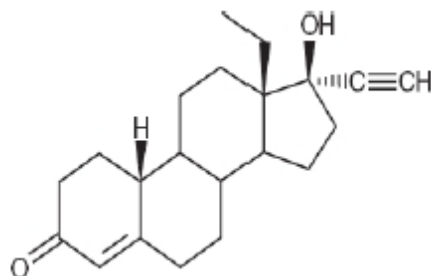

11.1 Skyla

Skyla consists of a T-shaped polyethylene frame (T-body) with a steroid reservoir (hormone elastomer core) around the vertical stem. The T-body has a loop at one end of the vertical stem and two horizontal arms at the other end. The reservoir consists of a whitish or pale yellow cylinder, made of a mixture of LNG and silicone (polydimethylsiloxane), containing a total of 13.5 mg LNG. The reservoir is covered by a semi-opaque silicone membrane, composed of polydimethylsiloxane and colloidal silica. A ring composed of 99.95% pure silver is located at the top of the vertical stem close to the horizontal arms and is visible by ultrasound. The polyethylene of the T-body is compounded with barium sulfate, which makes it radiopaque. A monofilament brown polyethylene removal thread is attached to a loop at the end of the vertical stem of the T-body. The polyethylene of the removal thread contains iron oxide as a colorant (see Figure 10).

The components of Skyla, including its packaging, are not manufactured using natural rubber latex.

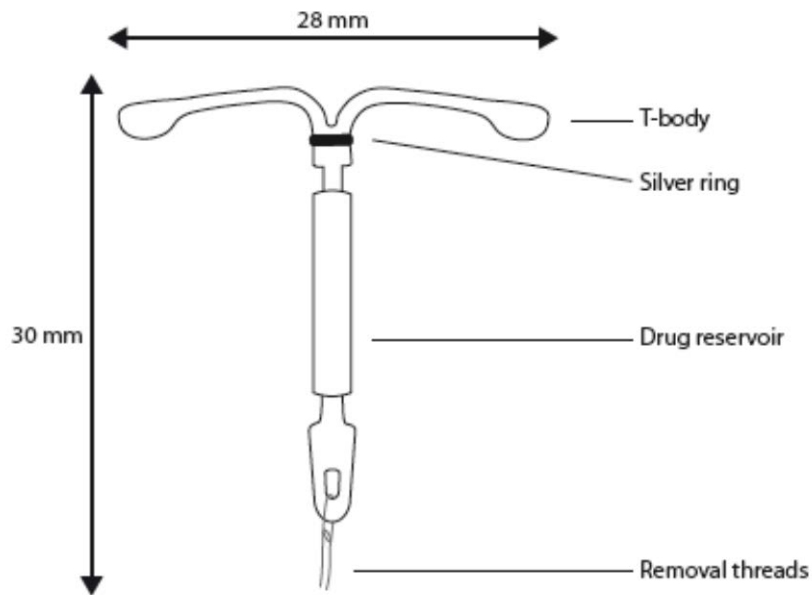

Figure 10. Skylia

11.2 Inserter

Skylia is packaged sterile within an inserter. The inserter (Figure 11), which is used for insertion of Skylia into the uterine cavity, consists of a symmetric two-sided body and slider that are integrated with flange, lock, pre-bent insertion tube and plunger. The outer diameter of the insertion tube is 3.8 mm. The vertical stem of Skylia is loaded in the insertion tube at the tip of the inserter. The arms are pre-aligned in the horizontal position. The removal threads are contained within the insertion tube and handle. Once Skylia has been placed, the inserter is discarded.

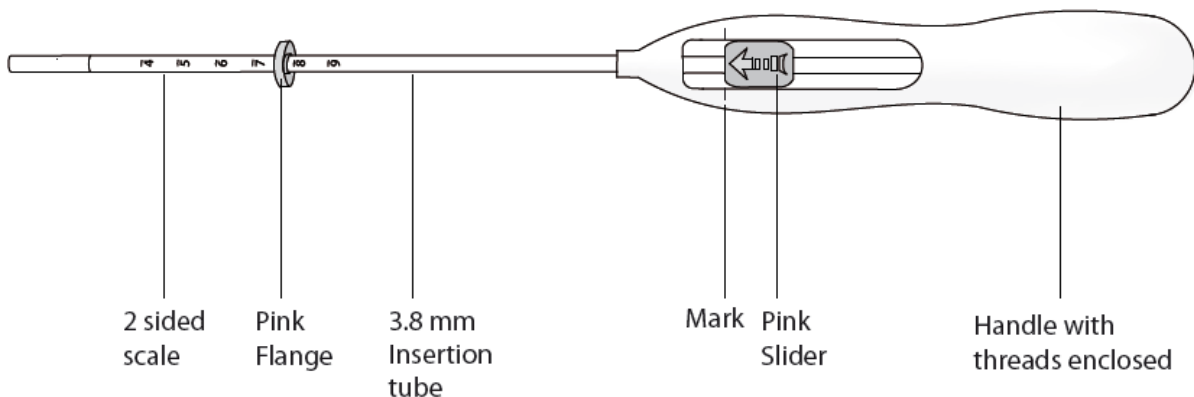

Figure 11. Diagram of Inserter

12 CLINICAL PHARMACOLOGY

12.1 Mechanism of Action

The local mechanism by which continuously released LNG enhances contraceptive effectiveness of Skyla has not been conclusively demonstrated. Studies of Skyla and similar LNG IUS prototypes have suggested several mechanisms that prevent pregnancy: thickening of cervical mucus preventing passage of sperm into the uterus, inhibition of sperm capacitation or survival, and alteration of the endometrium.

12.2 Pharmacodynamics

Skyla has mainly local progestogenic effects in the uterine cavity. The high local levels of LNG² lead to morphological changes including stromal pseudodecidualization, glandular atrophy, a leukocytic infiltration and a decrease in glandular and stromal mitoses.

In clinical trials with Skyla, ovulation was observed in the majority of a subset of subjects studied. Evidence of ovulation was seen in 34 out of 35 women in the first year, in 26 out of 27 women in the second year, and in all 27 women in the third year.

12.3 Pharmacokinetics

Absorption

Low doses of LNG are administered into the uterine cavity with the Skyla intrauterine delivery system. The *in vivo* release rate is approximately 14 mcg/day after 24 days and is reduced to approximately 10 mcg/day after 60 days and then decreases progressively to approximately 5 mcg/day after three years. The average LNG *in vivo* release rate is approximately 6 mcg/day over the period of three years.

In a subset of 7 subjects, maximum observed serum LNG concentration was 192 ± 105 pg/mL, reached after 2 days (median) of Skyla insertion. Thereafter, LNG serum concentration decreased after long-term use of 12, 24, and 36 months to concentrations of 77 ± 21 pg/mL, 62 ± 38 pg/mL, and 72 ± 29 pg/mL, respectively. A population pharmacokinetic evaluation based on a broader data base (>1000 patients) showed similar concentration data of 168 ± 46 pg/mL at 7 days after placement. Thereafter, LNG serum concentrations decline slowly to a value 61 ± 19 pg/mL after 3 years.

Distribution

The apparent volume of distribution of LNG is reported to be approximately 1.8 L/kg. Levonorgestrel is bound non-specifically to serum albumin and specifically to sex hormone binding globulin (SHBG). Accordingly, changes in the concentration of SHBG in serum result in an increase (at higher SHBG concentration) or a decrease (at lower SHBG concentration) of the total LNG concentration in serum. In a subset of 7 subjects, the concentration of SHBG declined by a mean value of 18% within 2 weeks after insertion of Skyla and remains relatively stable over the 3 year period of use. Thereafter, plateau-like SHBG concentrations were observed. Less than 2 % of the circulating LNG is present as free steroid.

Metabolism

Following absorption, LNG is conjugated at the 17 β -OH position to form sulfate conjugates and, to a lesser extent, glucuronide conjugates in serum. Significant amounts of conjugated and unconjugated 3 α , 5 β -tetrahydroLNG are also present in serum, along with much smaller amounts of 3 α , 5 α -tetrahydrolevonorgestrel and 16 β -hydroxylevonorgestrel. LNG and its phase I metabolites are excreted primarily as glucuronide conjugates. Metabolic clearance rates may differ among individuals by several-fold, and this may account in part for wide individual variations in LNG concentrations seen in individuals using LNG-containing contraceptive products. *In vitro* studies have demonstrated that oxidative metabolism of LNG is catalyzed by CYP enzymes, especially CYP3A4.

Excretion

About 45% of LNG and its metabolites are excreted in the urine and about 32% are excreted in feces, mostly as glucuronide conjugates. The elimination half-life of LNG after parenteral administration is approximately 20 hours.

Specific Populations

Pediatric: Safety and efficacy of Skyla have been established in women of reproductive age. Use of this product before menarche is not indicated.

Geriatric: Skyla has not been studied in women over age 65 and is not currently approved for use in this population.

Race: No studies have evaluated the effect of race on pharmacokinetics of Skyla.

Hepatic Impairment: No studies were conducted to evaluate the effect of hepatic disease on the disposition of Skyla.

Renal Impairment: No formal studies were conducted to evaluate the effect of renal disease on the disposition of Skyla.

Drug-Drug Interactions

No drug-drug interaction studies were conducted with Skyla [see *Drug Interactions (7)*].

13 NONCLINICAL TOXICOLOGY

13.1 Carcinogenesis, Mutagenesis, Impairment of Fertility

[See *Warnings and Precautions (5.9)*.]

14 CLINICAL STUDIES

14.1 Clinical Trials on Contraception

The contraceptive efficacy of Skyla was demonstrated in a clinical trial that enrolled generally healthy women aged 18–35, 1,432 of whom received Skyla. The Skyla arm included 38.8 % (556) nulliparous women. The trial was a multicenter, multi-national, randomized open label study conducted in 11 countries in Europe, Latin America, the US and Canada. Women less than six weeks postpartum, with a history of ectopic pregnancy, with clinically significant ovarian cysts or with HIV or otherwise at high risk for sexually transmitted infections were excluded. For Skyla-treated women, 540 (37.7%) were treated at US sites and 892 (62.3%) were at non-US sites. The racial demographic of enrolled women who received Skyla was: Caucasian (79.7%), Hispanic (11.5%), Black (5.2%), Asian (0.8%), and Other (2.7%). The weight range for treated women was 38 to 155 kg (mean weight: 68.7 kg) and mean BMI was 25.3 kg/m² (range 16–55 kg/m²). Of Skyla-treated women, 21.9% discontinued the study treatment due to an adverse event, 4.4% were lost to follow up, 1.8% withdrew their consent, 13.0% discontinued due to other reason, 1.1% discontinued due to protocol deviation, and 0.6% discontinued due to pregnancy.

The pregnancy rate calculated as the Pearl Index (PI) in women aged 18–35 years was the primary efficacy endpoint used to assess contraceptive reliability. The PI was calculated based on 28-day equivalent exposure cycles; evaluable cycles excluded those in which back-up contraception was used unless a pregnancy occurred in that cycle. Skyla-treated women provided 15,763 evaluable 28-day cycle equivalents in the first year and 39,368 evaluable cycles over the three year treatment period. The PI estimate for the first year of use based on the 5 pregnancies that occurred after the onset of treatment and within 7 days after Skyla removal or expulsion was 0.41 with a 95% upper confidence limit of 0.96. The cumulative 3-year pregnancy rate, based on 10 pregnancies, estimated by the Kaplan-Meier method was 0.9 per 100 women or 0.9%, with a 95% upper confidence limit of 1.7%.

About 77% of women wishing to become pregnant conceived within 12 months after removal of Skyla.

15 REFERENCES

¹Farley T M M, Rosenberg M J, Rowe P J, Chen J, Meirik O. Intrauterine devices and pelvic inflammatory disease: an international perspective. *Lancet* 1992; 339:785-788.

²Nilsson CG, Haukkamaa M, Vierola H, Luukkainen T. Tissue concentrations of LNG in women using a LNG-releasing IUD. *Clinical Endocrinol* 1982; 17:529-536.

16 HOW SUPPLIED/STORAGE AND HANDLING

Skyla (levonorgestrel-releasing intrauterine system), containing a total of 13.5 mg LNG, is available in a carton of one sterile unit. NDC# 50419-422-01

Skyla is supplied sterile. Skyla is sterilized with ethylene oxide. Do not resterilize. For single use only. Do not use if the inner package is damaged or open. Insert before the end of the month shown on the label.

Store at 25°C (77°F); with excursions permitted between 15–30°C (59–86°F) [see USP Controlled Room Temperature].

17 PATIENT COUNSELING INFORMATION

See FDA-approved patient labeling (Patient Information)

- Counsel the patient that this product does not protect against HIV infection (AIDS) and other sexually transmitted diseases (STDs).
- Counsel the patient on the benefits, risks, and side effects of Skyla prior to insertion. Provide the Patient Information Booklet and give her the opportunity to read the information and discuss fully any questions she may have concerning Skyla as well as other methods of contraception. Advise the patient that the Full Prescribing Information is available to her upon request.
- Inform the patient about the risks of ectopic pregnancy, including the loss of fertility. Teach her to recognize and report to her healthcare provider promptly any symptoms of ectopic pregnancy.
- Inform the patient about the possibility of PID and that PID can cause tubal damage leading to ectopic pregnancy or infertility, or infrequently can necessitate hysterectomy, or cause death. Teach patients to recognize and report to their physician promptly any symptoms of pelvic inflammatory disease. These symptoms include development of menstrual disorders (prolonged or heavy bleeding), unusual vaginal discharge, abdominal or pelvic pain or tenderness, dyspareunia, chills, and fever.
- Counsel the patient that irregular or prolonged bleeding and spotting, and/or cramps may occur during the first few weeks after insertion. If her symptoms continue or are severe she should report them to her healthcare provider.
- Counsel the patient on how she can check that the threads still protrude from the cervix and caution her not to pull on the threads and displace Skyla. Inform her that there is no contraceptive protection if Skyla is displaced or expelled. [See *Warnings and Precautions* (5.6, 5.7).]
- Instruct the patient to contact her healthcare provider if she experiences any of the following:
 - A stroke or heart attack
 - Very severe or migraine headaches
 - Unexplained fever
 - Yellowing of the skin or whites of the eyes, as these may be signs of serious liver problems
 - Pregnancy or suspected pregnancy
 - Pelvic pain or pain during sex
 - HIV positive seroconversion in herself or her partner

NDA 203159 Skyla Bayer Response 6 April 2016

- Possible exposure to sexually transmitted infections (STIs)
- Unusual vaginal discharge or genital sores
- Severe vaginal bleeding or bleeding that lasts a long time, or if she misses a menstrual period
- Inability to feel Skyla's threads
- Inform the patient that Skyla can be safely scanned with MRI only under specific conditions [*see Warnings and Precautions (5.11)*]. Instruct patients who will have an MRI to tell their doctor that they have Skyla. This information is included on the Follow-Up Reminder Card.
- Complete the Follow-up Reminder Card and give to the patient.

FDA-Approved Patient Labeling

Patient Information

Skyla (sky-lah)

(levonorgestrel-releasing intrauterine system)

Skyla does not protect against HIV infection (AIDS) and other sexually transmitted infections (STIs).

Read this Patient Information carefully before you decide if Skyla is right for you. This information does not take the place of talking with your gynecologist or other healthcare provider who specializes in women's health. If you have any questions about Skyla, ask your healthcare provider. You should also learn about other birth control methods to choose the one that is best for you.

What is Skyla?

- Skyla is a hormone-releasing system placed in your uterus by your healthcare provider to prevent pregnancy for up to 3 years.
- Skyla can be removed by your healthcare provider at any time.
- Skyla can be used whether or not you have had a child.

Skyla is a small, flexible plastic T-shaped system that slowly releases a progestin hormone called levonorgestrel that is often used in birth control pills. Because Skyla releases levonorgestrel into your uterus, only small amounts of the hormone enter your blood. Skyla does not contain estrogen.

Two thin threads are attached to the stem of Skyla. The threads are the only part of Skyla you can feel when Skyla is in your uterus; however, unlike a tampon string, the threads do not extend outside your body.

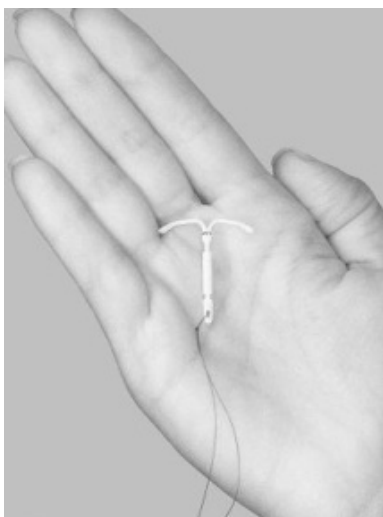

Skyla is small

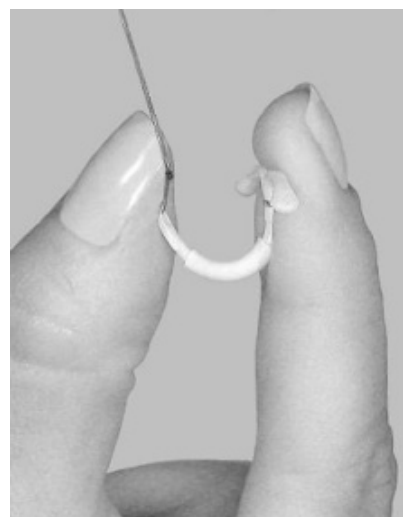

and flexible

What if I need birth control for more than 3 years?

Skyla must be removed after 3 years. Your healthcare provider can place a new Skyla during the same office visit if you choose to continue using Skyla.

What if I want to stop using Skyla?

Skyla is intended for long-term use but you can stop using Skyla at any time by asking your healthcare provider to remove it. You could become pregnant as soon as Skyla is removed, so you should use another method of birth control if you do not want to become pregnant.

What if I change my mind about birth control and want to become pregnant in less than 3 years?

Your healthcare provider can remove Skyla at any time. You may become pregnant as soon as Skyla is removed. About 3 out of 4 women who want to become pregnant will become pregnant sometime in the first year after Skyla is removed.

How does Skyla work?

Skyla may work in several ways including thickening cervical mucus, inhibiting sperm movement, reducing sperm survival, and thinning the lining of your uterus. It is not known exactly how these actions work together to prevent pregnancy.

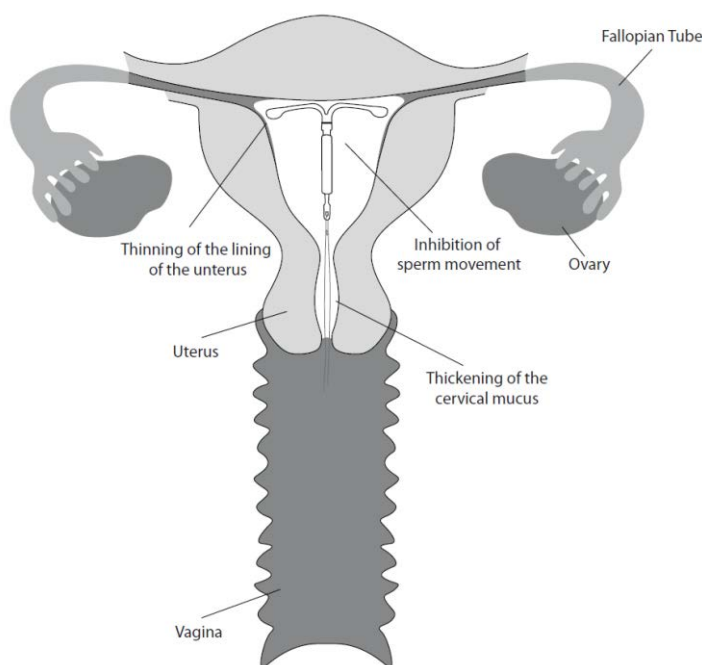

How well does Skyla work for contraception?

The following chart shows the chance of getting pregnant for women who use different methods of birth control. Each box on the chart contains a list of birth control methods that are similar in effectiveness. The most effective methods are at the top of the chart. The box on the bottom of the chart shows the chance of getting pregnant for women who do not use birth control and are trying to get pregnant.

Skyla, an intrauterine device (IUD), is in the box at the top of the chart.

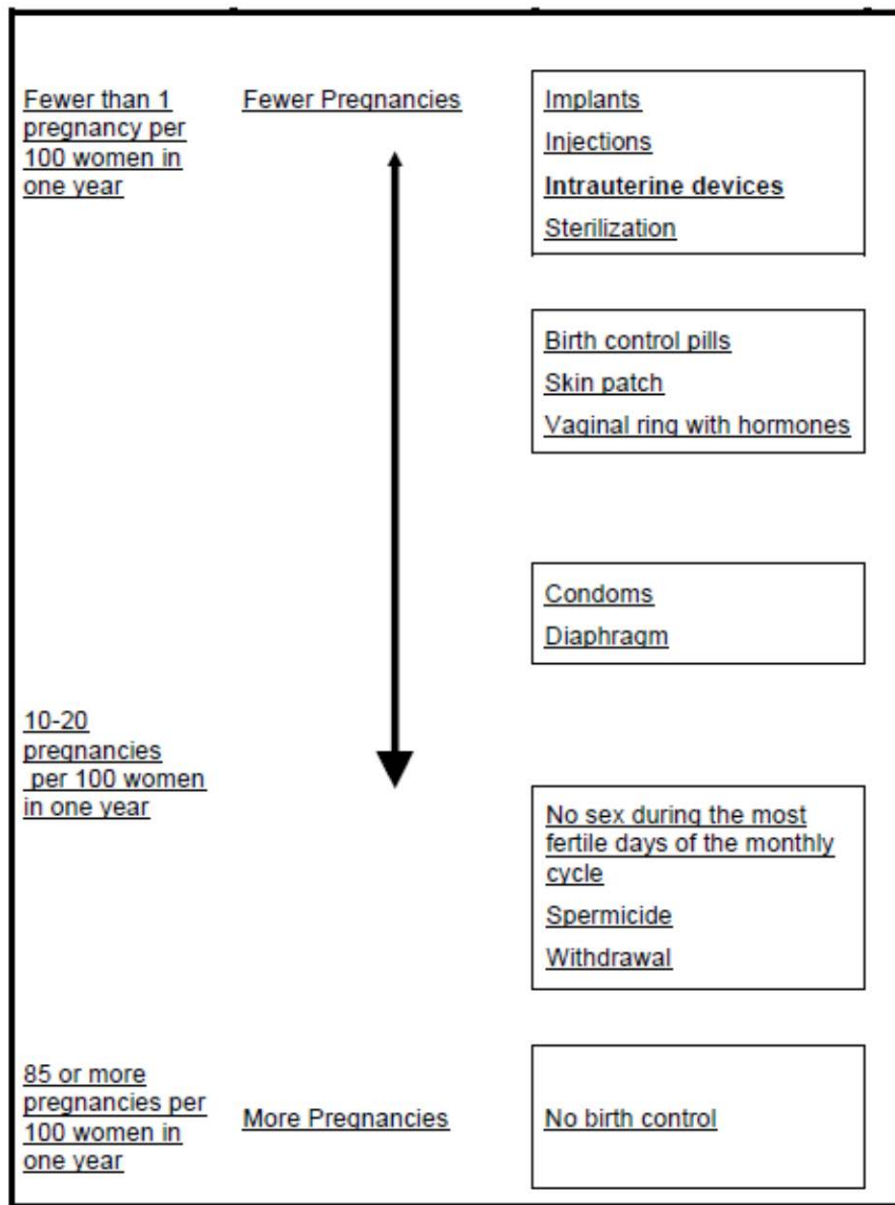

Who might use Skyla?

You might choose Skyla if you:

- Want long-term birth control that provides a low chance of getting pregnant (less than 1 in 100)
- Want birth control that works continuously for up to 3 years
- Want birth control that is reversible
- Want a birth control method that you do not need to take daily
- Are willing to use a birth control method that is placed in the uterus
- Want birth control that does not contain estrogen

Who should not use Skyla?

Do not use Skyla if you:

- Are or might be pregnant; Skyla cannot be used as an emergency contraceptive

NDA 203159 Skyla Bayer Response 6 April 2016

- Have had a serious pelvic infection called pelvic inflammatory disease (PID) unless you have had a normal pregnancy after the infection went away
- Have an untreated pelvic infection now
- Have had a serious pelvic infection in the past 3 months after a pregnancy
- Can get infections easily. For example, if you have:
 - Multiple sexual partners or your partner has multiple sexual partners
 - Problems with your immune system
 - Intravenous drug abuse
- Have or suspect you might have cancer of the uterus or cervix
- Have bleeding from the vagina that has not been explained
- Have liver disease or liver tumor
- Have breast cancer or any other cancer that is sensitive to progestin (a female hormone), now or in the past
- Have an intrauterine device in your uterus already
- Have a condition of the uterus that changes the shape of the uterine cavity, such as large fibroid tumors
- Are allergic to levonorgestrel, silicone, polyethylene, silver, silica, barium sulfate or iron oxide

Before having Skyla placed, tell your healthcare provider if you:

- Have had a heart attack
- Have had a stroke
- Were born with heart disease or have problems with your heart valves
- Have problems with blood clotting or take medicine to reduce clotting
- Have high blood pressure
- Recently had a baby or if you are breastfeeding
- Have severe migraine headaches

How is Skyla placed?

Skyla is placed by your healthcare provider during an in-office visit.

First, your healthcare provider will examine your pelvis to find the exact position of your uterus. Your healthcare provider will then clean your vagina and cervix with an antiseptic solution and slide a slim plastic tube containing Skyla into your uterus. Your healthcare provider will then remove the plastic tube, and leave Skyla in your uterus. Your healthcare provider will cut the threads to the right length. Placement takes only a few minutes.

You may experience pain, bleeding or dizziness during and after placement. If your symptoms do not pass within 30 minutes after placement, Skyla may not have been placed correctly. Your healthcare provider will examine you to see if Skyla needs to be removed or replaced.

Should I check that Skyla is in place?

Yes, you should check that Skyla is in proper position by feeling the removal threads. It is a good habit to do this once a month. Your healthcare provider should tell you how to check that Skyla is in place. First, wash your hands with soap and water. You can check by reaching up to

the top of your vagina with clean fingers to feel the removal threads. Do not pull on the threads. If you feel more than just the threads or if you cannot feel the threads, Skyla may not be in the right position and may not prevent pregnancy. Use non-hormonal back-up birth control (such as condoms and spermicide) and ask your healthcare provider to check that Skyla is still in the right place.

How soon after placement of Skyla should I return to my healthcare provider?

Call your healthcare provider if you have any questions or concerns (see “When should I call my healthcare provider”). Otherwise, you should return to your healthcare provider for a follow-up visit 4 to 6 weeks after Skyla is placed to make sure that Skyla is in the right position.

Can I use tampons with Skyla?

Tampons may be used with Skyla.

What if I become pregnant while using Skyla?

Call your healthcare provider right away if you think you are pregnant. If you get pregnant while using Skyla, you may have an ectopic pregnancy. This means that the pregnancy is not in the uterus. Unusual vaginal bleeding or abdominal pain may be a sign of ectopic pregnancy.

Ectopic pregnancy is a medical emergency that often requires surgery. Ectopic pregnancy can cause internal bleeding, infertility, and even death.

There are also risks if you get pregnant while using Skyla and the pregnancy is in the uterus. Severe infection, miscarriage, premature delivery, and even death can occur with pregnancies that continue with an intrauterine device (IUD). Because of this, your healthcare provider may try to remove Skyla, even though removing it may cause a miscarriage. If Skyla cannot be removed, talk with your healthcare provider about the benefits and risks of continuing the pregnancy.

If you continue your pregnancy, see your healthcare provider regularly. Call your healthcare provider right away if you get flu-like symptoms, fever, chills, cramping, pain, bleeding, vaginal discharge, or fluid leaking from your vagina. These may be signs of infection.

It is not known if Skyla can cause long-term effects on the fetus if it stays in place during a pregnancy.

How will Skyla change my periods?

For the first 3 to 6 months, your period may become irregular and the number of bleeding days may increase. You may also have frequent spotting or light bleeding. Some women have heavy bleeding during this time. After you have used Skyla for a while, the number of bleeding and spotting days is likely to lessen. There is a small chance that your periods will stop altogether.

Is it safe to breastfeed while using Skyla?

You may use Skyla when you are breastfeeding if more than six weeks have passed since you had your baby. If you are breastfeeding, Skyla is not likely to affect the quality or amount of your breast milk or the health of your nursing baby. However, isolated cases of decreased milk production have been reported among women using progestin-only birth control pills.

Will Skyla interfere with sexual intercourse?

You and your partner should not feel Skyla during intercourse. Skyla is placed in the uterus, not in the vagina. Sometimes your partner feels the threads. If this occurs, talk with your healthcare provider.

NDA 203159 Skyla Bayer Response 6 April 2016

Can I have an MRI with Skyla in place?

Skyla can be safely scanned with MRI only under specific conditions. Before you have an MRI, tell your healthcare provider that you have Skyla.

What are the possible side effects of Skyla?

Skyla can cause serious side effects, including:

- **Pelvic inflammatory disease (PID).** Some IUD users get a serious pelvic infection called pelvic inflammatory disease. PID is usually sexually transmitted. You have a higher chance of getting PID if you or your partner have sex with other partners. PID can cause serious problems such as infertility, ectopic pregnancy or pelvic pain that does not go away. PID is usually treated with antibiotics. More serious cases of PID may require surgery. A hysterectomy (removal of the uterus) is sometimes needed. In rare cases, infections that start as PID can even cause death.

Tell your healthcare provider right away if you have any of these signs of PID: long-lasting or heavy bleeding, unusual vaginal discharge, low abdominal (stomach area) pain, painful sex, chills, or fever.

- **Life-threatening infection.** Life-threatening infection can occur within the first few days after Skyla is placed. Call your healthcare provider immediately if you develop severe pain or fever shortly after Skyla is placed.
- **Perforation.** Skyla may become attached to (embedded) or go through the wall of the uterus. This is called perforation. If this occurs, Skyla may no longer prevent pregnancy. If perforation occurs, Skyla may move outside the uterus and can cause internal scarring, infection, or damage to other organs, and you may need surgery to have Skyla removed. The risk of perforation is increased in breastfeeding women.

Common side effects of Skyla include:

- Pain, bleeding or dizziness during and after placement. If these symptoms do not stop 30 minutes after placement, Skyla may not have been placed correctly. Your healthcare provider will examine you to see if Skyla needs to be removed or replaced.
- Expulsion. Skyla may come out by itself. This is called expulsion. Expulsion occurs in about 3 out of 100 women. You may become pregnant if Skyla comes out. If you think that Skyla has come out, use a backup birth control method like condoms and spermicide and call your healthcare provider.
- Missed menstrual periods. About 1 out of 16 women stop having periods after 1 year of Skyla use. If you do not have a period for 6 weeks during Skyla use, call your healthcare provider. When Skyla is removed, your menstrual periods will come back.
- Changes in bleeding. You may have bleeding and spotting between menstrual periods, especially during the first 3-6 months. Sometimes the bleeding is heavier than usual at first. However, the bleeding usually becomes lighter than usual and may be irregular. Call your healthcare provider if the bleeding remains heavier than usual or increases after it has been light for a while.
- Cysts on the ovary. About 14 out of 100 women using Skyla develop a cyst on the ovary. These cysts usually disappear on their own in a month or two. However, cysts can cause pain and sometimes cysts will need surgery.

This is not a complete list of possible side effects with Skyla. For more information, ask your healthcare provider.

Call your doctor for medical advice about side effects. You may report side effects to the manufacturer at 1-888-842-2937, or FDA at 1-800-FDA-1088 or www.fda.gov/medwatch.

After Skyla has been placed, when should I call my healthcare provider?

Call your healthcare provider if you have any concerns about Skyla. Be sure to call if you:

- Think you are pregnant
- Have pelvic pain or pain during sex
- Have unusual vaginal discharge or genital sores
- Have unexplained fever, flu-like symptoms or chills
- Might be exposed to sexually transmitted infections (STIs)
- Cannot feel Skyla's threads
- Develop very severe or migraine headaches
- Have yellowing of the skin or whites of the eyes. These may be signs of liver problems.
- Have had a stroke or heart attack
- Or your partner becomes HIV positive
- Have severe vaginal bleeding or bleeding that lasts a long time

General advice about prescription medicines

Medicines are sometimes prescribed for conditions that are not mentioned in patient information leaflets. This leaflet summarizes the most important information about Skyla. If you would like more information, talk with your healthcare provider. You can ask your healthcare provider for information about Skyla that is written for health providers.

For more information, go to www.skyla-us.com or call 1-888-842-2937.

This Patient Information has been approved by the U.S. Food and Drug Administration.

Revised Sept 2013

Manufactured for:

Bayer HealthCare Pharmaceuticals Inc.
Whippany, NJ 07981

© 2013, Bayer HealthCare Pharmaceuticals Inc.
All rights reserved.