

HIGHLIGHTS OF PRESCRIBING INFORMATION

These highlights do not include all the information needed to use VERSACLOZ® safely and effectively. See full prescribing information for VERSACLOZ®.

VERSACLOZ (clozapine) oral suspension
Initial U.S. Approval: 1989

WARNING: SEVERE NEUTROPENIA; ORTHOSTATIC HYPOTENSION, BRADYCARDIA, AND SYNCOPE; SEIZURE; MYOCARDITIS AND CARDIOMYOPATHY; INCREASED MORTALITY IN ELDERLY PATIENTS WITH DEMENTIA-RELATED PSYCHOSIS

See full prescribing information for complete boxed warning.

- **Severe Neutropenia:** Clozapine can cause severe neutropenia, which can lead to serious and fatal infections. Patients initiating and continuing treatment with VERSACLOZ must have a baseline blood absolute neutrophil count (ANC) measured before treatment initiation and regular ANC monitoring during treatment. (2.1, 5.1).
- **VERSACLOZ is available only through a restricted program called the Clozapine REMS (5.2).**
- **Orthostatic Hypotension, Bradycardia, and Syncope:** Risk is dose-related. Starting dose is 12.5 mg. Titrate gradually and use divided dosages (2.2, 2.6, 5.3).
- **Seizure:** Risk is dose-related. Titrate gradually and use divided doses. Use with caution in patients with history of seizure or risk factors for seizure (2.2, 5.5).
- **Myocarditis, Cardiomyopathy and Mitral Valve Incompetence:** Can be fatal. Discontinue and obtain cardiac evaluation if findings suggest these cardiac reactions (5.6).
- **Increased Mortality in Elderly Patients with Dementia-Related Psychosis:** VERSACLOZ is not approved for this condition (5.7).

RECENT MAJOR CHANGES

- Warnings and Precautions, Myocarditis, Cardiomyopathy and Mitral Valve Incompetence (5.6) 7/2020
- Warnings and Precautions, Gastrointestinal Hypomotility with Severe Complications (5.8) 2/2020
- Warnings and Precautions, Anticholinergic Toxicity (5.16) 2/2020

INDICATIONS AND USAGE

VERSACLOZ is an atypical antipsychotic indicated for:

- Treatment-resistant schizophrenia. Efficacy was established in an active controlled study (1.1, 14.1).
- Reducing suicidal behavior in patients with schizophrenia or schizoaffective disorder. Efficacy was established in an active-controlled study (1.2, 14.2).

DOSAGE AND ADMINISTRATION

- Starting Dose: 12.5 mg once daily or twice daily (2.2).
- Use cautious titration and divided dosage schedule (2.2, 5.3).
- Titration: increase the total daily dosage in increments of 25 mg to 50 mg per day, if well-tolerated (2.2).
- Target dose: 300 mg to 450 mg per day, in divided doses, by the end of 2 weeks (2.2).
- Subsequent increases: increase in increments of 100 mg or less, once or twice weekly (2.2).
- Maximum daily dose: 900 mg (2.2).
- Administer orally using syringe provided (2.3).
- Shake bottle for 10 seconds prior to withdrawing suspension from bottle; use oral syringes and syringe adaptor provided (2.3).

DOSAGE FORMS AND STRENGTHS

Oral suspension: 50 mg per mL (3).

CONTRAINDICATIONS

- Known hypersensitivity to clozapine or any other component of VERSACLOZ (4).

WARNINGS AND PRECAUTIONS

- **Gastrointestinal Hypomotility with Severe Complications:** Severe gastrointestinal adverse reactions have occurred with the use of VERSACLOZ. If constipation is identified, close monitoring and prompt treatment is advised (5.8).
- **Eosinophilia:** Assess for organ involvement (e.g., myocarditis, pancreatitis, hepatitis, colitis, nephritis). Discontinue if these occur (5.9).
- **QT Interval Prolongation:** Can be fatal. Consider additional risk factors for prolonged QT interval (disorders and drugs) (5.10).
- **Metabolic Changes:** Atypical antipsychotic drugs have been associated with metabolic changes that may increase cardiovascular/cerebrovascular risk. These metabolic changes include:
 - **Hyperglycemia and Diabetes Mellitus:** Monitor for symptoms of hyperglycemia including polydipsia, polyuria, polyphagia, and weakness. Monitor glucose regularly in patients with diabetes or at risk for diabetes (5.11).
 - **Dyslipidemia:** Undesirable alterations in lipids have occurred in patients treated with atypical antipsychotics (5.11).
 - **Weight Gain:** Significant weight gain has occurred. Monitor weight gain (5.11).
- **Neuroleptic Malignant Syndrome (NMS):** Immediately discontinue and monitor closely. Assess for co-morbid conditions (5.12).
- **Hepatotoxicity:** Can be fatal. Monitor for hepatotoxicity. Discontinue treatment if hepatitis or transaminase elevations combined with other symptoms occur (5.13).
- **Fever:** Evaluate for infection, and for neutropenia, NMS (5.14).
- **Pulmonary Embolism (PE):** Consider PE if respiratory distress, chest pain, or deep vein thrombosis occurs (5.15).
- **Anticholinergic Toxicity:** When possible, avoid use with other anticholinergic drugs and use with caution in patients with a current diagnosis or prior history of constipation, urinary retention, clinically significant prostatic hypertrophy, or other conditions in which anticholinergic effects can lead to significant adverse reactions (5.16, 7.1).
- **Interference with Cognitive and Motor Performance:** Advise caution when operating machinery, including automobiles (5.17).

ADVERSE REACTIONS

Most common adverse reactions (≥5%) were: CNS reactions (sedation, dizziness/vertigo, headache, and tremor); cardiovascular reactions (tachycardia, hypotension, and syncope); autonomic nervous system reactions (hypersalivation, sweating, dry mouth, and visual disturbances); gastrointestinal reactions (constipation and nausea); and fever (6.1).

To report SUSPECTED ADVERSE REACTIONS, contact TruPharma, LLC, at 1-877-541-5504 or FDA at 1-800-FDA-1088 or www.fda.gov/medwatch.

DRUG INTERACTIONS

- **Concomitant use of Strong CYP1A2 Inhibitors:** Reduce VERSACLOZ dose to one third when coadministered with strong CYP1A2 inhibitors (e.g., fluvoxamine, ciprofloxacin, enoxacin) (2.7, 7.1).
- **Concomitant use of Strong CYP3A4 Inducers** is not recommended (2.7, 7.1).
- **Discontinuation of CYP1A2 or CYP3A4 Inducers:** Consider reducing VERSACLOZ dose when CYP1A2 (e.g., tobacco smoke) or CYP3A4 inducers (e.g., carbamazepine) are discontinued (2.7, 7.1).
- **Anticholinergic drugs:** Concomitant use may increase the risk for anticholinergic toxicity (5.8, 5.16, 7.1).

USE IN SPECIFIC POPULATIONS

Pregnancy: May cause extrapyramidal and/or withdrawal symptoms in neonates with third trimester exposure (8.1).

See 17 for PATIENT COUNSELING INFORMATION and FDA-approved patient labeling.

Revised: 7/2020

FULL PRESCRIBING INFORMATION: CONTENTS*

WARNING: SEVERE NEUTROPENIA; ORTHOSTATIC HYPOTENSION, BRADYCARDIA, AND SYNCOPE; SEIZURE; MYOCARDITIS AND CARDIOMYOPATHY; INCREASED MORTALITY IN ELDERLY PATIENTS WITH DEMENTIA-RELATED PSYCHOSIS

1 INDICATIONS AND USAGE

- 1.1 Treatment-Resistant Schizophrenia
- 1.2 Reduction in the Risk of Recurrent Suicidal Behavior in Schizophrenia or Schizoaffective Disorders

2 DOSAGE AND ADMINISTRATION

- 2.1 Required Laboratory Testing Prior to Initiation and During Therapy
- 2.2 Dosing Information
- 2.3 Important Administration Instructions
- 2.4 Maintenance Treatment
- 2.5 Discontinuation of Treatment
- 2.6 Re-Initiation of Treatment
- 2.7 Dosage Adjustments with Concomitant use of CYP1A2, CYP2D6, CYP3A4 Inhibitors or CYP1A2, CYP3A4 Inducers
- 2.8 Renal or Hepatic Impairment, or CYP2D6 Poor Metabolizers

3 DOSAGE FORMS AND STRENGTHS

4 CONTRAINDICATIONS

5 WARNINGS AND PRECAUTIONS

- 5.1 Severe Neutropenia
- 5.2 Clozapine REMS Program
- 5.3 Orthostatic Hypotension, Bradycardia, and Syncope
- 5.4 Falls
- 5.5 Seizures
- 5.6 Myocarditis, Cardiomyopathy and Mitral Valve Incompetence
- 5.7 Increased Mortality in Elderly Patients with Dementia-Related Psychosis
- 5.8 Gastrointestinal Hypomotility with Severe Complications
- 5.9 Eosinophilia
- 5.10 QT Interval Prolongation
- 5.11 Metabolic Changes
- 5.12 Neuroleptic Malignant Syndrome
- 5.13 Hepatotoxicity
- 5.14 Fever
- 5.15 Pulmonary Embolism
- 5.16 Anticholinergic Toxicity
- 5.17 Interference with Cognitive and Motor Performance
- 5.18 Tardive Dyskinesia
- 5.19 Cerebrovascular Adverse Reactions
- 5.20 Recurrence of Psychosis and Cholinergic Rebound after Abrupt Discontinuation of VERSACLOZ

6 ADVERSE REACTIONS

- 6.1 Clinical Trials Experience
- 6.2 Postmarketing Experience

7 DRUG INTERACTIONS

- 7.1 Potential for Other Drugs to Affect VERSACLOZ
- 7.2 Potential for VERSACLOZ to Affect Other Drugs

8 USE IN SPECIFIC POPULATIONS

- 8.1 Pregnancy
- 8.2 Lactation
- 8.4 Pediatric Use
- 8.5 Geriatric Use
- 8.6 Patients with Renal or Hepatic Impairment
- 8.7 CYP2D6 Poor Metabolizers
- 8.8 Hospice Patients

10 OVERDOSAGE

- 10.1 Overdosage Experience
- 10.2 Management of Overdosage

11 DESCRIPTION

12 CLINICAL PHARMACOLOGY

- 12.1 Mechanism of Action
- 12.2 Pharmacodynamics
- 12.3 Pharmacokinetics

13 NONCLINICAL TOXICOLOGY

- 13.1 Carcinogenesis, Mutagenesis, Impairment of Fertility

14 CLINICAL STUDIES

- 14.1 Treatment-Resistant Schizophrenia
- 14.2 Recurrent Suicidal Behavior in Schizophrenia or Schizoaffective Disorder

16 HOW SUPPLIED/STORAGE AND HANDLING

- 16.1 How Supplied
- 16.2 Storage and Handling

17 PATIENT COUNSELING INFORMATION

*Sections or subsections omitted from the full prescribing information are not listed.

FULL PRESCRIBING INFORMATION

WARNING: SEVERE NEUTROPENIA; ORTHOSTATIC HYPOTENSION, BRADYCARDIA, AND SYNCOPE; SEIZURE; MYOCARDITIS AND CARDIOMYOPATHY; INCREASED MORTALITY IN ELDERLY PATIENTS WITH DEMENTIA-RELATED PSYCHOSIS

Severe Neutropenia

Clozapine treatment has caused severe neutropenia, defined as an absolute neutrophil count (ANC) less than 500/ μ L. Severe neutropenia can lead to serious infection and death. Prior to initiating treatment with VERSACLOZ a baseline ANC must be at least 1500/ μ L for the general population, and must be at least 1000/ μ L for patients with documented Benign Ethnic Neutropenia (BEN). During treatment, patients must have regular ANC monitoring. Advise patients to immediately report symptoms consistent with severe neutropenia or infection (e.g., fever, weakness, lethargy, or sore throat) [*see Dosage and Administration (2.1) and Warnings and Precautions (5.1)*].

Because of the risk of severe neutropenia, VERSACLOZ is available only through a restricted program under a Risk Evaluation Mitigation Strategy (REMS) called the Clozapine REMS Program [*see Warnings and Precautions (5.2)*].

Orthostatic Hypotension, Bradycardia, Syncope

Orthostatic hypotension, bradycardia, syncope, and cardiac arrest have occurred with clozapine treatment. The risk is highest during the initial titration period, particularly with rapid dose escalation. These reactions can occur with the first dose, with doses as low as 12.5 mg per day. Initiate treatment at 12.5 mg once or twice daily; titrate slowly; and use divided dosages. Use VERSACLOZ cautiously in patients with cardiovascular/cerebrovascular disease or conditions predisposing to hypotension (e.g., dehydration, use of antihypertensive medications) [*see Dosage and Administration (2.2, 2.6) and Warnings and Precautions (5.3)*].

Seizures

Seizures have occurred with clozapine treatment. The risk is dose-related. Initiate treatment at 12.5 mg, titrate gradually, and use divided dosing. Use caution when administering VERSACLOZ to patients with a history of seizures or other predisposing risk factors for seizure (CNS pathology, medications that lower the seizure threshold, alcohol abuse). Caution patients about engaging in any activity where sudden loss of consciousness could cause serious risk to themselves or others [*see Dosage and Administration (2.2) and Warnings and Precautions (5.5)*].

Myocarditis, Cardiomyopathy and Mitral Valve Incompetence

Fatal myocarditis and cardiomyopathy have occurred with clozapine treatment. Discontinue VERSACLOZ and obtain a cardiac evaluation upon suspicion of these reactions. Generally, patients with VERSACLOZ-related myocarditis or cardiomyopathy should not be rechallenged with VERSACLOZ. Consider the possibility of myocarditis or cardiomyopathy if chest pain, tachycardia, palpitations, dyspnea, fever, flu-like symptoms,

hypotension, or ECG changes occur [see *Warnings and Precautions (5.6)*].

Increased Mortality in Elderly Patients with Dementia-Related Psychosis

Elderly patients with dementia-related psychosis treated with antipsychotic drugs are at an increased risk of death. VERSACLOZ is not approved for use in patients with dementia-related psychosis [see *Warnings and Precautions (5.7)*].

1. INDICATIONS AND USAGE

1.1 Treatment-Resistant Schizophrenia

VERSACLOZ is indicated for the treatment of severely ill patients with schizophrenia who fail to respond adequately to standard antipsychotic treatment. Because of the risks of severe neutropenia and of seizure associated with its use, VERSACLOZ should be used only in patients who have failed to respond adequately to standard antipsychotic treatment [see *Warnings and Precautions (5.1, 5.5)*].

The effectiveness of clozapine in treatment-resistant schizophrenia was demonstrated in a 6-week, randomized, double-blind, active-controlled study comparing clozapine and chlorpromazine in patients who had failed other antipsychotics [see *Clinical Studies (14.1)*].

1.2 Reduction in the Risk of Recurrent Suicidal Behavior in Schizophrenia or Schizoaffective Disorder

VERSACLOZ is indicated for reducing the risk of recurrent suicidal behavior in patients with schizophrenia or schizoaffective disorder who are judged to be at chronic risk for re-experiencing suicidal behavior, based on history and recent clinical state. Suicidal behavior refers to actions by a patient that put him/herself at risk for death.

The effectiveness of clozapine in reducing the risk of recurrent suicidal behavior was demonstrated over a two-year treatment period in the InterSePT™ trial [see *Clinical Studies (14.2)*].

2 DOSAGE AND ADMINISTRATION

2.1 Required Laboratory Testing Prior to Initiation and During Therapy

Prior to initiating treatment with VERSACLOZ, a baseline ANC must be obtained. The baseline ANC must be at least 1500/ μ L for the general population, and at least 1000/ μ L for patients with documented Benign Ethnic Neutropenia (BEN). To continue treatment, the ANC must be monitored regularly [see *Warnings and Precautions (5.1)*].

2.2 Dosing Information

The starting dose is 12.5 mg once daily or twice daily. The total daily dose can be increased in increments of 25 mg to 50 mg per day, if well-tolerated, to achieve a target dose of 300 mg to 450 mg per day (administered in divided doses) by the end of 2 weeks. Subsequently, the dose can be increased once weekly or twice weekly, in increments of up to 100 mg. The maximum dose is 900 mg per day. To minimize the risk of orthostatic hypotension, bradycardia, and

syncope, it is necessary to use this low starting dose, gradual titration schedule, and divided dosages [see *Warnings and Precautions (5.3)*].

2.3 Important Administration Instructions

VERSACLOZ Oral Suspension is administered to the mouth by the oral syringes provided (1 mL or 9 mL). After shaking the bottle for 10 seconds prior to each use, the syringe adaptor is pressed on top of the bottle. The oral syringe (1 mL or 9 mL) is filled with air, and inserted into the adaptor. The air is dispelled into the bottle and then the bottle is turned upside down. The prescribed amount of the suspension is drawn from the bottle and dispensed directly to the mouth. The prescribed dose should be administered immediately after it is prepared. Do not draw a dose and store it in the syringe for later use. After use, the oral syringe may be washed with warm water and dried for next use. The bottle may be closed with the same cap without removing the bottle adaptor. Educate patients and caregivers on the steps to administer VERSACLOZ as described in the Patient Instructions for Use.

VERSACLOZ can be taken with or without food [see *Clinical Pharmacology (12.3)*].

2.4 Maintenance Treatment

Generally, patients responding to VERSACLOZ should continue maintenance treatment on their effective dose beyond the acute episode.

2.5 Discontinuation of Treatment

Method of treatment discontinuation will vary depending on the patient's last ANC:

- See Tables 2 or 3 for appropriate ANC monitoring based on the level of neutropenia if abrupt treatment discontinuation is necessary because of moderate to severe neutropenia.
- Reduce the dose gradually over a period of 1 to 2 weeks if termination of VERSACLOZ therapy is planned and there is no evidence of moderate to severe neutropenia.
- For abrupt clozapine discontinuation for a reason unrelated to neutropenia, continuation of the existing ANC monitoring is recommended for general population patients until their ANC is $\geq 1500/\mu\text{L}$ and for BEN patients until their ANC is $\geq 1000/\mu\text{L}$ or above their baseline.
- Additional ANC monitoring is required for any patient reporting onset of fever (temperature of 38.5°C or 101.3°F , or greater) during the 2 weeks after discontinuation [see *Warnings and Precautions (5.1)*].
- Monitor all patients carefully for the recurrence of psychotic symptoms and symptoms related to cholinergic rebound such as profuse sweating, headache, nausea, vomiting, and diarrhea.

2.6 Re-Initiation of Treatment

When restarting VERSACLOZ in patients who have discontinued VERSACLOZ (i.e., 2 days or more since the last dose), re-initiate with 12.5 mg once daily or twice daily. This is necessary to minimize the risk of hypotension, bradycardia, and syncope [see *Warnings and Precautions (5.3)*]. If that dose is well tolerated, the dose may be increased to the previously therapeutic dose more quickly than recommended for initial treatment.

2.7 Dosage Adjustments with Concomitant use of CYP1A2, CYP2D6, CYP3A4 Inhibitors or CYP1A2, CYP3A4 Inducers

Dose adjustments may be necessary in patients with concomitant use of: strong CYP1A2 inhibitors (e.g., fluvoxamine, ciprofloxacin, or enoxacin); moderate or weak CYP1A2 inhibitors (e.g., oral contraceptives, or caffeine); CYP2D6 or CYP3A4 inhibitors (e.g., cimetidine, escitalopram, erythromycin, paroxetine, bupropion, fluoxetine, quinidine, duloxetine, terbinafine, or sertraline); CYP3A4 inducers (e.g., phenytoin, carbamazepine, St. John’s wort, and rifampin); or CYP1A2 inducers (e.g., tobacco smoking) (Table 1) [see *Drug Interactions (7)*].

Table 1: Dose Adjustment in Patients Taking Concomitant Medications

Co-medications	Scenarios		
	Initiating VERSACLOZ while taking a co-medication	Adding a co-medication while taking VERSACLOZ	Discontinuing a co-medication while continuing VERSACLOZ
Strong CYP1A2 Inhibitors	Use one third of the VERSACLOZ dose.		Increase VERSACLOZ dose based on clinical response.
Moderate or Weak CYP1A2 Inhibitors	Monitor for adverse reactions. Consider reducing the VERSACLOZ dose if necessary.		Monitor for lack of effectiveness. Consider increasing VERSACLOZ dose if necessary.
CYP2D6 or CYP3A4 Inhibitors			
Strong CYP3A4 Inducers	Concomitant use is not recommended. However, if the inducer is necessary, it may be necessary to increase the VERSACLOZ dose. Monitor for decreased effectiveness.		Reduce VERSACLOZ dose based on clinical response.
Moderate or weak CYP1A2 or CYP3A4 Inducers	Monitor for decreased effectiveness. Consider increasing the VERSACLOZ dose if necessary.		Monitor for adverse reactions. Consider reducing the VERSACLOZ dose if necessary.

2.8 Renal or Hepatic Impairment, or CYP2D6 Poor Metabolizers

It may be necessary to reduce the VERSACLOZ dose in patients with significant renal or hepatic impairment, or in CYP2D6 poor metabolizers [see *Use in Specific Populations (8.6, 8.7)*].

3 DOSAGE FORMS AND STRENGTHS

VERSACLOZ is available as a free-flowing yellow oral suspension. Each mL contains 50 mg of clozapine.

4 CONTRAINDICATIONS

VERSACLOZ is contraindicated in patients with a history of serious hypersensitivity to clozapine (e.g., photosensitivity, vasculitis, erythema multiforme, or Stevens-Johnson Syndrome) or any other component of VERSACLOZ [see *Adverse Reactions (6.2)*].

5 WARNINGS AND PRECAUTIONS

5.1 Severe Neutropenia

Background

VERSACLOZ can cause neutropenia (a low absolute neutrophil count [ANC]), defined as a reduction below pre-treatment normal levels of blood neutrophils. The ANC is usually available as a component of the complete blood count (CBC), including differential, and is more relevant to drug-induced neutropenia than is the white blood cell (WBC) count. The ANC may also be calculated using the following formula: *ANC equals the Total WBC count multiplied by the total percentage of neutrophils obtained from the differential (neutrophil “segs” plus neutrophil “bands”)*. Other granulocytes (basophils and eosinophils) contribute minimally to neutropenia and their measurement is not necessary [see *Adverse Reactions (6.2)*]. Neutropenia may be mild, moderate, or severe (see Tables 2 and 3). To improve and standardize understanding, “severe neutropenia” replaces the previous terms severe leukopenia, severe granulocytopenia, or agranulocytosis.

Severe neutropenia, ANC less than (<) 500/ μ L, occurs in a small percentage of patients taking VERSACLOZ and is associated with an increase in the risk of serious and potentially fatal infections. Risk of neutropenia appears greatest during the first 18 weeks on treatment and then declines. The mechanism by which VERSACLOZ causes neutropenia is unknown and is not dose-dependent.

Two separate management algorithms are provided below, the first for patients in the general population, and the second for patients identified to have baseline neutropenia.

VERSACLOZ Treatment and Monitoring in the General Patient Population (see Table 2)

Obtain a CBC, including the ANC value, prior to initiating treatment with VERSACLOZ to ensure the presence of a normal baseline neutrophil count (equal to or greater than 1500/ μ L) and to permit later comparisons. Patients in the general population with an ANC equal to or greater than (\geq)1500/ μ L are considered within normal range (Table 2) and are eligible to initiate treatment. Weekly ANC monitoring is required for all patients during the first 6 months of treatment. If a patient’s ANC remains equal to or greater than 1500/ μ L for the first 6 months of treatment, monitoring frequency may be reduced to every 2 weeks for the next 6 months. If the ANC remains equal to or greater than 1500/ μ L for the second 6 months of continuous therapy, ANC monitoring frequency may be reduced to once every 4 weeks thereafter.

Table 2: VERSACLOZ Treatment Recommendations Based on Absolute Neutrophil Count (ANC) Monitoring for the General Patient Population

ANC Level	VERSACLOZ Treatment Recommendations	ANC Monitoring
Normal range ($\geq 1500/\mu\text{L}$)	<ul style="list-style-type: none"> Initiate treatment If treatment interrupted: <ul style="list-style-type: none"> <30 days, continue monitoring as before ≥ 30 days, monitor as if new patient 	<ul style="list-style-type: none"> Weekly from initiation to 6 months Every 2 weeks from 6 to 12 months Monthly after 12 months
	<ul style="list-style-type: none"> Discontinuation for reasons other than neutropenia 	<ul style="list-style-type: none"> See Section 2.4
Mild Neutropenia (1000 to 1499/μL)*	<ul style="list-style-type: none"> Continue treatment 	<ul style="list-style-type: none"> Three times weekly until $\text{ANC} \geq 1500/\mu\text{L}$ Once $\text{ANC} \geq 1500/\mu\text{L}$, return to patient's last "Normal Range" ANC monitoring interval**
Moderate Neutropenia (500 to 999/μL)*	<ul style="list-style-type: none"> Recommend hematology consultation Interrupt treatment for suspected clozapine-induced neutropenia Resume treatment once $\text{ANC} \geq 1000/\mu\text{L}$ 	<ul style="list-style-type: none"> Daily until $\text{ANC} \geq 1000/\mu\text{L}$, then Three times weekly until $\text{ANC} \geq 1500/\mu\text{L}$ Once $\text{ANC} \geq 1500/\mu\text{L}$, check ANC weekly for 4 weeks, then return to patient's last "Normal Range" ANC monitoring interval**
Severe Neutropenia (less than 500/μL)*	<ul style="list-style-type: none"> Recommend hematology consultation Interrupt treatment for suspected clozapine-induced neutropenia Do not rechallenge unless prescriber determines benefits outweigh risks 	<ul style="list-style-type: none"> Daily until $\text{ANC} \geq 1000/\mu\text{L}$, then Three times weekly until $\text{ANC} \geq 1500/\mu\text{L}$ If patient rechallenged, resume treatment as a new patient under "Normal Range" monitoring once $\text{ANC} \geq 1500/\mu\text{L}$

* Confirm all initial reports of ANC less than 1500/ μL with a repeat ANC measurement within 24 hours

** If clinically appropriate

VERSACLOZ Treatment and Monitoring in Patients with Benign Ethnic Neutropenia (see Table 3)

Benign ethnic neutropenia (BEN) is a condition observed in certain ethnic groups whose average ANC values are lower than "standard" laboratory ranges for neutrophils. It is most commonly observed in individuals of African descent (approximate prevalence of 25-50%), some Middle Eastern ethnic groups, and in other non-Caucasian ethnic groups with darker skin. BEN is more common in men. Patients with BEN have normal hematopoietic stem-cell number and myeloid maturation, are healthy, and do not suffer

from repeated or severe infections. They are not at increased risk for developing VERSACLOZ-induced neutropenia. Additional evaluation may be needed to determine if baseline neutropenia is due to BEN. Consider hematology consultation before initiating or during VERSACLOZ treatment as necessary.

Patients with BEN require a different ANC algorithm for VERSACLOZ management due to their lower baseline ANC levels. Table 3 provides guidelines for managing VERSACLOZ treatment and ANC monitoring in patients with BEN.

Table 3: Patients with Benign Ethnic Neutropenia (BEN); VERSACLOZ Treatment Recommendations Based on Absolute Neutrophil Count (ANC) Monitoring

ANC Level	Treatment Recommendations	ANC Monitoring
Normal BEN Range (Established ANC baseline $\geq 1000/\mu\text{L}$)	<ul style="list-style-type: none"> Obtain at least two baseline ANC levels before initiating treatment If treatment interrupted <ul style="list-style-type: none"> <30 days, continue monitoring as before ≥ 30 days, monitor as if new patient 	<ul style="list-style-type: none"> Weekly from initiation to 6 months Every 2 weeks from 6 to 12 months Monthly after 12 months
	<ul style="list-style-type: none"> Discontinuation of treatment for reasons other than neutropenia 	See Section 2.4
BEN Neutropenia (500 to $999/\mu\text{L}$)*	<ul style="list-style-type: none"> Recommend hematology consultation Continue treatment 	<ul style="list-style-type: none"> Three times weekly until ANC $\geq 1000/\mu\text{L}$ or \geq patient's known baseline Once ANC $\geq 1000/\mu\text{L}$ or at patient's known baseline, check ANC weekly for 4 weeks, then return to patient's last "Normal BEN Range" ANC monitoring interval.**
BEN Severe Neutropenia (less than $500/\mu\text{L}$)*	<ul style="list-style-type: none"> Recommend hematology consultation Interrupt treatment for suspected clozapine-induced neutropenia Do not rechallenge unless prescriber determines benefits outweigh risks 	<ul style="list-style-type: none"> Daily until ANC $\geq 500/\mu\text{L}$, then Three times weekly until ANC \geq patient's baseline If patient rechallenged, resume treatment as a new patient under "Normal Range" monitoring once ANC $\geq 1000/\mu\text{L}$ or at patient's baseline

* Confirm all initial reports of ANC less than $1500/\mu\text{L}$ with a repeat ANC measurement within 24 hours

** If clinically appropriate

General Guidelines for Management of All Patients with Fever or with Neutropenia

- Fever: Interrupt VERSACLOZ as a precautionary measure in any patient who develops fever, defined as a temperature of 38.5°C [101.3°F] or greater, and obtain an ANC level. Fever is often the first sign of neutropenic infection.
- ANC less than 1000/ μ L: If fever occurs in any patient with an ANC less than 1000/ μ L, initiate appropriate workup and treatment for infection and refer to Tables 2 or 3 for management.
- Consider hematology consultation.
- See Neuroleptic Malignant Syndrome (NMS) and Fever under WARNINGS AND PRECAUTIONS (5) and Instructions for Patients, under PATIENT COUNSELING INFORMATION (17).

Rechallenge after an ANC less than 500/ μ L (severe neutropenia)

For some patients who experience severe VERSACLOZ-related neutropenia, the risk of serious psychiatric illness from discontinuing VERSACLOZ treatment may be greater than the risk of rechallenge (e.g., patients with severe schizophrenic illness who have no treatment options other than VERSACLOZ). A hematology consultation may be useful in deciding to rechallenge a patient. In general, however, do not rechallenge patients who develop severe neutropenia with VERSACLOZ or a clozapine product.

If a patient will be rechallenged, the clinician should consider thresholds provided in Tables 2 and 3, the patient's medical and psychiatric history, a discussion with the patient and his/her caregiver about the benefits and risks of VERSACLOZ rechallenge, and the severity and characteristics of the neutropenic episode.

Using VERSACLOZ with Other Drugs Associated with Neutropenia

It is unclear if concurrent use of other drugs known to cause neutropenia increases the risk or severity of VERSACLOZ-induced neutropenia. There is no strong scientific rationale to avoid VERSACLOZ treatment in patients concurrently treated with these drugs. If VERSACLOZ is used concurrently with an agent known to cause neutropenia (e.g., some chemotherapeutic agents), consider monitoring patients more closely than the treatment guidelines provided in Tables 2 and 3. Consult with the treating oncologist in patients receiving concomitant chemotherapy.

5.2 Clozapine REMS Program

VERSACLOZ is only available through a restricted program under a REMS called the Clozapine REMS Program because of the risk of severe neutropenia.

Notable requirements of the Clozapine REMS Program include:

- Healthcare professionals who prescribe VERSACLOZ must be certified with the program by enrolling and completing training.
- Patients who receive VERSACLOZ must be enrolled in the program and comply with the ANC testing and monitoring requirements.
- Pharmacies dispensing VERSACLOZ must be certified with the program by enrolling and

- completing training and must only dispense to patients who are eligible to receive VERSACLOZ.

Further information is available at www.clozapinerems.com or 1-844-267-8678.

5.3 Orthostatic Hypotension, Bradycardia, and Syncope

Hypotension, bradycardia, syncope, and cardiac arrest have occurred with clozapine treatment. The risk is highest during the initial titration period, particularly with rapid dose-escalation. These reactions can occur with the first dose, at doses as low as 12.5 mg. These reactions can be fatal. The syndrome is consistent with neurally mediated reflex bradycardia (NMRB).

Treatment must begin at a maximum dose of 12.5 mg once daily or twice daily. The total daily dose can be increased in increments of 25 mg to 50 mg per day, if well-tolerated, to a target dose of 300 mg to 450 mg per day (administered in divided doses) by the end of 2 weeks. Subsequently, the dose can be increased weekly or twice weekly, in increments of up to 100 mg. The maximum dose is 900 mg per day. Use cautious titration and a divided dosage schedule to minimize the risk of serious cardiovascular reactions [see *Dosage and Administration (2.2)*]. Consider reducing the dose if hypotension occurs. When restarting patients who have had even a brief interval off VERSACLOZ (i.e., 2 days or more since the last dose), re-initiate treatment at 12.5 mg once daily or twice daily [see *Dosage and Administration (2.6)*].

Use VERSACLOZ cautiously in patients with cardiovascular disease (history of myocardial infarction or ischemia, heart failure, or conduction abnormalities), cerebrovascular disease, and conditions which would predispose patients to hypotension (e.g., concomitant use of antihypertensives, dehydration and hypovolemia).

5.4 Falls

VERSACLOZ may cause somnolence, postural hypotension, and motor and sensory instability, which may lead to falls and, consequently, fractures or other injuries. For patients with diseases, conditions, or medications that could exacerbate these effects, complete fall risk assessments when initiating antipsychotic treatment and recurrently for patients on long-term antipsychotic treatment.

5.5 Seizures

Seizure has been estimated to occur in association with clozapine use at a cumulative incidence at one year of approximately 5%, based on the occurrence of one or more seizures in 61 of 1743 patients exposed to clozapine during its clinical testing prior to domestic marketing (i.e., a crude rate of 3.5%). The risk of seizure is dose-related. Initiate treatment with a low dose (12.5 mg), titrate slowly, and use divided dosing.

Use caution when administering VERSACLOZ to patients with a history of seizures or other predisposing risk factors for seizure (e.g., head trauma or other CNS pathology, use of medications that lower the seizure threshold, or alcohol abuse). Because of the substantial risk of seizure associated with VERSACLOZ use, caution patients about engaging in any activity where

sudden loss of consciousness could cause serious risk to themselves or others (e.g., driving an automobile, operating complex machinery, swimming, climbing).

5.6 Myocarditis, Cardiomyopathy and Mitral Valve Incompetence

Myocarditis and cardiomyopathy have occurred with the use of clozapine. These reactions can be fatal. Discontinue VERSACLOZ and obtain a cardiac evaluation upon suspicion of myocarditis or cardiomyopathy. Generally, patients with a history of clozapine-associated myocarditis or cardiomyopathy should not be rechallenged with VERSACLOZ. However, if the benefit of VERSACLOZ treatment is judged to outweigh the potential risks of recurrent myocarditis or cardiomyopathy, the clinician may consider rechallenge with VERSACLOZ in consultation with a cardiologist, after a complete cardiac evaluation, and under close monitoring.

Consider the possibility of myocarditis or cardiomyopathy in patients receiving VERSACLOZ who present with chest pain, dyspnea, persistent tachycardia at rest, palpitations, fever, flu-like symptoms, hypotension, other signs or symptoms of heart failure, or electrocardiographic findings (low voltages, ST-T abnormalities, arrhythmias, right axis deviation, and poor R wave progression). Myocarditis most frequently presents within the first two months of clozapine treatment. Symptoms of cardiomyopathy generally occur later than clozapine-associated myocarditis and usually after 8 weeks of treatment. However, myocarditis and cardiomyopathy can occur at any period during treatment with VERSACLOZ. It is common for nonspecific flu-like symptoms such as malaise, myalgia, pleuritic chest pain, and low-grade fevers to precede more overt signs of heart failure. Typical laboratory findings include elevated troponin I or T, elevated creatinine kinase-MB, peripheral eosinophilia, and elevated C-reactive protein (CRP). Chest roentgenogram may demonstrate cardiac silhouette enlargement, and cardiac imaging (echocardiogram, radionucleotide studies, or cardiac catheterization) may reveal evidence of left ventricular dysfunction. In patients who are diagnosed with cardiomyopathy while taking clozapine mitral valve incompetence has been reported. These cases reported either mild or moderate mitral regurgitation on two-dimensional echocardiography. In patients with suspected cardiomyopathy, consider a 2D-echo Doppler examination to identify mitral valve incompetence.

5.7 Increased Mortality in Elderly Patients with Dementia-Related Psychosis

Elderly patients with dementia-related psychosis treated with antipsychotic drugs are at an increased risk of death. Analyses of 17 placebo-controlled trials (modal duration of 10 weeks), largely in patients taking atypical antipsychotic drugs, revealed a risk of death in drug-treated patients of between 1.6 to 1.7 times the risk of death in placebo-treated patients. Over the course of a typical 10-week controlled trial, the rate of death in drug-treated patients was about 4.5%, compared to a rate of about 2.6% in the placebo group. Although the causes of death were varied, most of the deaths appeared to be either cardiovascular (e.g., heart failure, sudden death) or infectious (e.g., pneumonia) in nature. Observational studies suggest that, similar to atypical antipsychotic drugs, treatment with conventional antipsychotic drugs may increase mortality in this population. The extent to which the findings of increased mortality in observational studies may be attributed to the antipsychotic drug as opposed to some characteristic(s) of the patients is not clear. VERSACLOZ is not approved for the treatment of patients with dementia-related psychosis [see *Boxed Warning*]

5.8 Gastrointestinal Hypomotility and Severe Complications

Severe gastrointestinal adverse reactions have occurred with the use of VERSACLOZ, primarily due to its potent anticholinergic effects and resulting gastrointestinal hypomotility. In post marketing experience, reported effects range from constipation to paralytic ileus. Increased frequency of constipation and delayed diagnosis and treatment increased the risk of severe complications of gastrointestinal hypomotility, resulting in intestinal obstruction, fecal impaction, megacolon and intestinal ischemia or infarction [see *Adverse Reaction (6.2)*]. These reactions have resulted in hospitalization, surgery, and death. The risk for severe adverse reactions is further increased with anticholinergic medications (and other medications that decrease gastrointestinal peristalsis); therefore, concomitant use should be avoided when possible [see *Warnings and Precautions (5.16)*, *Drug Interactions (7.1)*].

Prior to initiating VERSACLOZ, screen for constipation and treat as necessary. Subjective symptoms of constipation may not accurately reflect the degree of gastrointestinal hypomotility in VERSACLOZ treated patients. Therefore, reassess bowel function frequently with careful attention to any changes in the frequency or character of bowel movements, as well as signs and symptoms of complications of hypomotility (e.g., nausea, vomiting, abdominal distension, abdominal pain). If constipation or gastrointestinal hypomotility are identified, monitor closely and treat promptly with appropriate laxatives, as necessary, to prevent severe complications. Consider prophylactic laxatives in high risk patients.

5.9 Eosinophilia

Eosinophilia, defined as a blood eosinophil count of greater than 700/ μ L, has occurred with clozapine treatment. In clinical trials, approximately 1% of patients developed eosinophilia. Clozapine-related eosinophilia usually occurs during the first month of treatment. In some patients, it has been associated with myocarditis, pancreatitis, hepatitis, colitis, and nephritis. Such organ involvement could be consistent with a drug reaction with eosinophilia and systemic symptoms syndrome (DRESS), also known as drug induced hypersensitivity syndrome (DIHS). If eosinophilia develops during VERSACLOZ treatment, evaluate promptly for signs and symptoms of systemic reactions, such as rash or other allergic symptoms, myocarditis, or other organ-specific disease associated with eosinophilia. If clozapine-related systemic disease is suspected, discontinue VERSACLOZ immediately.

If a cause of eosinophilia unrelated to clozapine is identified (e.g., asthma, allergies, collagen vascular disease, parasitic infections, and specific neoplasms), treat the underlying cause and continue VERSACLOZ.

Clozapine-related eosinophilia has also occurred in the absence of organ involvement and can resolve without intervention. There are reports of successful rechallenge after discontinuation of clozapine, without recurrence of eosinophilia. In the absence of organ involvement, continue VERSACLOZ under careful monitoring. If the total eosinophil count continues to increase over several weeks in the absence of systemic disease, the decision to interrupt VERSACLOZ therapy and rechallenge after the eosinophil count decreases should be based on the overall clinical assessment, in consultation with an internist or hematologist.

5.10 QT Interval Prolongation

QT prolongation, Torsades de Pointes and other life-threatening ventricular arrhythmias, cardiac arrest, and sudden death have occurred with clozapine treatment. When prescribing VERSACLOZ, consider the presence of additional risk factors for QT prolongation and serious cardiovascular reactions. Conditions that increase these risks include the following: history of QT prolongation, long QT syndrome, family history of long QT syndrome or sudden cardiac death, significant cardiac arrhythmia, recent myocardial infarction, uncompensated heart failure, treatment with other medications that cause QT prolongation, treatment with medications that inhibit the metabolism of VERSACLOZ, and electrolyte abnormalities.

Prior to initiating treatment with VERSACLOZ, perform a careful physical examination, medical history, and concomitant medication history. Consider obtaining a baseline ECG and serum chemistry panel. Correct electrolyte abnormalities. Discontinue VERSACLOZ if the QTc interval exceeds 500 msec. If patients experience symptoms consistent with Torsades de Pointes or other arrhythmias, (e.g., syncope, presyncope, dizziness, or palpitations), obtain a cardiac evaluation and discontinue VERSACLOZ.

Use caution when administering concomitant medications that prolong the QT interval or inhibit the metabolism of VERSACLOZ. Drugs that cause QT prolongation include: specific antipsychotics (e.g., ziprasidone, iloperidone, chlorpromazine, thioridazine, mesoridazine, droperidol, pimozide), specific antibiotics (e.g., erythromycin, gatifloxacin, moxifloxacin, sparfloxacin), Class 1A antiarrhythmic medications (e.g., quinidine, procainamide) or Class III antiarrhythmic (e.g., amiodarone, sotalol), and others (e.g., pentamidine, levomethadyl acetate, methadone, halofantrine, mefloquine, dolasetron mesylate, probucol or tacrolimus). VERSACLOZ is primarily metabolized by CYP isoenzymes 1A2, 2D6, and 3A4. Concomitant treatment with inhibitors of these enzymes can increase the concentration of VERSACLOZ [*see Drug Interactions (7.1) and Clinical Pharmacology (12.3)*].

Hypokalemia and hypomagnesemia increase the risk of QT prolongation. Hypokalemia can result from diuretic therapy, diarrhea, and other causes. Use caution when treating patients at risk for significant electrolyte disturbance, particularly hypokalemia. Obtain baseline measurements of serum potassium and magnesium levels, and periodically monitor electrolytes. Correct electrolyte abnormalities before initiating treatment with VERSACLOZ.

5.11 Metabolic Changes

Atypical antipsychotic drugs, including VERSACLOZ, have been associated with metabolic changes that can increase cardiovascular and cerebrovascular risk. These metabolic changes include hyperglycemia, dyslipidemia, and body weight gain. While atypical antipsychotic drugs may produce some metabolic changes, each drug in the class has its own specific risk profile.

Hyperglycemia and Diabetes Mellitus

Hyperglycemia, in some cases extreme and associated with ketoacidosis or hyperosmolar coma or death, has been reported in patients treated with atypical antipsychotics including VERSACLOZ. Assessment of the relationship between atypical antipsychotic use and glucose abnormalities is complicated by the possibility of an increased background risk of diabetes

mellitus in patients with schizophrenia and the increasing incidence of diabetes mellitus in the general population. Given these confounders, the relationship between atypical antipsychotic use and hyperglycemia-related adverse reactions is not completely understood. However, epidemiological studies suggest an increased risk of treatment-emergent, hyperglycemia-related adverse reactions in patients treated with the atypical antipsychotics. Precise risk estimates for hyperglycemia-related adverse reactions in patients treated with atypical antipsychotics are not available.

Patients with an established diagnosis of diabetes mellitus who are started on VERSACLOZ should be monitored regularly for worsening of glucose control. Patients with risk factors for diabetes mellitus (e.g., obesity, family history of diabetes) who are starting treatment with atypical antipsychotics should undergo fasting blood glucose testing at the beginning of treatment and periodically during treatment. Any patient treated with atypical antipsychotics should be monitored for symptoms of hyperglycemia including polydipsia, polyuria, polyphagia, and weakness. Patients who develop symptoms of hyperglycemia during treatment with atypical antipsychotics should undergo fasting blood glucose testing. In some cases, hyperglycemia has resolved when the atypical antipsychotic was discontinued; however, some patients required continuation of anti-diabetic treatment despite discontinuation of the suspect drug.

In a pooled data analysis of 8 studies in adult subjects with schizophrenia, the mean changes in fasting glucose concentration in the clozapine and chlorpromazine groups were +11 mg/dL and +4 mg/dL respectively. A higher proportion of the clozapine group demonstrated categorical increases from baseline in fasting glucose concentrations, compared to the chlorpromazine group (Table 4). The clozapine doses were 100-900 mg per day (mean modal dose: 512 mg per day). The maximum chlorpromazine dose was 1800 mg per day (mean modal dose: 1029 mg per day). The median duration of exposure was 42 days for clozapine and chlorpromazine.

Table 4: Categorical Changes in Fasting Glucose Level in Studies in Adult Subjects with Schizophrenia

Laboratory Parameter	Category Change (at least once) from baseline	Treatment Arm	N	n (%)
Fasting Glucose	Normal (<100 mg/dL) to High (≥126 mg/dL)	Clozapine	198	53 (27)
		Chlorpromazine	135	14 (10)
	Borderline (100 to 125 mg/dL) to High (≥126 mg/dL)	Clozapine	57	24 (42)
		Chlorpromazine	43	12 (28)

Dyslipidemia

Undesirable alterations in lipids have occurred in patients treated with atypical antipsychotics, including VERSACLOZ. Clinical monitoring, including baseline and periodic follow-up lipid evaluations in patients using VERSACLOZ, is recommended

In a pooled data analysis of 10 studies in adult subjects with schizophrenia, clozapine treatment was associated with increases in serum total cholesterol. No data were collected on LDL and HDL cholesterol. The mean increase in total cholesterol was 13 mg/dL in the clozapine group and 15 mg/dL in the chlorpromazine group. In a pooled data analysis of 2 studies in adult subjects with schizophrenia, clozapine treatment was associated with increases in fasting serum triglyceride. The mean increase in fasting triglyceride was 71 mg/dL (54%) in the clozapine group and 39 mg/dL (35%) in the chlorpromazine group (Table 5). In addition, clozapine treatment was associated with categorical increases in serum total cholesterol and triglyceride, as illustrated in Table 6. The proportion of patients with categorical increases in total cholesterol or fasting triglyceride increased with the duration of exposure. The median duration of clozapine and chlorpromazine exposure was 45 days and 38 days, respectively. The clozapine dose range was 100 mg to 900 mg daily; the maximum chlorpromazine dose was 1800 mg daily.

Table 5: Mean Changes in Total Cholesterol and Triglyceride Concentration in Studies in Adult Subjects with Schizophrenia

Treatment Arm	Baseline total cholesterol concentration (mg/dL)	Change from baseline mg/dL (%)
Clozapine (N=334)	184	+13 (7)
Chlorpromazine (N=185)	182	+15 (8)
	Baseline triglyceride concentration (mg/dL)	Change from baseline mg/dL (%)
Clozapine (N=6)	130	+71 (54)
Chlorpromazine (N=7)	110	+39 (35)

Table 6: Categorical Changes in Lipid Concentrations in Studies in Adult Subjects with Schizophrenia

Laboratory Parameter	Category Change (at least once) from Baseline	Treatment Arm	N	n (%)
Total Cholesterol (random or fasting)	Increase by ≥ 40 mg/dL	Clozapine	334	111 (33)
		Chlorpromazine	185	46 (25)
	Normal (<200 mg/dL) to High (≥ 240 mg/dL)	Clozapine	222	18 (8)
		Chlorpromazine	132	3 (2)
	Borderline (200 - 239 mg/dL) to High (≥ 240 mg/dL)	Clozapine	79	30 (38)
		Chlorpromazine	34	14 (41)

Triglycerides (fasting)	Increase by ≥ 50 mg/dL	Clozapine	6	3 (50)
		Chlorpromazine	7	3 (43)
	Normal (<150 mg/dL) to High (≥ 200 mg/dL)	Clozapine	4	0 (0)
		Chlorpromazine	6	2 (33)
	Borderline (≥ 150 mg/dL and <200 mg/dL) to High (≥ 200 mg/dL)	Clozapine	1	1 (100)
		Chlorpromazine	1	0 (0)

Weight Gain

Weight gain has occurred with the use of antipsychotics, including VERSACLOZ. Monitor weight during treatment with VERSACLOZ. Table 7 summarizes the data on weight gain by the duration of exposure pooled from 11 studies with clozapine and active comparators. The median duration of exposure was 609, 728, and 42 days, in the clozapine, olanzapine, and chlorpromazine group, respectively.

Table 7: Mean Change in Body Weight (kg) by duration of exposure from studies in adult subjects with schizophrenia

Metabolic parameter	Exposure duration	Clozapine (N=669)		Olanzapine (N=442)		Chlorpromazine (N=155)	
		n	Mean	n	Mean	n	Mean
Weight change from baseline	2 weeks (Day 11 – 17)	6	+0.9	3	+0.7	2	-0.5
	4 weeks (Day 21 – 35)	23	+0.7	8	+0.8	17	+0.6
	8 weeks (Day 49 – 63)	12	+1.9	13	+1.8	16	+0.9
	12 weeks (Day 70 – 98)	17	+2.8	5	+3.1	0	0
	24 weeks (Day 154 – 182)	42	-0.6	12	+5.7	0	0
	48 weeks (Day 322 – 350)	3	+3.7	3	+13.7	0	0

Table 8 summarizes pooled data from 11 studies in adult subjects with schizophrenia demonstrating weight gain $\geq 7\%$ of body weight relative to baseline. The median duration of exposure was 609, 728, and 42 days, in the clozapine, olanzapine, and chlorpromazine group, respectively.

Table 8: Proportion of adult subjects in schizophrenia studies with weight gain $\geq 7\%$ relative to baseline body weight

Weight change	Clozapine	Olanzapine	Chlorpromazine
N	669	442	155
$\geq 7\%$ (inclusive)	236 (35%)	203 (46%)	13 (8%)

5.12 Neuroleptic Malignant Syndrome

Antipsychotic drugs including VERSACLOZ can cause a potentially fatal symptom complex referred to as Neuroleptic Malignant Syndrome (NMS). Clinical manifestations of NMS include hyperpyrexia, muscle rigidity, altered mental status, and autonomic instability (irregular pulse or blood pressure, tachycardia, diaphoresis, and cardiac dysrhythmias). Associated findings can include elevated creatine phosphokinase (CPK), myoglobinuria, rhabdomyolysis, and acute renal failure.

The diagnostic evaluation of patients with this syndrome is complicated. It is important to consider the presence of other serious medical conditions (e.g., severe neutropenia, infection, heat stroke, primary CNS pathology, central anticholinergic toxicity, extrapyramidal symptoms, and drug fever).

The management of NMS should include (1) immediate discontinuation of antipsychotic drugs and other drugs not essential to concurrent therapy, (2) intensive symptomatic treatment and medical monitoring, and (3) treatment of co-morbid medical conditions. There is no general agreement about specific pharmacological treatments for NMS.

If a patient requires antipsychotic drug treatment after recovery from NMS, the potential reintroduction of drug therapy should be carefully considered. NMS can recur. Monitor closely if restarting treatment with antipsychotics.

NMS has occurred with clozapine monotherapy and with concomitant CNS-active medications, including lithium.

5.13 Hepatotoxicity

Severe, life threatening, and in some cases fatal hepatotoxicity including hepatic failure, hepatic necrosis, and hepatitis have been reported in patients treated with clozapine [*see Adverse Reactions (6.2)*]. Monitor for the appearance of signs and symptoms of hepatotoxicity such as fatigue, malaise, anorexia, nausea, jaundice, bilirubinemia, coagulopathy, and hepatic encephalopathy. Perform serum tests for liver injury and consider permanently discontinuing treatment if hepatitis or transaminase elevations combined with other systemic symptoms are due to clozapine.

5.14 Fever

During clozapine therapy, patients have experienced transient, clozapine-related fever. The peak incidence is within the first 3 weeks of treatment. While this fever is generally benign and self-limited, it may necessitate discontinuing treatment. The fever can be associated with an increase or decrease in WBC count. Carefully evaluate patients with fever to rule out severe neutropenia or infection. Consider the possibility of NMS [*see Warnings and Precautions (5.12)*].

5.15 Pulmonary Embolism

Pulmonary embolism and deep vein thrombosis have occurred in patients treated with clozapine. Consider the possibility of pulmonary embolism in patients who present with deep vein thrombosis, acute dyspnea, chest pain, or with other respiratory signs and symptoms. Whether

pulmonary embolus and deep vein thrombosis can be attributed to clozapine or some characteristic(s) of patients is not clear.

5.16 Anticholinergic Toxicity

VERSACLOZ has potent anticholinergic effects. Treatment with VERSACLOZ can result in CNS and peripheral anticholinergic toxicity, especially at higher dosages or in overdose situations [*see Overdosage (10)*]. Use with caution in patients with a current diagnosis or prior history of constipation, urinary retention, clinically significant prostatic hypertrophy, or other conditions in which anticholinergic effects can lead to significant adverse reactions. When possible, avoid concomitant use with other anticholinergic medications because the risk for anticholinergic toxicity or severe gastrointestinal adverse reactions is increased [*see Warnings and Precautions (5.8), Drug Interactions (7.1)*].

5.17 Interference with Cognitive and Motor Performance

VERSACLOZ can cause sedation and impairment of cognitive and motor performance. Caution patients about operating hazardous machinery, including automobiles, until they are reasonably certain that VERSACLOZ does not affect them adversely. These reactions may be dose-related. Consider reducing the dose if they occur.

5.18 Tardive Dyskinesia

Tardive dyskinesia (TD) has occurred in patients treated with antipsychotic drugs, including VERSACLOZ. The syndrome consists of potentially irreversible, involuntary, dyskinetic movements. The risk of TD and the likelihood that it will become irreversible are believed to increase with greater durations of treatment and higher total cumulative doses. However, the syndrome can develop after relatively brief treatment periods at low doses. Prescribe VERSACLOZ in a manner that is most likely to minimize the risk of developing TD. Use the lowest effective dose and the shortest duration necessary to control symptoms. Periodically assess the need for continued treatment. Consider discontinuing treatment if TD occurs. However, some patients may require treatment with VERSACLOZ despite the presence of the syndrome.

There is no known treatment for TD. However, the syndrome may remit partially or completely if treatment is discontinued. Antipsychotic treatment, itself, may suppress (or partially suppress) the signs and symptoms, and it has the potential to mask the underlying process. The effect of symptom suppression on the long-term course of TD is unknown.

5.19 Cerebrovascular Adverse Reactions

In controlled trials, elderly patients with dementia-related psychosis treated with some atypical antipsychotics had an increased risk (compared to placebo) of cerebrovascular adverse reactions (e.g., stroke, transient ischemic attack), including fatalities. The mechanism for this increased risk is not known. An increased risk cannot be excluded for VERSACLOZ or other antipsychotics or other patient populations. VERSACLOZ should be used with caution in patients with risk factors for cerebrovascular adverse reaction.

5.20 Recurrence of Psychosis and Cholinergic Rebound after Abrupt Discontinuation of VERSACLOZ

If abrupt discontinuation of VERSACLOZ is necessary (because of severe neutropenia or another medical condition, for example) [see *Dosage and Administration (2.5)*, *Warnings and Precautions (5.1)*], monitor carefully for the recurrence of psychotic symptoms and adverse reactions related to cholinergic rebound, such as profuse sweating, headache, nausea, vomiting, and diarrhea.

6 ADVERSE REACTIONS

The following adverse reactions are discussed in more detail in other sections of the labeling:

- Severe Neutropenia [see *Warnings and Precautions (5.1)*].
- Orthostatic Hypotension, Bradycardia, and Syncope [see *Warnings and Precautions (5.3)*].
- Falls [see *Warnings and Precautions (5.4)*].
- Seizures [see *Warnings and Precautions (5.5)*].
- Myocarditis, Cardiomyopathy and Mitral Valve Incompetence [see *Warnings and Precautions (5.6)*].
- Increased Mortality in Elderly Patients with Dementia-Related Psychosis [see *Warnings and Precautions (5.7)*].
- Gastrointestinal Hypomotility and Severe Complications [see *Warnings and Precautions (5.8)*].
- Eosinophilia [see *Warnings and Precautions (5.9)*].
- QT Interval Prolongation [see *Warnings and Precautions (5.10)*].
- Metabolic Changes (Hyperglycemia and Diabetes Mellitus, Dyslipidemia, and Weight Gain) [see *Warnings and Precautions (5.11)*].
- Neuroleptic Malignant Syndrome [see *Warnings and Precautions (5.12)*].
- Hepatotoxicity [see *Warnings and Precautions (5.13)*].
- Fever [see *Warnings and Precautions (5.14)*].
- Pulmonary Embolism [see *Warnings and Precautions (5.15)*].
- Anticholinergic Toxicity [see *Warnings and Precautions (5.16)*].
- Interference with Cognitive and Motor Performance [see *Warnings and Precautions (5.17)*].
- Tardive Dyskinesia [see *Warnings and Precautions (5.18)*].
- Cerebrovascular Adverse Reactions [see *Warnings and Precautions (5.19)*].
- Recurrence of Psychosis and Cholinergic Rebound after Abrupt Discontinuation [see *Warnings and Precautions (5.20)*].

6.1 Clinical Trials Experience

Because clinical trials are conducted under widely varying conditions, adverse reaction rates observed in the clinical trials of a drug cannot be directly compared to rates in the clinical trials of another drug and may not reflect the rates observed in clinical practice.

The most commonly reported adverse reactions ($\geq 5\%$) across clozapine clinical trials were: CNS reactions, including sedation, dizziness/vertigo, headache, and tremor; cardiovascular reactions, including tachycardia, hypotension, and syncope; autonomic nervous system reactions, including hypersalivation, sweating, dry mouth, and visual disturbances; gastrointestinal reactions,

including constipation and nausea; and fever. Table 9 summarizes the most commonly reported adverse reactions ($\geq 5\%$) in clozapine-treated patients (compared to chlorpromazine-treated patients) in the pivotal, 6-week, controlled trial in treatment-resistant schizophrenia.

Table 9: Common Adverse Reactions ($\geq 5\%$) in the 6-Week, Randomized, Chlorpromazine-controlled Trial in Treatment-Resistant Schizophrenia

Adverse Reaction	Clozapine (N=126) (%)	Chlorpromazine (N=142) (%)
Sedation	21	13
Tachycardia	17	11
Constipation	16	12
Dizziness	14	16
Hypotension	13	38
Fever (hyperthermia)	13	4
Hypersalivation	13	1
Hypertension	12	5
Headache	10	10
Nausea/vomiting	10	12
Dry mouth	5	20

Table 10 summarizes the adverse reactions reported in clozapine-treated patients at a frequency of 2% or greater across all clozapine studies (excluding the 2-year InterSePT™ Study). These rates are not adjusted for duration of exposure.

Table 10: Adverse Reactions ($\geq 2\%$) Reported in Clozapine-treated Patients (N=842) across all Clozapine Studies (excluding the 2-year InterSePT™ Study)

Body System Adverse Reaction	Clozapine N=842 Percentage of Patients
Central Nervous System	
Drowsiness/Sedation	39
Dizziness/Vertigo	19
Headache	7
Tremor	6
Syncope	6
Disturbed Sleep/Nightmares	4
Restlessness	4
Hypokinesia/Akinesia	4
Agitation	4
Seizures (convulsions)	3 [†]
Rigidity	3
Akathisia	3
Confusion	3
Fatigue	2
Insomnia	2
Cardiovascular	
Tachycardia	25 [†]
Hypotension	9
Hypertension	4

Body System	Clozapine
Adverse Reaction	N=842
Percentage of Patients	
Gastrointestinal	
Constipation	14
Nausea	5
Abdominal Discomfort/Heartburn	4
Nausea/Vomiting	3
Vomiting	3
Diarrhea	2
Urogenital	
Urinary Abnormalities	2
Autonomic Nervous System	
Salivation	31
Sweating	6
Dry Mouth	6
Visual Disturbances	5
Skin	
Rash	2
Hemic/Lymphatic	
Leukopenia/Decreased WBC/Neutropenia	3
Miscellaneous	
Fever	5
Weight Gain	4

† Rate based on population of approximately 1700 exposed during premarket clinical evaluation of clozapine.

Table 11 summarizes the most commonly reported adverse reactions ($\geq 10\%$ of the clozapine or olanzapine group) in the InterSePT™ Study. This was an adequate and well-controlled, two-year study evaluating the efficacy of clozapine relative to olanzapine in reducing the risk of suicidal behavior in patients with schizophrenia or schizoaffective disorder. The rates are not adjusted for duration of exposure.

Table 11: Incidence of Adverse Reactions in Patients Treated with Clozapine or Olanzapine in the InterSePT™ Study ($\geq 10\%$ in the clozapine or olanzapine group)

Adverse Reactions	Clozapine N=479 % Reporting	Olanzapine N=477 % Reporting
Salivary hypersecretion	48%	6%
Somnolence	46%	25%
Weight increased	31%	56%
Dizziness (excluding vertigo)	27%	12%
Constipation	25%	10%
Insomnia	20%	33%
Nausea	17%	10%
Vomiting	17%	9%
Dyspepsia	14%	8%

Dystonia

Class effect: Symptoms of dystonia, prolonged abnormal contractions of muscle groups, may occur in susceptible individuals during the first few days of treatment. Dystonic symptoms include: spasm of the neck muscles, sometimes progressing to tightness of the throat, swallowing difficulty, difficulty breathing, and/or protrusion of the tongue. While these symptoms can occur at low doses, they occur more frequently and with greater severity with high potency and at higher doses of first generation antipsychotic drugs. An elevated risk of acute dystonia is observed in males and younger age groups.

6.2 Postmarketing Experience

The following adverse reactions have been identified during post-approval use of clozapine. Because these reactions are reported voluntarily from a population of uncertain size, it is not always possible to reliably estimate their frequency or establish a causal relationship to drug exposure.

Central Nervous System

Delirium, EEG abnormal, myoclonus, paresthesia, possible cataplexy, status epilepticus, obsessive compulsive symptoms, and post-discontinuation cholinergic rebound adverse reactions.

Cardiovascular System

Atrial or ventricular fibrillation, ventricular tachycardia, palpitations, QT interval prolongation, Torsades de Pointes, mitral valve incompetence associated with clozapine-related cardiomyopathy, myocardial infarction, cardiac arrest, and periorbital edema.

Endocrine System

Pseudopheochromocytoma.

Gastrointestinal System

Acute pancreatitis, dysphagia, salivary gland swelling, megacolon, intestinal ischemia or infarction.

Hepatobiliary System

Cholestasis, hepatitis, jaundice, hepatotoxicity, hepatic steatosis, hepatic necrosis, hepatic fibrosis, hepatic cirrhosis, liver injury (hepatic, cholestatic, and mixed), and liver failure.

Immune System Disorders

Angioedema, leukocytoclastic vasculitis.

Urogenital System

Acute interstitial nephritis, nocturnal enuresis, priapism, renal failure, and retrograde ejaculation.

Skin and Subcutaneous Tissue Disorders

Hypersensitivity reactions: photosensitivity, vasculitis, erythema multiforme, skin pigmentation disorder, and Stevens-Johnson Syndrome.

Musculoskeletal System and Connective Tissue Disorders

Myasthenic syndrome, rhabdomyolysis, and systemic lupus erythematosus.

Respiratory System

Aspiration, pleural effusion, pneumonia, lower respiratory tract infection, sleep apnea.

Hemic and Lymphatic System

Mild, moderate, or severe leukopenia, agranulocytosis, granulocytopenia, WBC decreased, deep vein thrombosis, elevated hemoglobin/hematocrit, erythrocyte sedimentation rate (ESR) increased, sepsis, thrombocytosis, and thrombocytopenia.

Vision Disorders

Narrow-angle glaucoma.

Miscellaneous

Creatine phosphokinase elevation, hyperuricemia, hyponatremia, and weight loss.

7 DRUG INTERACTIONS

7.1 Potential for Other Drugs to Affect VERSACLOZ

Clozapine is a substrate for many cytochrome P450 isozymes, in particular CYP1A2, CYP3A4, and CYP2D6. Use caution when administering VERSACLOZ concomitantly with drugs that are inducers or inhibitors of these enzymes.

CYP1A2 Inhibitors

Concomitant use of VERSACLOZ and CYP1A2 inhibitors can increase plasma levels of clozapine, potentially resulting in adverse reactions. Reduce the VERSACLOZ dose to one third of the original dose when VERSACLOZ is coadministered with strong CYP1A2 inhibitors (e.g., fluvoxamine, ciprofloxacin, or enoxacin). The VERSACLOZ dose should be increased to the original dose when coadministration of strong CYP1A2 inhibitors is discontinued [*see Dosage and Administration (2.7), Clinical Pharmacology (12.3)*].

Moderate or weak CYP1A2 inhibitors include oral contraceptives and caffeine. Monitor patients closely when VERSACLOZ is coadministered with these inhibitors. Consider reducing the VERSACLOZ dosage if necessary [*see Dosage and Administration (2.7)*].

CYP2D6 and CYP3A4 Inhibitors

Concomitant treatment with VERSACLOZ and CYP2D6 or CYP3A4 inhibitors (e.g., cimetidine, escitalopram, erythromycin, paroxetine, bupropion, fluoxetine, quinidine, duloxetine, terbinafine, or sertraline) can increase clozapine levels and lead to adverse reactions [*see Clinical Pharmacology (12.3)*]. Use caution and monitor patients closely when using such inhibitors. Consider reducing the VERSACLOZ dose [*see Dosage and Administration (2.7)*].

CYP1A2 and CYP3A4 Inducers

Concomitant treatment with drugs that induce CYP1A2 or CYP3A4 can decrease the plasma concentration of clozapine, resulting in decreased effectiveness of VERSACLOZ. Tobacco smoke is a moderate inducer of CYP1A2. Strong CYP3A4 inducers include carbamazepine, phenytoin, St. John's wort, and rifampin. It may be necessary to increase the VERSACLOZ dose if used concomitantly with inducers of these enzymes. However, concomitant use of VERSACLOZ and strong CYP3A4 inducers is not recommended [*see Dosage and Administration (2.7)*].

Consider reducing the VERSACLOZ dosage when discontinuing coadministered enzyme inducers, because discontinuation of inducers can result in increased clozapine plasma levels and an increased risk of adverse reactions [*see Dosage and Administration (2.7)*].

Anticholinergic Drugs

Concomitant treatment with clozapine and other drugs with anticholinergic activity (e.g., benztropine, cyclobenzaprine, diphenhydramine) can increase the risk for anticholinergic toxicity and severe gastrointestinal adverse reactions related to hypomotility. Avoid concomitant use of VERSACLOZ with anticholinergic drugs when possible [see *Warnings and Precautions* (5.8, 5.16)].

Drugs that Cause QT Interval Prolongation

Use caution when administering concomitant medications that prolong the QT interval or inhibit the metabolism of VERSACLOZ. Drugs that cause QT prolongation include: specific antipsychotics (e.g., ziprasidone, iloperidone, chlorpromazine, thioridazine, mesoridazine, droperidol, and pimozide), specific antibiotics (e.g., erythromycin, gatifloxacin, moxifloxacin, sparfloxacin), Class 1A antiarrhythmics (e.g., quinidine, procainamide) or Class III antiarrhythmics (e.g., amiodarone, sotalol), and others (e.g., pentamidine, levomethadyl acetate, methadone, halofantrine, mefloquine, dolasetron mesylate, probucol or tacrolimus) [see *Warnings and Precautions* (5.10)].

7.2 Potential for VERSACLOZ to Affect Other Drugs

Concomitant use of VERSACLOZ with other drugs metabolized by CYP2D6 can increase levels of these CYP2D6 substrates. Use caution when coadministering VERSACLOZ with other drugs that are metabolized by CYP2D6. It may be necessary to use lower doses of such drugs than usually prescribed. Such drugs include specific antidepressants, phenothiazines, carbamazepine, and Type 1C antiarrhythmics (e.g., propafenone, flecainide, and encainide).

8 USE IN SPECIFIC POPULATIONS

8.1 Pregnancy

Pregnancy Exposure Registry

There is a pregnancy exposure registry that monitors pregnancy outcomes in women exposed to atypical antipsychotics, including clozapine, during pregnancy. Health care providers are encouraged to register patients by contacting the National Pregnancy Registry for Atypical Antipsychotics at 1-866-961-2388 or visit <http://womensmentalhealth.org/clinical-and-research-programs/pregnancyregistry/>.

Risk Summary

Neonates exposed to antipsychotic drugs, including VERSACLOZ, during the third trimester are at risk for extrapyramidal and/or withdrawal symptoms following delivery (*see Clinical Considerations*). Overall, available data from published epidemiologic studies of pregnant women exposed to clozapine have not established a drug-associated risk of major birth defects, miscarriage, or adverse maternal or fetal outcomes (*see Data*). There are risks to the mother associated with untreated schizophrenia and with exposure to antipsychotics, including VERSACLOZ, during pregnancy (*see Clinical Considerations*).

In animal reproduction studies, no adverse developmental effects were observed when clozapine

was administered orally to pregnant rats or rabbits during the period of organogenesis, or to pregnant rats during pregnancy and lactation, at doses up to approximately 0.4 and 0.9 times the maximum recommended human dose (MRHD) of 900 mg/day, for rats and rabbits respectively, based on mg/m² body surface area (*see Data*).

The estimated background risk of major birth defects and miscarriage for the indicated populations is unknown. All pregnancies have a background risk of birth defects, loss, or other adverse outcomes. In the U.S. general population, the estimated background risk of major birth defects and miscarriage in clinically recognized pregnancies is 2 to 4% and 15 to 20%, respectively.

Clinical Considerations

Disease-associated maternal and/or embryo/fetal risk

There is a risk to the mother from untreated schizophrenia, including increased risk of relapse, hospitalization, and suicide. Schizophrenia is associated with increased adverse perinatal outcomes, including preterm birth. It is not known if this is a direct result of the illness or other comorbid factors.

Fetal/Neonatal adverse reactions

Extrapyramidal and/or withdrawal symptoms, including agitation, hypertonia, hypotonia, tremor, somnolence, respiratory distress, and feeding disorder have been reported in neonates who have been exposed to antipsychotic drugs, including VERSACLOZ, during the third trimester of pregnancy. These symptoms have varied in severity. Monitor neonates for extrapyramidal and/or withdrawal symptoms and manage symptoms appropriately. Some neonates recovered within hours or days without specific treatment; others required prolonged hospitalization.

Data

Human Data

Published data from observational studies, birth registries, and case reports on the use of atypical antipsychotics do not report a clear association with antipsychotics and major birth defects. A retrospective cohort study from a Medicaid database of 9258 women exposed to antipsychotics during pregnancy did not indicate an overall increased risk for major birth defects.

Animal Data

In embryofetal developmental studies, clozapine had no effects on maternal parameters, litter sizes, or fetal parameters when administered orally to pregnant rats and rabbits during the period of organogenesis at doses up to 0.4 and 0.9 times, respectively, the MRHD of 900 mg/day on a mg/m² body surface area basis.

In peri/postnatal developmental studies, pregnant female rats were administered clozapine over the last third of pregnancy and until day 21 postpartum. Observations were made on fetuses at

birth and during the postnatal period; the offspring were allowed to reach sexual maturity and mated. Clozapine caused a decrease in maternal body weight but had no effects on litter size or body weights of either F1 or F2 generations at doses up to 0.4 times the MRHD of 900 mg/day on a mg/m² body surface area basis.

8.2 Lactation

Risk Summary

Clozapine is present in human milk. There are reports of sedation and a report of agranulocytosis in an infant exposed to clozapine through human milk (*see Clinical Considerations*). There is no information on the effects of clozapine on milk production. The developmental and health benefits of breastfeeding should be considered along with the mother's clinical need for VERSACLOZ and any potential adverse effects on the breastfed-child from VERSACLOZ or from the underlying maternal condition.

Clinical Considerations

Infants exposed to VERSACLOZ should be monitored for excess sedation.

8.4 Pediatric Use

Safety and effectiveness in pediatric patients have not been established.

8.5 Geriatric Use

There have not been sufficient numbers of geriatric patients in clinical studies utilizing VERSACLOZ to determine whether those over 65 years of age differ from younger subjects in their response to VERSACLOZ.

Orthostatic hypotension and tachycardia can occur with clozapine treatment [*see Boxed Warning and Warnings and Precautions (5.3)*]. Elderly patients, particularly those with compromised cardiovascular functioning, may be more susceptible to these effects.

Elderly patients may be particularly susceptible to the anticholinergic effects of clozapine, such as urinary retention and constipation [*see Warnings and Precautions (5.16)*].

Carefully select VERSACLOZ doses in elderly patients, taking into consideration their greater frequency of decreased hepatic, renal, or cardiac function, as well as other concomitant disease and other drug therapy. Clinical experience suggests that the prevalence of tardive dyskinesia appears to be highest among the elderly; especially elderly women [*see Warnings and Precautions (5.18)*].

8.6 Patients with Renal or Hepatic Impairment

Dose reduction may be necessary in patients with significant impairment of renal or hepatic function. Clozapine concentrations may be increased in these patients, because clozapine is almost completely metabolized and then excreted [*see Dosage and Administration (2.8), Clinical*

Pharmacology (12.3)].

8.7 CYP2D6 Poor Metabolizers

Dose reduction may be necessary in patients who are CYP2D6 poor metabolizers. Clozapine concentrations may be increased in these patients, because clozapine is almost completely metabolized and then excreted [see *Dosage and Administration (2.8), Clinical Pharmacology (12.3)].*

8.8 Hospice Patients

For hospice patients (i.e., terminally ill patients with an estimated life expectancy of 6 months or less), the prescriber may reduce the ANC monitoring frequency to once every 6 months, after a discussion with the patient and his/her caregiver. Individual treatment decisions should weigh the importance of monitoring ANC in the context of the need to control psychiatric symptoms and the patient's terminal illness.

10 OVERDOSAGE

10.1 Overdosage Experience

The most commonly reported signs and symptoms associated with clozapine overdose are: sedation, delirium, coma, tachycardia, hypotension, respiratory depression or failure, and hypersalivation. There are reports of aspiration pneumonia, cardiac arrhythmias, and seizure. Fatal overdoses have been reported with clozapine, generally at doses above 2500 mg. There have also been reports of patients recovering from overdoses well in excess of 4 g.

10.2 Management of Overdosage

There are no specific antidotes for VERSACLOZ. Establish and maintain an airway; ensure adequate oxygenation and ventilation. Monitor cardiac status and vital signs. Use general symptomatic and supportive measures. Consider the possibility of multiple-drug involvement.

Contact a Certified Poison Control Center for the most up to date information on the management of overdosage (1-800-222-1222).

11 DESCRIPTION

VERSACLOZ, an atypical antipsychotic drug, is a tricyclic dibenzodiazepine derivative, 8-chloro-11-(4-methyl-1-piperazinyl)-5H-dibenzo[*b,e*][1,4]diazepine.

The structural formula is:

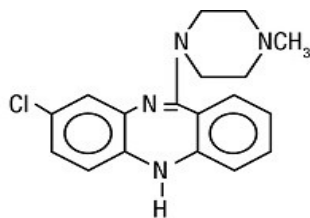

$C_{18}H_{19}ClN_4$

Mol. Wt. 326.83

VERSACLOZ is available as a free-flowing yellow suspension. Each mL contains 50 mg of clozapine.

The active component of VERSACLOZ is clozapine. The remaining components are glycerin, sorbitol (crystallizing), sodium dihydrogen phosphate dihydrate, xanthan gum, sodium methylparaben, sodium propylparaben, povidone, water, and sodium hydroxide to adjust to a pH range of 6.5 – 7.0.

12 CLINICAL PHARMACOLOGY

12.1 Mechanism of Action

The mechanism of action of clozapine is unknown. However, it has been proposed that the therapeutic efficacy of clozapine in schizophrenia is mediated through antagonism of the dopamine type 2 (D₂) and the serotonin type 2A (5-HT_{2A}) receptors. VERSACLOZ also acts as an antagonist at adrenergic, cholinergic, histaminergic and other dopaminergic and serotonergic receptors.

12.2 Pharmacodynamics

Clozapine demonstrated binding affinity to the following receptors: histamine H₁ (K_i 1.1 nM), adrenergic α_{1A} (K_i 1.6 nM), serotonin 5-HT₆ (K_i 4 nM), serotonin 5-HT_{2A} (K_i 5.4 nM), muscarinic M₁ (K_i 6.2 nM), serotonin 5-HT₇ (K_i 6.3 nM), serotonin 5-HT_{2C} (K_i 9.4 nM), dopamine D₄ (K_i 24 nM), adrenergic α_{2A} (K_i 90 nM), serotonin 5-HT₃ (K_i 95 nM), serotonin 5-HT_{1A} (K_i 120 nM), dopamine D₂ (K_i 160 nM), dopamine D₁ (K_i 270 nM), dopamine D₅ (K_i 454 nM), and dopamine D₃ (K_i 555 nM).

Clozapine causes little or no prolactin elevation.

Clinical electroencephalogram (EEG) studies demonstrated that clozapine increases delta and theta activity and slows dominant alpha frequencies. Enhanced synchronization occurs. Sharp wave activity and spike and wave complexes may also develop. Patients have reported an intensification of dream activity during clozapine therapy. REM sleep was found to be increased to 85% of the total sleep time. In these patients, the onset of REM sleep occurred almost immediately after falling asleep.

12.3 Pharmacokinetics

Absorption

In man, clozapine tablets (25 mg and 100 mg) are equally bioavailable relative to a clozapine solution. VERSACLOZ Oral Suspension is bioequivalent to clozapine marketed tablets.

Following oral administration of 100 mg to 800 mg VERSACLOZ, once daily, the average steady-state peak plasma concentration was 275 ng/mL (range: 105-723 ng/mL), occurring at the average of 2.2 hours (range: 1 to 3.5 hours) after dosing. The average minimum concentration at steady-state was 75 ng/mL (range: 11-198 ng/mL)

When VERSACLOZ was administered after a high fat meal there was no effect on the AUC_{ss} or C_{min,ss}, however C_{max} was reduced about 20%, and there was a slight delay in T_{max} of 0.5 hour from a median T_{max} of 2.0 hours under fasted conditions to 2.5 hours under fed conditions. The decrease in C_{max} is not considered clinically relevant. Therefore VERSACLOZ may be taken without regard to meals.

Distribution

Clozapine is approximately 97% bound to serum proteins. The interaction between clozapine and other highly protein-bound drugs has not been fully evaluated but may be important. [see *Drug Interactions (7)*].

Metabolism and Excretion

VERSACLOZ is almost completely metabolized prior to excretion, and only trace amounts of unchanged drug are detected in the urine and feces. VERSACLOZ is a substrate for many cytochrome P450 isozymes, in particular CYP1A2, CYP2D6, and CYP3A4. Approximately 50% of the administered dose is excreted in the urine and 30% in the feces. The demethylated, hydroxylated, and *N*-oxide derivatives are components in both urine and feces. Pharmacological testing has shown the desmethyl metabolite (norclozapine) to have only limited activity, while the hydroxylated and *N*-oxide derivatives were inactive. The mean elimination half-life of clozapine after a single 75 mg dose was 8 hours (range: 4-12 hours), compared to a mean elimination half-life of 12 hours (range: 4-66 hours), after achieving steady-state with 100 mg twice daily dosing.

A comparison of single-dose and multiple-dose administration of clozapine demonstrated that the elimination half-life increased significantly after multiple dosing relative to that after single-dose administration, suggesting the possibility of concentration-dependent pharmacokinetics. However, at steady-state, approximately dose-proportional changes with respect to AUC (area under the curve), peak, and minimum clozapine plasma concentrations were observed after administration of 37.5, 75, and 150 mg twice daily.

Drug-Drug Interaction Studies

Fluvoxamine

A pharmacokinetic study was conducted in 16 schizophrenic patients who received clozapine under steady-state conditions. After coadministration of fluvoxamine for 14 days, mean trough concentrations of clozapine and its metabolites, *N*-desmethyleclozapine and clozapine *N*-oxide, were elevated about three-fold compared to baseline steady-state concentrations.

Paroxetine, Fluoxetine, and Sertraline

In a study of schizophrenic patients (n=14) who received clozapine under steady-state conditions, coadministration of paroxetine produced only minor changes in the levels of clozapine and its metabolites. However, other published reports describe modest elevations (less than two-fold) of clozapine and metabolite concentrations when clozapine was taken with paroxetine, fluoxetine, and sertraline.

Specific Population Studies

Renal or Hepatic Impairment

No specific pharmacokinetic studies were conducted to investigate the effects of renal or hepatic impairment on the pharmacokinetics of clozapine. Higher clozapine plasma concentrations are likely in patients with significant renal or hepatic impairment when given usual doses.

CYP2D6 Poor Metabolizers

A subset (3%–10%) of the population has reduced activity of CYP2D6 (CYP2D6 poor metabolizers). These individuals may develop higher than expected plasma concentrations of clozapine when given usual doses.

13 NONCLINICAL TOXICOLOGY

13.1 Carcinogenesis, Mutagenesis, Impairment of Fertility

Carcinogenesis

No carcinogenic potential was demonstrated in long-term studies in mice and rats at doses up to 0.3 times and 0.4 times, respectively, the maximum recommended human dose (MRHD) of 900 mg/day on a mg/m² body surface area basis.

Mutagenesis

Clozapine was not genotoxic when tested in the following gene mutation and chromosomal aberration tests: the bacterial Ames test, the *in vitro* mammalian V79 in Chinese hamster cells, the *in vitro* unscheduled DNA synthesis in rat hepatocytes, or the *in vivo* micronucleus assay in mice.

Impairment of Fertility

Clozapine had no effect on any parameters of fertility, pregnancy, fetal weight, or postnatal development when administered orally to male rats 70 days before mating and to female rats for 14 days before mating at doses up to 0.4 times the MRHD of 900 mg/day on a mg/m² body surface area basis.

14 CLINICAL STUDIES

14.1 Treatment-Resistant Schizophrenia

The efficacy of clozapine in treatment-resistant schizophrenia was established in a multicenter, randomized, double-blind, active-controlled (chlorpromazine) study in patients with a DSM-III diagnosis of schizophrenia who had inadequate responses to at least 3 different antipsychotics (from at least 2 different chemical classes) during the preceding 5 years. The antipsychotic trials must have been judged adequate; the antipsychotic dosages must have been equivalent to or greater than 1000 mg per day of chlorpromazine for a period of at least 6 weeks, each without significant reduction of symptoms. There must have been no period of good functioning within

the preceding 5 years. Patients must have had a baseline score of at least 45 on the investigator-rated Brief Psychiatric Rating Scale (BPRS). On the 18-item BPRS, 1 indicates the absence of symptoms, and 7 indicates severe symptoms; the maximum potential total BPRS score is 126. At baseline, the mean BPRS score was 61. In addition, patients must have had a score of at least 4 on at least two of the following four individual BPRS items: conceptual disorganization, suspiciousness, hallucinatory behavior, and unusual thought content. Patients must have had a Clinical Global Impressions – Severity Scale score of at least 4 (moderately ill).

In the prospective, lead-in phase of the trial, all patients (N=305) initially received single-blind treatment with haloperidol (the mean dose was 61 mg per day) for 6 weeks. More than 80% of patients completed the 6-week trial. Patients with an inadequate response to haloperidol (n=268) were randomized to double-blind treatment with clozapine (N=126) or chlorpromazine (N=142). The maximum daily clozapine dose was 900 mg; the mean daily dose was >600 mg). The maximum daily chlorpromazine dose was 1800 mg; the mean daily dose was >1200 mg.

The primary endpoint was treatment response, predefined as a decrease in BPRS score of at least 20% and either (1) a CGI-S score of ≤ 3 (mildly ill), or (2) a BPRS score of ≤ 35 , at the end of 6 weeks of treatment. Approximately 88% of patients from the clozapine and chlorpromazine groups completed the 6-week trial. At the end of six weeks, 30% of the clozapine group responded to treatment, and 4% of the chlorpromazine group responded to treatment. The difference was statistically significant ($p < 0.001$). The mean change in total BPRS score was -16 and -5 in the clozapine and chlorpromazine group, respectively; the mean change in the 4 key BPRS item scores was -5 and -2 in the clozapine and chlorpromazine group, respectively; and the mean change in CGI-S score was -1.2 and -0.4, in the clozapine and chlorpromazine group, respectively. These changes in the clozapine group were statistically significantly greater than in the chlorpromazine group ($p < 0.001$ in each analysis).

14.2 Recurrent Suicidal Behavior in Schizophrenia or Schizoaffective Disorder

The effectiveness of clozapine in reducing the risk of recurrent suicidal behavior was assessed in the International Suicide Prevention Trial (InterSePT™, a trademark of Novartis Pharmaceuticals Corporation). This was a prospective, randomized, open-label, active-controlled, multicenter, international, parallel-group comparison of clozapine (Clozaril®) versus olanzapine (Zyprexa®, a registered trademark of Eli Lilly and Company) in 956 patients with schizophrenia or schizoaffective disorder (DSM-IV) who were judged to be at risk for recurrent suicidal behavior. Only about one-fourth of these patients (27%) were considered resistant to standard antipsychotic drug treatment. To enter the trial, patients must have met one of the following criteria:

- They had attempted suicide within the three years prior to their baseline evaluation.
- They had been hospitalized to prevent a suicide attempt within the three years prior to their baseline evaluation.
- They demonstrated moderate-to-severe suicidal ideation with a depressive component within one week prior to their baseline evaluation.
- They demonstrated moderate-to-severe suicidal ideation accompanied by command hallucinations to do self-harm within one week prior to their baseline evaluation.

Dosing regimens for each treatment group were determined by individual investigators and were

individualized by patient. Dosing was flexible, with a dose range of 200–900 mg/day for clozapine and 5–20 mg/day for olanzapine. For the 956 patients who received clozapine or olanzapine in this study, there was extensive use of concomitant psychotropics: 84% with antipsychotics, 65% with anxiolytics, 53% with antidepressants, and 28% with mood stabilizers. There was significantly greater use of concomitant psychotropic medications among the patients in the olanzapine group.

The primary efficacy measure was time to (1) a significant suicide attempt, including a completed suicide; (2) hospitalization due to imminent suicide risk, including increased level of surveillance for suicidality for patients already hospitalized; or (3) worsening of suicidality severity as demonstrated by “much worsening” or “very much worsening” from baseline in the Clinical Global Impression of Severity of Suicidality as assessed by the Blinded Psychiatrist (CGI-SS-BP) scale. A determination of whether or not a reported event met criterion 1 or 2 above was made by the Suicide Monitoring Board (SMB), a group of experts blinded to patient data.

A total of 980 patients were randomized to the study and 956 received study medication. Sixty-two percent of the patients were diagnosed with schizophrenia, and the remainder (38%) were diagnosed with schizoaffective disorder. Only about one-fourth of the total patient population (27%) was identified as “treatment-resistant” at baseline. There were more males than females in the study (61% of all patients were male). The mean age of patients entering the study was 37 years of age (range: 18–69). Most patients were Caucasian (71%), 15% were Black, 1% were Asian, and 13% were classified as being of “other” races.

Patients treated with clozapine had a statistically significant longer delay in the time to recurrent suicidal behavior in comparison with olanzapine. This result should be interpreted only as evidence of the effectiveness of clozapine in delaying time to recurrent suicidal behavior and not a demonstration of the superior efficacy of clozapine over olanzapine.

The probability of experiencing (1) a significant suicide attempt, including a completed suicide, or (2) hospitalization because of imminent suicide risk, including increased level of surveillance for suicidality for patients already hospitalized, was lower for clozapine patients than for olanzapine patients at Week 104: clozapine 24% versus olanzapine 32%; 95% CI of the difference: 2%, 14% (Figure 1).

Figure 1. Cumulative Probability of a Significant Suicide Attempt or Hospitalization to Prevent Suicide in Patients with Schizophrenia or Schizoaffective Disorder at High Risk of Suicidality

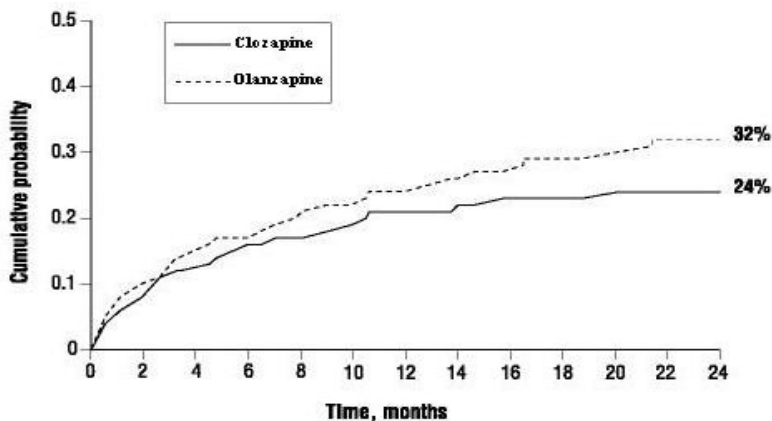

16 HOW SUPPLIED/STORAGE AND HANDLING

16.1 How Supplied

Oral Suspension

Free-flowing, yellow suspension (50 mg/mL) in amber bottle containing 100 mL. Each box contains 1 x 1 mL oral syringe, 1 x 9 mL oral syringe and 1 bottle adaptor.

NDC No. 52817-601-38

16.2 Storage and Handling

Store VERSACLOZ at or below 25°C (77°F). Do not refrigerate or freeze. Protect from light. Shake well for 10 seconds before use.

The suspension is stable for 100 days after initial bottle opening.

Keep out of reach of children.

17 PATIENT COUNSELING INFORMATION

Advise the patient to read the FDA-approved patient labeling (Patient Information and Instructions for Use). Discuss the following issues with patients and caregivers:

- Severe Neutropenia:
 - Instruct patients (and caregivers) beginning treatment with VERSACLOZ about the risk of developing severe neutropenia and infection.
 - Instruct patients to immediately report to their physician any symptom or sign of infection (e.g., flu-like illness; fever; lethargy; general weakness or malaise; mucus membrane ulceration; skin, pharyngeal, vaginal, urinary, or pulmonary infection; or extreme weakness or lethargy) occurring at any time during VERSACLOZ therapy, to aid in evaluation for neutropenia and to institute prompt and appropriate management. [see Warnings and Precautions (5.1), (5.12), and (5.14)].

- Inform patients and caregivers VERSACLOZ is available only through a restricted program called the Clozapine REMS Program designed to ensure the required blood monitoring, in order to reduce the risk of developing severe neutropenia. Advise patients and caregivers of the importance of having blood tested as follows:
 - Weekly blood tests are required for the first 6 months.
 - An ANC is required every 2 weeks for the next 6 months if an acceptable ANC is maintained during the first 6 months of continuous therapy.
 - An ANC is required once every 4 weeks thereafter if an acceptable ANC is maintained during the second 6 months of continuous therapy.
- VERSACLOZ is available only from certified pharmacies participating in the program. Provide patients (and caregivers) with website information and the telephone number on how to obtain the product [*see Warnings and Precautions (5.2)*].
- Orthostatic Hypotension, Bradycardia, and Syncope: Inform patients and caregivers about the risk of orthostatic hypotension and syncope, especially during the period of initial dose titration. Instruct them to strictly follow the clinician’s instructions for dosage and administration. Advise patients to consult their clinician immediately if they feel faint, lose consciousness or have signs or symptoms suggestive of bradycardia or arrhythmia [*see Dosage and Administration (2.2) and Warnings and Precautions (5.3)*].
- Falls: Inform patients of the risk of falls, which may lead to fractures or other injuries [*see Warnings and Precautions (5.4)*].
- Seizures: Inform patients and caregivers about the significant risk of seizure during VERSACLOZ treatment. Caution them about driving and any other potentially hazardous activity while taking VERSACLOZ [*see Warnings and Precautions (5.5)*].
- Gastrointestinal Hypomotility with Severe Complications: Educate patients and caregivers on the risks, prevention, and treatment of clozapine-induced constipation, including medications to avoid when possible (e.g., drugs with anticholinergic activity). Encourage appropriate hydration, physical activity, and fiber intake and emphasize that prompt attention and treatment to the development of constipation or other gastrointestinal symptoms is critical in preventing severe complications. Advise patients and caregivers to contact their health care provider if they experience symptoms of constipation (e.g., difficulty passing stools, incomplete passage of stool, decreased bowel movement frequency) or other symptoms associated with gastrointestinal hypomotility (e.g., nausea, abdominal distension or pain, vomiting) [*see Warnings and Precautions (5.8), Drug Interactions (7.1)*].
- QT Interval Prolongation: Advise patients to consult their clinician immediately if they feel faint, lose consciousness, or have signs or symptoms suggestive of arrhythmia. Instruct patients to not take VERSACLOZ with other drugs that cause QT interval prolongation. Instruct patients to inform their clinicians that they are taking VERSACLOZ before any new drug [*see Warnings and Precautions (5.10) and Drug Interactions (7.1)*].
- Metabolic Changes (hyperglycemia and diabetes mellitus, dyslipidemia, weight gain): Educate patients and caregivers about the risk of metabolic changes and the need for specific monitoring. The risks include hyperglycemia and diabetes mellitus, dyslipidemia, weight gain, and cardiovascular reactions. Educate patients and caregivers about the symptoms of hyperglycemia (high blood sugar) and diabetes mellitus (e.g., polydipsia,

polyuria, polyphagia, and weakness). Monitor all patients for these symptoms. Patients who are diagnosed with diabetes or have risk factors for diabetes (obesity, family history of diabetes) should have their fasting blood glucose monitored before beginning treatment and periodically during treatment. Patients who develop symptoms of hyperglycemia should have assessments of fasting glucose. Clinical monitoring of weight is recommended [*see Warnings and Precautions (5.11)*].

- ***Interference with Cognitive and Motor Performance:*** Because VERSACLOZ may have the potential to impair judgment, thinking, or motor skills, patients should be cautioned about operating hazardous machinery, including automobiles, until they are reasonably certain that VERSACLOZ therapy does not affect them adversely [*see Warnings and Precautions (5.17)*].
- ***Hepatotoxicity:*** Instruct patients to immediately report to their physician any symptoms or signs of potential liver injury (e.g. fatigue, malaise, anorexia, nausea, jaundice, bilirubinemia, coagulopathy, and hepatic encephalopathy). [*see Warnings and Precautions (5.13)*].
- ***Missed Doses and Re-Initiating Treatment:*** Inform patients and caregivers that if the patient misses taking VERSACLOZ for more than 2 days, he or she should not restart his or her medication at the same dosage but should contact their physician for dosing instructions [*see Dosage and Administration (2.6) and Warnings and Precautions (5.1, 5.3)*].
- ***Pregnancy:*** Advise pregnant women to notify their healthcare provider if they become pregnant or intend to become pregnant during treatment with VERSACLOZ. Advise patients that VERSACLOZ may cause extrapyramidal and/or withdrawal symptoms (agitation, hypertonia, hypotonia, tremor, somnolence, respiratory distress, and feeding disorder) in a neonate. Advise patients that there is a pregnancy exposure registry that monitors pregnancy outcomes in women exposed to clozapine during pregnancy [*see Use in Specific Populations (8.1)*].
- ***Lactation:*** Advise breastfeeding women using VERSACLOZ to monitor infants for excess sedation and to seek medical care if they notice this sign [*see Use in Specific Populations (8.2)*].
- ***Concomitant Medication:*** Advise patients to inform their healthcare provider if they are taking, or plan to take, any prescription or over-the-counter drugs; there is a potential for significant drug-drug interactions [*see Dosage and Administration (2.6), Drug Interactions (7.1)*].
- ***Patient Instructions for Use:*** Educate the patient and caregiver about the Patient Instructions for Use if VERSACLOZ will be administered at home. Discuss the specific steps for administering the prescribed dose using the oral syringe. [*see Dosage and Administration (2.3)*].

Distributed by:

TruPharma, LLC

Tampa, FL 33609

U.S. Patent No. 8057811

VERSACLOZ[®] is a trademark of Tasman Pharma
309939

Patient Information
VERSACLOZ® (VER sa kloz)
(clozapine)
Oral Suspension

Read this Patient Information before you start taking VERSACLOZ and each time you get a refill. There may be new information. This information does not take the place of talking to your healthcare provider about your medical condition or your treatment.

What is the most important information I should know about VERSACLOZ?
VERSACLOZ can cause serious side effects, including:

1. Severe neutropenia, a blood disorder that can lead to serious infections and death.

Severe neutropenia means that you do not have enough of certain white blood cells to fight infection. Tell your healthcare provider right away if you have any of the following symptoms or signs of neutropenia or infection:

- Skin, throat, urinary tract, vaginal, pneumonia, or any other infection
- Fever or chills
- Sores or ulcers inside your mouth, gums or on your skin
- Wounds that take a long time to heal
- Feel like you have the flu
- Pain or burning while urinating
- Unusual vaginal discharge or itching
- Abdominal pain
- Sores or pain in or around your rectal area
- Feel extremely tired or weak

If you have symptoms of severe neutropenia or infection you will need to have a blood test right away to check if VERSACLOZ is causing your symptoms. You must have frequent blood tests while taking VERSACLOZ so your healthcare provider can make sure you are not getting severe neutropenia or infection.

VERSACLOZ is available only through a restricted program called the Clozapine REMS Program. This program makes sure that **you will receive each refill of VERSACLOZ only if you have a blood test and your blood test result is acceptable to your healthcare provider.**

During your first 6 months of clozapine treatment, you will have weekly blood tests. If you have not taken clozapine before, you will need weekly blood tests when you first start VERSACLOZ. If you have acceptable blood test results during your first 6 months of clozapine treatment, you can have a blood test every other week for the next 6 months. After a year of acceptable blood test results, you can have blood tests every 4 weeks while you are taking VERSACLOZ.

2. Decreased blood pressure (orthostatic hypotension), slow heart rate (bradycardia), or fainting (syncope) that can lead to death. Lightheadedness or fainting caused by a sudden change in your heart rate and blood pressure when you rise too quickly from a sitting or lying position can happen while you take VERSACLOZ and can be life threatening. These problems may happen more often when you are first starting treatment with VERSACLOZ or when your dose is increased. Tell your healthcare provider right away if you feel faint, lose consciousness, or have symptoms of slow heart rate or an irregular heart rhythm.

3. Seizures. Seizures can occur during VERSACLOZ treatment. Be especially careful while driving or during any other dangerous activity while taking VERSACLOZ.

4. Myocarditis (heart muscle inflammation) and cardiomyopathy (heart muscle weakness) that may lead to death. Symptoms of myocarditis and cardiomyopathy include:

- chest pain
- fast heartbeat
- shortness of breath
- dizziness
- swollen legs, ankles and feet
- feel tired
- fever

5. Higher risk of death in elderly people with memory loss (dementia) or psychosis.

VERSACLOZ can increase the risk of death in elderly people who have dementia.

VERSACLOZ is not for treating psychosis in elderly people with dementia.

What is VERSACLOZ?

VERSACLOZ is a prescription antipsychotic medicine used to treat people with certain types of schizophrenia, including people who:

- are not helped by other schizophrenia medicines
- have been suicidal and may be at risk of suicidal behavior again

It is not known if VERSACLOZ is safe and effective in children.

Who should not take VERSACLOZ?

Do not take VERSACLOZ if you:

- have blood problems called neutropenia
- are allergic to clozapine or any of the ingredients in VERSACLOZ. See the end of this Patient Information Leaflet for a complete list of ingredients in VERSACLOZ.

What should I tell my healthcare provider before taking VERSACLOZ?

Before you take VERSACLOZ, tell your healthcare provider about all of your medical conditions, including if you:

- have or have had heart problems or a family history of heart problems including heart attack, heart failure, abnormal heart rhythm, or long QT syndrome
- have or have had liver or kidney problems
- have or have had seizures or epilepsy
- have or have had low levels of potassium or magnesium in your blood
- have diabetes
- have increased pressure in your eyes (glaucoma)
- have had Neuroleptic Malignant Syndrome (NMS)
- have or have had uncontrolled movements of your tongue, face, mouth, or jaw (tardive dyskinesia)
- have or have had diarrhea or constipation
- have or have had an enlarged prostate gland
- smoke tobacco
- plan to stop smoking tobacco while taking VERSACLOZ
- use products containing caffeine

- are pregnant or plan to become pregnant. It is not known if VERSACLOZ will harm your unborn baby. Talk to your healthcare provider if you become pregnant while taking VERSACLOZ.
 - If you become pregnant while receiving clozapine, talk to your healthcare provider about registering with the National Pregnancy Registry for Atypical Antipsychotics. You can register by calling 1-866-961-2388 or go to <http://womensmentalhealth.org/clinical-and-research-programs/pregnancyregistry/>
- are breast feeding or plan to breast feed. VERSACLOZ can pass into your breast milk. Talk to your healthcare provider about the best way to feed your baby if you take VERSACLOZ.

Tell your healthcare provider about all the medicines you take, including prescription and non-prescription medicines, vitamins, and herbal supplements.

VERSACLOZ and other medicines may affect each other causing side effects.

Especially tell your healthcare provider if you take:

- chemotherapy, radiation, or other medicines that cause agranulocytosis, neutropenia, low white blood cell count, or affect your bone marrow
- other antipsychotics or other medicines that can affect the amount of clozapine in your blood
- medicines used to treat anxiety, relax your muscles, or help you sleep
- any medicines that make you feel sleepy
- antibiotics
- medicines used to treat heart problems
- medicines used to lower the amount of water in your body (diuretics)
- medicines used for birth control

Ask your healthcare provider for a list of these medicines if you are not sure.

Know the medicines you take. Keep a list of them to show your healthcare provider and pharmacist when you get a new medicine.

How should I take VERSACLOZ?

- Read the “**Instructions for Use**” at the end of this Patient Information for specific information about the right way to use VERSACLOZ.
- Your pharmacist should go over the instructions for how to use VERSACLOZ with you when you receive your first prescription.
- Take VERSACLOZ exactly as your healthcare provider tells you to take it. Talk to your healthcare provider or pharmacist if you are not sure how to take VERSACLOZ.
- Do not change your dose or stop taking VERSACLOZ without talking to your healthcare provider.

The symptoms of VERSACLOZ overdose can include:

- feeling sleepy
- seizures
- confusion
- coma
- fast or irregular heartbeat
- low blood pressure
- shallow or difficult breathing
- having a lot of saliva in your mouth

If you miss a dose of VERSACLOZ for more than 2 days, check with your healthcare provider before starting to take it again to make sure you take the correct dose.

What should I avoid while taking VERSACLOZ?

- You should not drink alcohol while taking VERSACLOZ. It can increase your chances of getting serious side effects.
- Do not drive, operate machinery, swim, climb, or do other dangerous activities until you know how VERSACLOZ affects you.

What are the possible side effects of VERSACLOZ?

VERSACLOZ may cause serious side effects, including:

- See "**What is the most important information I should know about VERSACLOZ?**"
- **severe constipation and bowel problems.** You may not feel or be aware of constipation symptoms. Contact your healthcare provider if you are having bowel movements at less than your normal frequency, especially if it is less than three times a week, you have hard or dry stools, or you have difficulty passing gas. Talk with your healthcare provider about ways to prevent constipation. Other symptoms associated with bowel problems include nausea, bloating or stomach swelling, stomach pain, and vomiting.
- **high count of a certain white blood cell (eosinophilia)**
- **problems with your heartbeat. These heart problems can cause death. Call your healthcare provider right away if you have any of these symptoms:**
 - passing out or feeling like you will pass out
 - dizziness
 - feeling as if your heart is pounding or missing beats
- **high blood sugar (diabetes) and changes in the fat levels in your blood (dyslipidemia)**
- **Neuroleptic Malignant Syndrome (NMS).** NMS is a rare but very serious problem that can happen in people who take VERSACLOZ. NMS can cause death and must be treated in a hospital. Call your healthcare provider right away if you become severely ill and have any of these symptoms:
 - high fever
 - excessive sweating
 - stiff muscles
 - confusion
 - changes in your breathing, heartbeat and blood pressure
- **falls.** May lead to fractures or other injuries
- **liver problems.** Call your healthcare provider right away if you have any of these symptoms:

- nausea
 - vomiting
 - loss of appetite
 - feel tired
 - pain on the right side of your stomach (abdomen)
 - yellowing of your skin or the whites of your eyes
- **fever.** Some people may have a fever that comes and goes while they take VERSACLOZ. This happens more often in the first 3 weeks you take VERSACLOZ. Talk to your healthcare provider if you have a fever.
 - **blood clot in your lung (pulmonary embolism) or in the veins of your legs (deep vein thrombosis).** Get emergency help right away if you have symptoms of a blood clot including:
 - chest pain and shortness of breath
 - swelling or pain in your leg, ankle or foot
 - warm feeling in the skin of your affected leg
 - changes in your skin color such as turning pale or blue
 - **a problem that includes dry mouth, increased sweating, increased pulse rate and constipation (anticholinergic toxicity)**
 - **problems thinking clearly and moving your body**
 - **uncontrolled movements of your tongue, face, mouth, or jaw (tardive dyskinesia)**
 - **stroke in elderly people (cerebrovascular problems)**

The most common side effects of VERSACLOZ include:

- sleepiness or drowsiness
- dizziness
- heart and blood vessel problems
- fast heartbeat
- passing out (syncope)
- increased sweating
- vision problems
- headache
- shaking movements (tremors)
- low blood pressure
- having a lot of saliva in your mouth
- dry mouth
- stomach and intestinal problems
- nausea

Tell your healthcare provider if you have any side effect that bothers you or that does not go away.

These are not all the possible side effects of VERSACLOZ. For more information, ask your healthcare provider or pharmacist.

Call your doctor for medical advice about side effects. You may report side effects to FDA at 1-800-FDA-1088.

How should I store VERSACLOZ?

- Store VERSACLOZ at room temperature between 68°F to 77°F (20°C to 25°C).
- Do not refrigerate or freeze VERSACLOZ.
- Protect VERSACLOZ from light.
- Shake your VERSACLOZ bottle well for 10

seconds before each use. **Keep VERSACLOZ and all medicines out of the reach of children.**

General information about the safe and effective use of VERSACLOZ

Medicines are sometimes prescribed for purposes other than those listed in a Patient Information Leaflet. Do not use VERSACLOZ for a condition for which it was not prescribed. Do not give VERSACLOZ to other people, even if they have the same symptoms that you have. It may harm them.

This Patient Information Leaflet summarizes the most important information about VERSACLOZ. If you would like more information, talk with your healthcare provider. You can ask your pharmacist or healthcare provider for more information about VERSACLOZ that is written for healthcare professionals.

For more information, go to www.VERSACLOZ.com or call 1-800-520-5568.

What are the ingredients in VERSACLOZ?

Active ingredient: clozapine

Inactive ingredients: glycerin, sorbitol (crystallizing), sodium dihydrogen phosphate dihydrate, xanthan gum, sodium methylparaben, sodium propylparaben, povidone, water, and sodium hydroxide

Instructions for Use
VERSACLOZ[®] (VER sa kloz)
(clozapine)
Oral Suspension

Supplies you will need to take your VERSACLOZ dose:

- VERSACLOZ[®] Oral Suspension bottle
- a bottle neck adaptor
- the correct oral syringe to measure your dose
 - **If your dose is 1 mL (50 mg) or less**, use the smaller 1 mL oral syringe.
 - **If your dose is more than 1 mL (50 mg)**, use the larger 9 mL oral syringe.

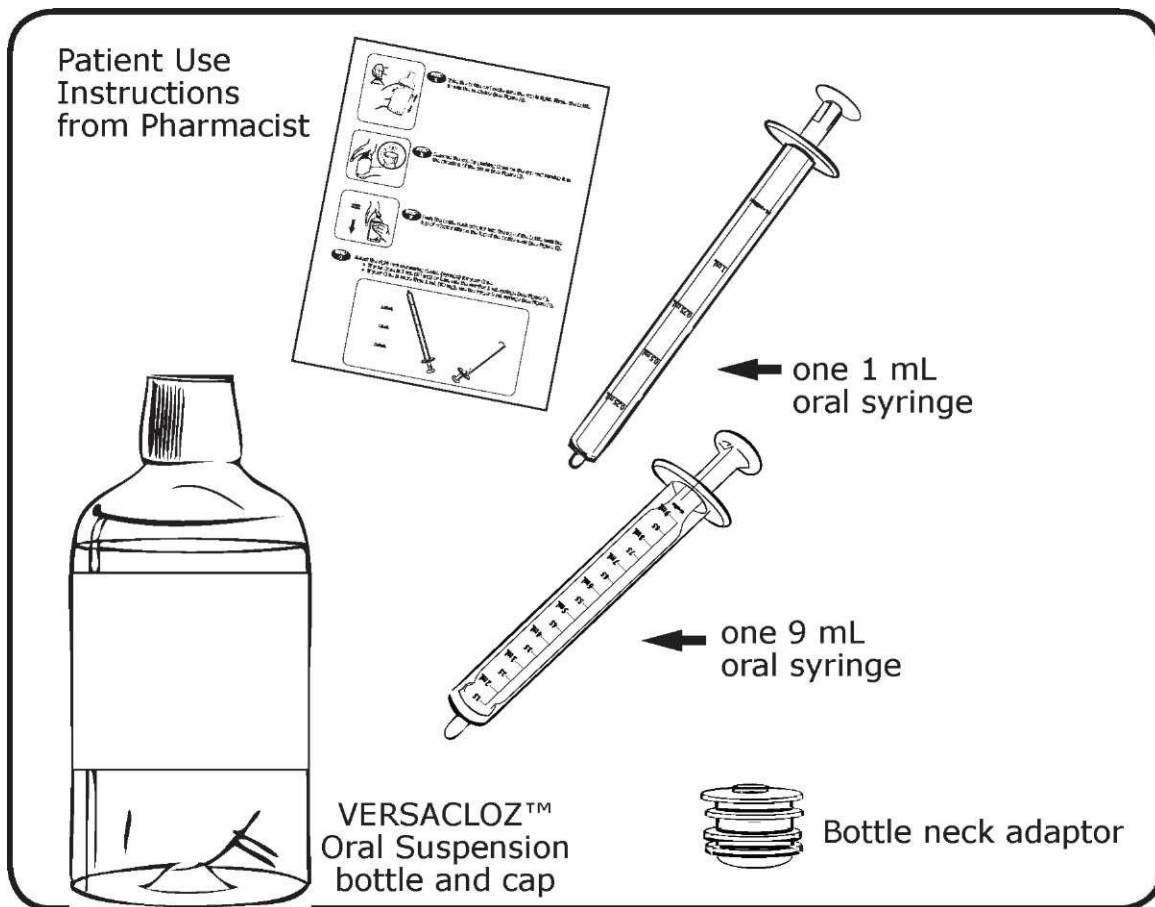



Step 1 Make sure the cap is tight on the VERSACLOZ bottle by turning the cap clockwise. Shake the bottle up and down for 10 seconds before use. (see Figure A)

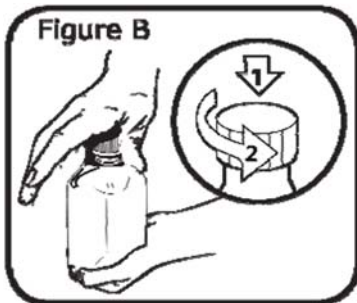

Step 2 Remove the bottle cap by **pushing down on the cap** and then turning it counterclockwise. (see Figure B)

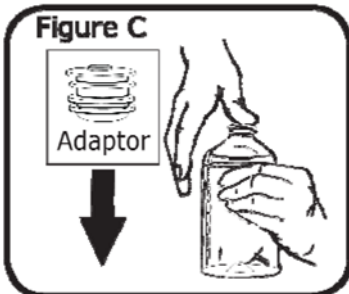

Step 3 **The first time you open a new bottle**, push the adaptor into the bottle until the top of the adaptor is lined up with the top of the bottle. (see Figure C)

Select the correct oral syringe to measure your dose of VERSACLOZ as your pharmacist showed you.

If your dose is 1 mL (50 mg) or less, use the smaller 1 mL oral syringe. (see Figure D)

If your dose is more than 1 mL (50 mg), use the larger 9 mL oral syringe. (see Figure D)

Step 4

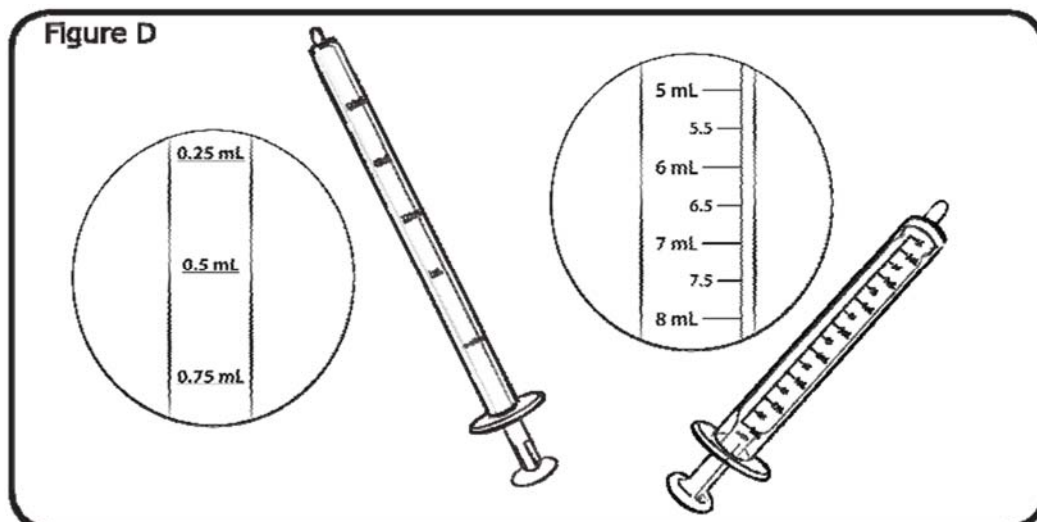

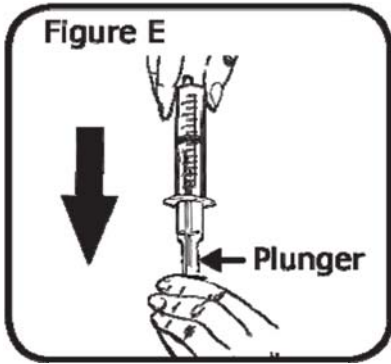

Step 5 Fill the oral syringe with air by drawing back the plunger. (see Figure E)

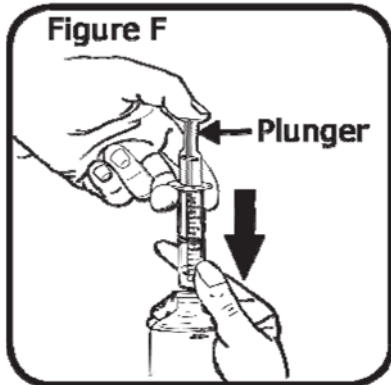

Step 6 Insert the open tip of the oral syringe into the bottle neck adaptor. Push all the air from the oral syringe into the bottle by pushing down on the plunger. (see Figure F)

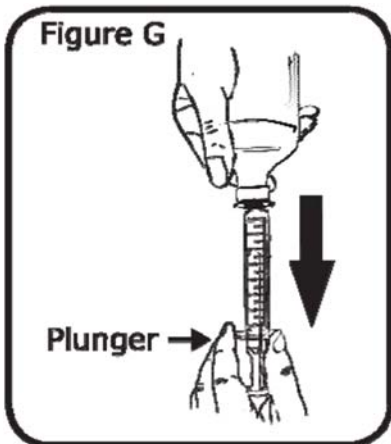

Step 7 While holding the oral syringe in place, carefully turn the bottle upside down. Draw some of the medicine out of the bottle into the oral syringe by pulling back on the plunger. Be careful not to pull the plunger all the way out. (see Figure G)

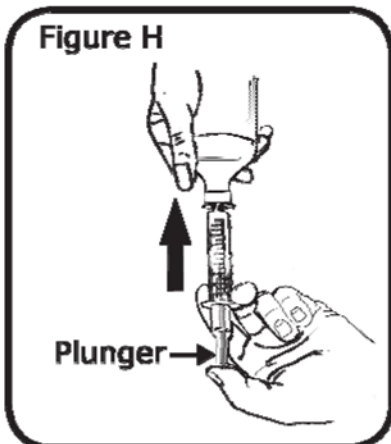

Step 8 You will see a small amount of air near the end of the plunger in the oral syringe. Push on the plunger so the medicine goes back into the bottle and the air disappears. (see Figure H)

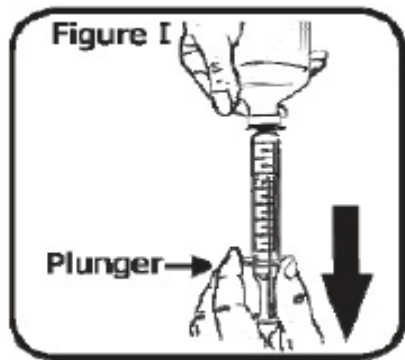

Step
9

Pull back on the plunger to draw your correct dose of medicine into the oral syringe. (see Figure I)

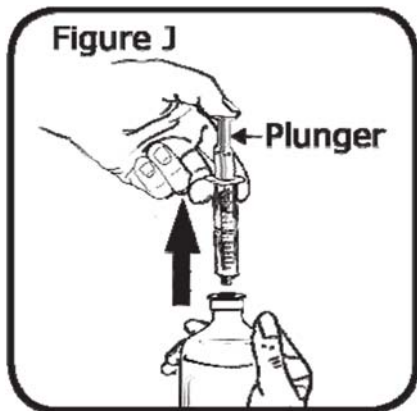

Step
10

While still holding the oral syringe in the bottle, carefully turn the bottle upwards so the syringe is on top. Remove the oral syringe from the bottle neck adaptor without pushing on the plunger. (see Figure J)

Take your medicine as soon as you draw it into the oral syringe. Do not store the medicine in the oral syringe for later use.

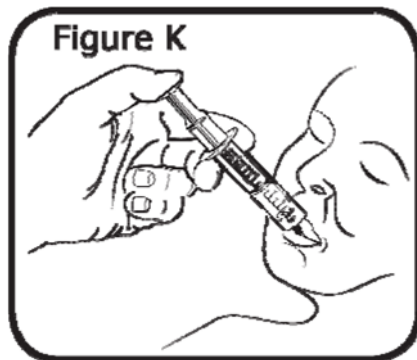

Step
11

Put the open tip of the oral syringe into 1 side of your mouth (see Figure K). Close your lips around the oral syringe as tightly as you can. Push on the plunger **slowly** so the liquid goes into your mouth. Swallow the medicine **slowly** as it goes into your mouth.

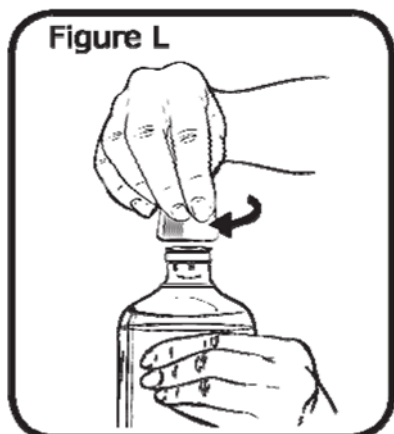

Step
12

Leave the bottle neck adaptor in the bottle. Put the cap back on the bottle and turn it clockwise to tighten it. (see Figure L)

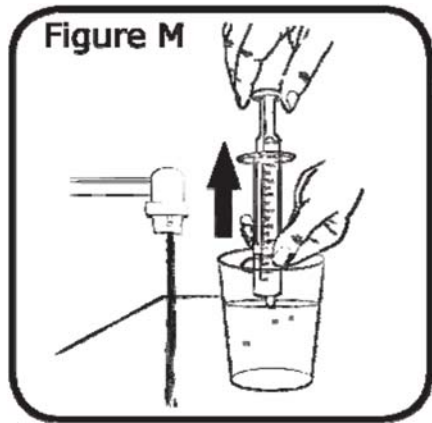

Step
13

Rinse the oral syringe with warm tap water after each use. Fill a cup with water. Put the tip of the oral syringe into the water in the cup, pull back on the plunger and draw the water into the oral syringe. (see Figure M)

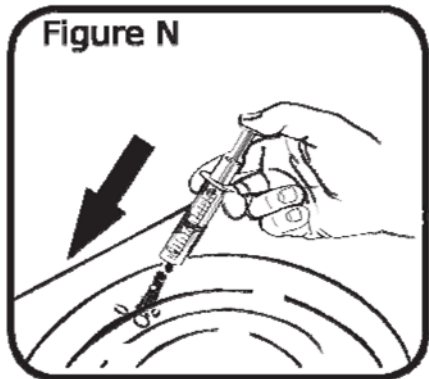

Step
14

Push on the plunger to squirt the water into a sink or a separate container. (see Figure N)
Repeat Step 13 until the oral syringe is clean. Let the oral syringe air dry. Throw away any leftover rinse water.

Disposal of your oral syringe, empty VERSACLOZ bottle and bottle neck adaptor:

Place the cap back on the empty VERSACLOZ bottle before you throw it away. The oral syringe, empty bottle and bottle neck adaptor should be placed in your household trash when you finish your bottle of VERSACLOZ. The oral syringe should not be shared with other people or used for medicines other than VERSACLOZ.

Distributed by:
TruPharma, LLC
Tampa, FL 33609

This Patient Information and the Instructions for Use have been approved by the U.S. Food and Drug Administration.

309939

Revised: January 2018