

Batch No.
EXP
BU174 00 V6 060520

<p>Drug Facts (continued)</p> <p>Directions ■ adults 18 years of age and older ■ this product is to be used once a day (every 24 hours), every day for 14 days ■ it may take 1 to 4 days for full effect, although some people get complete relief of symptoms within 24 hours</p> <p>14-Day Course of Treatment ■ take 1 tablet before eating in the morning ■ do not crush or chew tablets ■ place the tablet on tongue; tablet disintegrates, with or without water. The tablets can also be swallowed whole with water. ■ take every day for 14 days ■ do not take more than 1 tablet a day ■ do not use for more than 14 days unless directed by your doctor ■ do not take this medicine with alcohol</p> <p>Repeated 14-Day Course (if needed) ■ you may repeat a 14-day course every 4 months ■ do not take for more than 14 days or more often than every 4 months unless directed by a doctor</p> <p>Other information ■ children under 18 years of age: ask a doctor before use. Heartburn in children may sometimes be caused by a serious condition. ■ read the directions, warnings and package insert before use ■ keep the carton and package insert. They contain important information. ■ store at 20-25°C (68-77°F) ■ keep product out of high heat and humidity ■ protect product from moisture</p> <p>Inactive ingredients ascorbic acid, cetyl alcohol, colloidal silicon dioxide, copovidone, croscopolone, flavor, hypromellose, hypromellose phthalate, maize maltoedextrin, maltitol, mannitol, magnesium, microcrystalline cellulose, polyosorbate 80, polypropylene glycol, silicon dioxide, sodium stearyl fumarate, sorbitol, sucralose, sugar spheres, talc, titanium dioxide, triethyl citrate</p> <p>Questions or comments? 1-800-719-9260; weekdays 7:30 AM to 5:00 PM EST</p>	<p>Drug Facts</p> <p>Active ingredient (in each tablet).....Lansoprazole 15 mgAcid Reducer</p> <p>Use ■ treats frequent heartburn (occurs 2 or more days a week) ■ not intended for immediate relief of heartburn; this drug may take 1 to 4 days for full effect</p> <p>Warnings Allergy alert: do not use if you are allergic to lansoprazole ■ if you have trouble or pain swallowing food, vomiting with blood, or bloody or black stools. These may be signs of a serious condition. See your doctor. Ask a doctor before use if you have ■ had heartburn over 3 months. This may be a sign of a more serious condition. ■ heartburn with lightheadedness, sweating or dizziness ■ chest pain or shoulder pain with shortness of breath; sweating; pain spreading to arms, neck or shoulders; or lightheadedness ■ frequent wheezing, particularly with heartburn ■ unexplained weight loss ■ nausea or vomiting ■ stomach pain</p> <p>Ask a doctor or pharmacist before use if you are taking a prescription drug. Acid reducers may interact with certain prescription drugs.</p> <p>Stop use and ask a doctor if ■ your heartburn continues or worsens ■ you need to take this product for more than 14 days ■ you need to take more than 1 course of treatment every 4 months ■ you get diarrhea ■ you develop a rash or joint pain</p> <p>If pregnant or breast-feeding, ask a health care professional before use. In case of overdose, get medical help or contact a Poison Control Center right away (1-800-222-1222).</p>
--	---

Location for lot number and expiration date

NOT FOR RESALE KEEP THE CARTON AND PACKAGE INSERT. THEY CONTAIN IMPORTANT INFORMATION. **Safety Feature – Do not use if printed tablet blister unit is open or torn.**

Compare to the active ingredient in Prevacid® 24 HR*



Treats Frequent Heartburn **24HR**

Lansoprazole

Delayed Release Orally Disintegrating Tablets 15 mg / Acid Reducer

DISSOLVE TABS

Melts in your mouth
Dissolves without water



14 TABLETS One 14-day course of treatment
May take 1 to 4 days for full effect



STANDARD FORMAT

TYPE SIZES:
TITLE: 9 pt Helvetica Neue LT Std 77 Bold Condensed Oblique
 TITLE (continued): 8 pt Helvetica Neue LT Std 77 Bold Condensed Oblique (continued) 8 pt Helvetica Neue LT Std 57 Condensed
HEADINGS: 8 pt Helvetica Neue LT Std 77 Bold Condensed Oblique
SUBHEADINGS: 6 pt Helvetica Neue LT Std 77 Bold Condensed
TEXT: 6 pt Helvetica Neue LT Std 57 Condensed
LEADING: 6.5 pt
BULLETS: 5 pt Square with 2 M'S spacing between statements
TELEPHONE #: 6 pt Helvetica Neue LT Std 77 Bold Condensed
HEAVY LINES: 1.5 pt
HAIRLINES: 0.5 pt
 Hairlines extend to within two spaces of the "Drug Facts" box

Made in Israel

Manufactured by:
Cexcel Pharma Technologies Ltd
10 Hakdima Street, Yokneam 2069200, Israel

*This product is not manufactured or distributed by Takeda Pharmaceuticals U.S.A., Inc., owner of the registered trademark Prevacid®.

5:00 PM EST

Questions or comments? 1-800-779-9260, weekdays 7:30 AM to 5:00 PM EST

Inactive ingredients ascorbic acid, cetyl alcohol, colloidal silicon dioxide, copovidone, croscopolone, flavor, hypromellose, hypromellose phthalate, poly sorbate 80, propylene glycol, silicon dioxide, sodium stearyl fumarate, sorbitol, sucralose, sugar spheres, talc, titanium dioxide, triethyl citrate

■ protect product from moisture
■ store at 20-25°C (68-77°F) ■ keep product out of high heat and humidity.
■ keep the carton and package insert. They contain important information.
■ read the directions, warnings and package insert before use

Other information

■ children may sometimes be caused by a serious condition.
■ children under 18 years of age, ask a doctor before use. Heartburn in 4 months unless directed by a doctor
■ do not take for more than 14 days or more often than every 4 months
■ you may repeat a 14-day course every 4 months
Repeated 14-Day Course (if needed)
■ do not take this medicine with alcohol
■ do not take for more than 14 days unless directed by your doctor
■ take every day for 14 days
The tablets can also be swallowed whole with water.
■ place the tablet on tongue; tablet disintegrates, with or without water.
■ do not crush or chew tablets
■ take 1 tablet before eating in the morning

14-Day Course of Treatment

■ relief of symptoms within 24 hours
■ it may take 1 to 4 days for full effect, although some people get complete relief of symptoms within 24 hours
■ this product is to be used once a day (every 24 hours), every day for 14 days
■ adults 18 years of age and older

Directions ■ adults 18 years of age and older

Drug Facts (continued)

Drug Facts

Active ingredient (in each tablet) Lansoprazole 15 mg.....Acid Reducer

Use ■ treats frequent heartburn (occurs 2 or more days a week)
■ not intended for immediate relief of heartburn; this drug may take 1 to 4 days for full effect

Warnings
do not use if you are allergic to lansoprazole

■ if you have trouble or pain swallowing food, vomiting with blood, or bloody or black stools; these may be signs of a serious condition. See your doctor.
■ Ask a doctor before use if you have

■ had heartburn over 3 months. This may be a sign of a more serious condition.
■ heartburn with lightheadedness, sweating or dizziness
■ chest pain or shoulder pain with shortness of breath, sweating, pain spreading to arms, neck or shoulders, or lightheadedness
■ frequent chest pain
■ frequent wheezing, particularly with heartburn
■ unexplained weight loss
■ nausea or vomiting ■ stomach pain

Ask a doctor or pharmacist before use if you are taking a prescription drug. Acid reducers may interact with certain prescription drugs.

Stop use and ask a doctor if

■ your heartburn continues or worsens
■ you need to take this product for more than 14 days
■ you need to take more than 1 course of treatment every 4 months
■ you get diarrhea ■ you develop a rash or joint pain

If pregnant or breast-feeding, ask a health care professional before use.
Keep out of reach of children. In case of overdose, get medical help or contact a Poison Control Center right away (1-800-222-1222).

Location for lot number and expiration date

8U174 FA C7 081320



KEEP THE CARTON AND PACKAGE INSERT. THEY CONTAIN IMPORTANT INFORMATION.

Safety Feature – Do not use if printed tablet blister unit is open or torn.

NDC 64239-181-01

Treats Frequent Heartburn

24 HR

Lansoprazole

Delayed Release
Orally Disintegrating Tablets 15 mg
Acid Reducer

May take 1 to 4 days for full effect

Dissolve Tabs

14 TABLETS ONE 14-DAY COURSE OF TREATMENT

MELTech™
Melts In Your Mouth

Compare to the active ingredient in Prevacid® 24 HR*



Strawberry Flavor



Actual size

STANDARD FORMAT

TYPE SIZES:
TITLE: 9 pt Helvetica Neue LT Std 77 Bold Condensed Oblique
TITLE (continued): 8 pt Helvetica Neue LT Std 77 Bold Condensed Oblique (continued) 8 pt Helvetica Neue LT Std 57 Condensed
HEADINGS: 8 pt Helvetica Neue LT Std 77 Bold Condensed Oblique
SUBHEADINGS: 6 pt Helvetica Neue LT Std 77 Bold Condensed
TEXT: 6 pt Helvetica Neue LT Std 57 Condensed
LEADING: 6.5 pt
BULLETS: 5 pt Square with 2 M'S spacing between statements
TELEPHONE #: 6 pt Helvetica Neue LT Std 77 Bold Condensed
HEAVY LINES: 1.5 pt
HAIRLINES: 0.5 pt
 Hairlines extend to within two spaces of the "Drug Facts" box

Made in Israel
Manufactured by:
Cexcal Pharma Technologies Ltd
10 Hakdama Street, Yokneam 2089200, Israel

*This product is not manufactured or distributed by Takeda Pharmaceuticals U.S.A., Inc., owner of the registered trademark Prevacid®.

5:00 PM EST

Questions or comments? 1-800-719-9260; weekdays 7:30 AM to 5:00 PM EST

Keep out of reach of children. In case of overdose, get medical help or contact a Poison Control Center right away (1-800-222-1222).

If pregnant or breast-feeding, ask a health care professional before use. ■ you get diarrhea ■ you develop a rash or joint pain

■ you need to take more than 1 course of treatment every 4 months

■ you need to take this product for more than 14 days

■ your heartburn continues or worsens

Stop use and ask a doctor if

Ask a doctor or pharmacist before use if you are taking a prescription drug. Acid reducers may interact with certain prescription drugs.

■ nausea or vomiting ■ stomach pain

■ frequent chest pain

■ frequent wheezing, particularly with heartburn

■ spreading to arms, neck, or shoulders; or lightheadedness

■ chest pain or shoulder pain with shortness of breath; sweating; pain

■ heartburn with lightheadedness, sweating or dizziness

■ had heartburn over 3 months. This may be a sign of a more serious condition.

■ liver disease

Ask a doctor before use if you have

■ if you have trouble or pain swallowing food; vomiting with blood, or bloody or black stools; These may be signs of a serious condition. See your doctor.

Do not use

Warnings
do not use if you are allergic to lansoprazole

1 to 4 days for full effect

Use ■ treats frequent heartburn (occurs 2 or more days a week)
■ not intended for immediate relief of heartburn; this drug may take 1 to 4 days for full effect

Active ingredient (in each tablet) Lansoprazole 15 mg.....Acid Reducer

Purpose Acid Reducer

Directions ■ adults 18 years of age and older ■ this product is to be used once a day (every 24 hours), every day for 14 days ■ it may take 1 to 4 days for full effect, although some people get complete relief of symptoms within 24 hours

14-Day Course of Treatment
■ take 1 tablet before eating in the morning

do not crush or chew tablets
■ place the tablet on tongue; tablet disintegrates, with or without water. The tablets can also be swallowed whole with water.

■ take every day for 14 days

■ do not take more than 1 tablet a day

■ do not use for more than 14 days unless directed by your doctor

■ do not take this medicine with alcohol

Repeated 14-Day Course (if needed)
■ you may repeat a 14-day course every 4 months

do not take for more than 14 days or more often than every 4 months unless directed by a doctor

■ children under 18 years of age: ask a doctor before use. Heartburn in children may sometimes be caused by a serious condition.

Other information
■ read the directions, warnings and package insert before use ■ keep the carton and package insert. They contain important information. ■ store at 20-25°C (68-77°F) ■ keep product out of high heat and humidity ■ protect product from moisture

Inactive ingredients ascorbic acid, cetyl alcohol, colloidal silicon dioxide, copovidone, croscopoldone, hawt, hypromellose, hypromellose phthalate, maize methylcellulose, mannitol, magnesium, microcrystalline cellulose, polyorbate 80, propylene glycol, silicon dioxide, sodium stearyl fumarate, sorbitol, sucralose, sugar spheres, talc, titanium dioxide, triethyl citrate

8U174 FA C7-V 081920

Location for lot number and expiration date



KEEP THE CARTON AND PACKAGE INSERT. THEY CONTAIN IMPORTANT INFORMATION.

Safety Feature – Do not use if printed tablet blister unit is open or torn.

NDC 64239-181-01

Treats Frequent Heartburn



Compare to the active ingredient in Prevacid® 24 HR*

24 HR
Lansoprazole
Delayed Release
Orally Disintegrating Tablets 15 mg
Acid Reducer



May take 1 to 4 days for full effect

Dissolve Tabs

Orally Disintegrating Tablets

14 TABLETS

ONE 14-DAY COURSE OF TREATMENT

Melts in your mouth
Dissolves without water

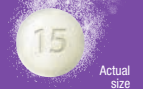

STANDARD FORMAT

TYPE SIZES:
TITLE: 9 pt Helvetica Neue LT Std 77 Bold Condensed Oblique
TITLE (continued): 8 pt Helvetica Neue LT Std 77 Bold Condensed Oblique
(continued) 8 pt Helvetica Neue LT Std 57 Condensed
HEADINGS: 8 pt Helvetica Neue LT Std 77 Bold Condensed Oblique
SUBHEADINGS: 6 pt Helvetica Neue LT Std 77 Bold Condensed
TEXT: 6 pt Helvetica Neue LT Std 57 Condensed
LEADING: 6.5 pt
BULLETS: 5 pt Square with 2 M'S spacing between statements
TELEPHONE #: 6 pt Helvetica Neue LT Std 77 Bold Condensed
HEAVY LINES: 1.5 pt
HAIRLINES: 0.5 pt
Hairlines extend to within two spaces of the "Drug Facts" box

<p>Drug Facts (continued)</p> <p>Directions ■ adults 18 years of age and older ■ this product is to be used once a day (every 24 hours), every day for 14 days ■ it may take 1 to 4 days for full effect, although some people get complete relief of symptoms within 24 hours</p> <p>14-Day Course of Treatment ■ take 1 tablet before eating in the morning ■ do not crush or chew tablets ■ place the tablet on tongue; tablet disintegrates, with or without water. The tablets can also be swallowed whole with water.</p> <p>Do not use ■ if you have trouble pain swallowing food, vomiting with blood, or bloody or black stools. These may be signs of a serious condition. See your doctor. ■ Ask a doctor before use if you have</p> <p>Warnings ■ liver diseases ■ headburn over 3 months. This may be a sign of a more serious condition. ■ heartburn with lightheadedness, sweating or dizziness ■ chest pain or shoulder pain with shortness of breath; sweating; pain spreading to arms, neck or shoulders; or lightheadedness</p> <p>Use ■ treats frequent heartburn (occurs 2 or more days a week) ■ not intended for immediate relief of heartburn; this drug may take 1 to 4 days for full effect</p> <p>Ask a doctor before use if you have ■ frequent wheezing, particularly with heartburn ■ unexplained weight loss ■ nausea or vomiting ■ stomach pain</p> <p>Ask a doctor or pharmacist before use if you are taking a prescription drug. Acid reducers may interact with certain prescription drugs.</p> <p>Stop use and ask a doctor if ■ your heartburn continues or worsens ■ you need to take this product for more than 14 days ■ you need to take more than 1 course of treatment every 4 months ■ you get diarrhea ■ you develop a rash or joint pain</p> <p>If pregnant or breast-feeding, ask a health care professional before use. ■ Keep out of reach of children. In case of overdose, get medical help or contact a Poison Control Center right away (1-800-222-1222).</p>	<p>Drug Facts</p> <p>Active ingredient (in each tablet) Lansoprazole 15 mg.....Acid Reducer</p> <p>Purpose</p> <p>14-Day Course of Treatment ■ take 1 tablet before eating in the morning ■ do not crush or chew tablets ■ place the tablet on tongue; tablet disintegrates, with or without water. The tablets can also be swallowed whole with water.</p> <p>Do not use ■ if you have trouble pain swallowing food, vomiting with blood, or bloody or black stools. These may be signs of a serious condition. See your doctor. ■ Ask a doctor before use if you have</p> <p>Warnings ■ liver diseases ■ headburn over 3 months. This may be a sign of a more serious condition. ■ heartburn with lightheadedness, sweating or dizziness ■ chest pain or shoulder pain with shortness of breath; sweating; pain spreading to arms, neck or shoulders; or lightheadedness</p> <p>Use ■ treats frequent heartburn (occurs 2 or more days a week) ■ not intended for immediate relief of heartburn; this drug may take 1 to 4 days for full effect</p> <p>Ask a doctor before use if you have ■ frequent wheezing, particularly with heartburn ■ unexplained weight loss ■ nausea or vomiting ■ stomach pain</p> <p>Ask a doctor or pharmacist before use if you are taking a prescription drug. Acid reducers may interact with certain prescription drugs.</p> <p>Stop use and ask a doctor if ■ your heartburn continues or worsens ■ you need to take this product for more than 14 days ■ you need to take more than 1 course of treatment every 4 months ■ you get diarrhea ■ you develop a rash or joint pain</p> <p>If pregnant or breast-feeding, ask a health care professional before use. ■ Keep out of reach of children. In case of overdose, get medical help or contact a Poison Control Center right away (1-800-222-1222).</p>
<p>5:00 PM EST Questions or comments? 1-800-719-9260; weekdays 7:30 AM to 7:30 PM EST</p>	<p>8U174 FA C7-J 081320</p>

Location for lot number and expiration date



KEEP THE CARTON AND PACKAGE INSERT.
THEY CONTAIN IMPORTANT INFORMATION.

Safety Feature –
Do not use if printed tablet blister unit is open or torn.

NDC 64239-181-01

Treats Frequent Heartburn

24 HR

Lansoprazole

Delayed Release
Orally Disintegrating Tablets 15 mg
Acid Reducer

May take 1 to 4 days for full effect

Dissolve Tabs

14 TABLETS ONE 14-DAY COURSE OF TREATMENT

MELTech™
Melts In Your Mouth

Compare to the active ingredient in Prevacid® 24 HR*

Child-resistant



Strawberry Flavor



Actual size

STANDARD FORMAT

TYPE SIZES:
TITLE: 9 pt Helvetica Neue LT Std 77 Bold Condensed Oblique
TITLE (continued): 8 pt Helvetica Neue LT Std 77 Bold Condensed Oblique
(continued) 8 pt Helvetica Neue LT Std 57 Condensed
HEADINGS: 8 pt Helvetica Neue LT Std 77 Bold Condensed Oblique
SUBHEADINGS: 6 pt Helvetica Neue LT Std 77 Bold Condensed
TEXT: 6 pt Helvetica Neue LT Std 57 Condensed
LEADING: 6.5 pt
BULLETS: 5 pt Square with 2 M'S spacing between statements
TELEPHONE #: 6 pt Helvetica Neue LT Std 77 Bold Condensed
HEAVY LINES: 1.5 pt
HAIRLINES: 0.5 pt
Hairstyles extend to within two spaces of the "Drug Facts" box

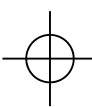

This product is not manufactured or distributed by Takeda Pharmaceuticals U.S.A., Inc., owner of the registered trademark Prevacid®.

10 Hakidma Street, Yokneam 2069200, Israel
Deceqel Pharma Technologies Ltd
Manufactured by:
Made in Israel

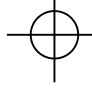

Lansoprazole

Delayed Release
Orally Disintegrating Tablets 15 mg

5:00 PM EST
Questions or comments? 1-800-719-9260; weekdays 7:30 AM to

Drug Facts (continued)

Active ingredient (in each tablet) Lansoprazole 15 mg, Acid Reducer

Purpose Acid Reducer

Directions adults 18 years of age and older this product is to be used once a day (every 24 hours), every day for 14 days it may take 1 to 4 days for full effect, although some people get complete relief of symptoms within 24 hours

14-Day Course of Treatment take 1 tablet before eating in the morning do not crush or chew tablets place the tablet on tongue; tablet disintegrates, with or without water. The tablets can also be swallowed whole with water. take every day for 14 days do not take more than 1 tablet a day do not use for more than 14 days unless directed by your doctor

Repeat 14-Day Course (if needed) you may repeat a 14-day course every 4 months do not take for more than 14 days or more often than every 4 months unless directed by a doctor children under 18 years of age: ask a doctor before use. Heartburn in children may sometimes be caused by a serious condition. read the directions, warnings and package insert before use keep the carton and package insert. They contain important information. protect product from moisture store at 20-25°C (68-77°F). Keep product out of high heat and humidity

Other information keep the carton and package insert. They contain important information. protect product from moisture store at 20-25°C (68-77°F). Keep product out of high heat and humidity

Inactive ingredients ascorbic acid, cetyl alcohol, colloidal silicon dioxide, copovidone, crospovidone, flavor, hypromellose, hypromellose phthalate, maize starch, polyethylene glycol, silicon dioxide, sodium stearyl fumarate, sorbitol, sucralose, sugar spheres, talc, titanium dioxide, triethyl citrate

Warnings Allergy alert: do not use if you are allergic to lansoprazole Do not use if you have trouble or pain swallowing food, vomiting with blood, or bloody or black stools. These may be signs of a serious condition. See your doctor. Ask a doctor before use if you have liver disease chest pain or shoulder pain with shortness of breath, sweating, pain spreading to arms, neck or shoulders; or lightheadedness frequent wheezing, particularly with heartburn unexplained weight loss nausea or vomiting Ask a doctor or pharmacist before use if you are taking a prescription drug. Ask your doctor if you are taking a prescription drug. Stop use and ask a doctor if you need to take this product for more than 14 days you need to take more than 1 course of treatment every 4 months you develop a rash or joint pain If pregnant or breast-feeding, ask a health care professional before use. Keep out of reach of children. In case of overdose, get medical help or contact a Poison Control Center right away (1-800-222-1222).

8U130 FA C7 081320

Location for lot number and expiration date



Lansoprazole

Delayed Release
Orally Disintegrating Tablets 15 mg

Safety Feature – Do not use if printed tablet blister unit is open or torn.

KEEP THE CARTON AND PACKAGE INSERT.
THEY CONTAIN IMPORTANT INFORMATION.



NDC 64239-181-02

Treats Frequent Heartburn



Lansoprazole

Delayed Release
Orally Disintegrating Tablets 15 mg
Acid Reducer

May take 1 to 4 days for full effect

Dissolve Tabs

28 TABLETS

TWO 14-DAY COURSES
OF TREATMENT

Melts in your mouth



Actual size



Melts In Your Mouth

Compare to the active ingredient
in Prevacid® 24 HR*



Strawberry
Flavor

STANDARD FORMAT

TYPE SIZES:
TITLE: 9 pt Helvetica Neue LT Std 77 Bold Condensed Oblique
TITLE (continued): 8 pt Helvetica Neue LT Std 77 Bold Condensed Oblique
(continued) 8 pt Helvetica Neue LT Std 57 Condensed
HEADINGS: 8 pt Helvetica Neue LT Std 77 Bold Condensed Oblique
SUBHEADINGS: 6 pt Helvetica Neue LT Std 77 Bold Condensed
TEXT: 6 pt Helvetica Neue LT Std 57 Condensed
LEADING: 6.5 pt
BULLETS: 5 pt Square with 2 M'S spacing between statements
TELEPHONE #: 6 pt Helvetica Neue LT Std 77 Bold Condensed
HEAVY LINES: 1.5 pt
HAIRLINES: 0.5 pt
Hairlines extend to within two spaces of the "Drug Facts" box

Drug Facts
Active Ingredient (in each tablet)
Lansoprazole 15 mg; Acid Reducer

Purpose
Acid Reducer

Use
■ treats frequent heartburn (occurs 2 or more days a week)
■ not intended for immediate relief of heartburn; this drug may take 1 to 4 days for full effect

Warnings
■ **Do not use** if you have trouble or pain swallowing food, vomiting with blood, or bloody or black stools. These may be signs of a serious condition. See your doctor.
■ **Ask a doctor before use if you have** liver disease, had heartburn over 3 months. This may be a sign of a more serious condition, heartburn with **lightheadedness, sweating or dizziness**, chest pain or shoulder pain with shortness of breath; sweating; pain spreading to arms, neck or shoulders; or lightheadedness

Ask a doctor or pharmacist before use if you are taking a prescription drug. Acid reducers may interact with certain prescription drugs.
■ stomach pain
■ nausea or vomiting
■ unexplained weight loss
■ frequent wheezing, particularly with heartburn

Stop use and ask a doctor if
■ your heartburn continues or worsens
■ you need to take this product for more than 14 days
■ you need to take more than 1 course of treatment every 4 months
■ you get diarrhea
■ you develop a rash or joint pain

If pregnant or breast-feeding, ask a health care professional before use. Keep out of reach of children. In case of overdose, get medical help or contact a Poison Control Center right away (1-800-222-1222).

5:00 PM EST

Questions or comments? 1-800-719-9260; weekdays 7:30 AM to

Drug Facts (continued)

Directions
■ adults 18 years of age and older
■ this product is to be used once a day (every 24 hours), every day for 14 days
■ it may take 1 to 4 days for full effect, although some people get complete relief of symptoms within 24 hours

1-4-Day Course of Treatment
■ take 1 tablet before eating in the morning
■ do not crush or chew tablets
■ place the tablet on tongue; tablet disintegrates, with or without water. The tablets can also be swallowed whole with water.
■ take every day for 14 days
■ do not take more than 1 tablet a day
■ do not use for more than 14 days unless directed by your doctor

Repeated 1-4-Day Course (if needed)
■ you may repeat a 1-4 day course every 4 months
■ do not take for more than 14 days or more often than every 4 months unless directed by a doctor

■ children under 18 years of age: ask a doctor before use. Heartburn in children may sometimes be caused by a serious condition.

Other information
■ read the directions, warnings and package insert before use
■ keep the carton and package insert. They contain important information.
■ store at 20-25°C (68-77°F) ■ keep product out of high heat and humidity
■ protect product from moisture

Inactive ingredients ascorbic acid, cetyl alcohol, colloidal silicon dioxide, copovidone, croscopolone, flavor, hypromellose, hydroxyethylcellulose, mazel, milled dextrin, maltitol, mannitol, magnesium, microcrystalline cellulose, polyethylene glycol, polyethylene glycol, silicon dioxide, sodium stearyl fumarate, sorbitol, sucralose, sugar spheres, talc, titanium dioxide, triethyl citrate

8U130 FA C7-V 081320

Location for lot number and expiration date

NDC 64239-181-02

Treats Frequent Heartburn

24 HR

Lansoprazole
Delayed Release
Orally Disintegrating Tablets 15 mg
Acid Reducer

May take 1 to 4 days for full effect

Dissolve Tabs

28 TABLETS TWO 14-DAY COURSES OF TREATMENT

MELTech™
Melts In Your Mouth

Compare to the active ingredient in Prevacid® 24 HR*

Strawberry Flavor

Orally Disintegrating Tablets

Melts in your mouth
Dissolves without water

Actual size

STANDARD FORMAT

TYPE SIZES:
TITLE: 9 pt Helvetica Neue LT Std 77 Bold Condensed Oblique
TITLE (continued): 8 pt Helvetica Neue LT Std 77 Bold Condensed Oblique
(continued) 8 pt Helvetica Neue LT Std 57 Condensed
HEADINGS: 8 pt Helvetica Neue LT Std 77 Bold Condensed Oblique
SUBHEADINGS: 6 pt Helvetica Neue LT Std 77 Bold Condensed
TEXT: 6 pt Helvetica Neue LT Std 57 Condensed
LEADING: 6.5 pt
BULLETS: 5 pt Square with 2 M'S spacing between statements
TELEPHONE #: 6 pt Helvetica Neue LT Std 77 Bold Condensed
HEAVY LINES: 1.5 pt
HAIRLINES: 0.5 pt
Hairlines extend to within two spaces of the "Drug Facts" box



Manufactured by:
Dexcel Pharma Technologies Ltd
10 Hakdima Street, Yokneam 2069200, Israel
Made in Israel

*This product is not manufactured or distributed by Takeda Pharmaceuticals U.S.A., Inc., owner of the registered trademark Prevacid®.



<p>Drug Facts Lansoprazole 15 mg (in each tablet) Purpose Acid Reducer</p> <p>Use ■ treats frequent heartburn (occurs 2 or more days a week) ■ not intended for immediate relief of heartburn; this drug may take 1 to 4 days for full effect</p> <p>Warnings Do not use ■ if you have trouble or pain swallowing food, vomiting with blood, or bloody or black stools. These may be signs of a serious condition. See your doctor. Ask a doctor before use if you have ■ liver disease ■ head heartburn over 3 months. This may be a sign of a more serious condition. ■ heartburn with lightheadness, sweating or dizziness ■ chest pain or shoulder pain with shortness of breath, sweating, pain spreading to arms, neck or shoulders; or lightheadness</p> <p>Ask a doctor or pharmacist before use if you are taking a prescription drug. Acid reducers may interact with certain prescription drugs. ■ nausea or vomiting ■ stomach pain</p> <p>Stop use and ask a doctor if ■ your heartburn continues or worsens ■ you need to take this product for more than 14 days ■ you need to take more than 1 course of treatment every 4 months ■ you get diarrhea ■ you develop a rash or joint pain</p> <p>If pregnant or breast-feeding, ask a health care professional before use. Keep out of reach of children. In case of overdose, get medical help or contact a Poison Control Center right away (1-800-222-1222).</p>	<p>Drug Facts (continued)</p> <p>Directions ■ adults 18 years of age and older ■ this product is to be used once a day (every 24 hours), every day for 14 days ■ it may take 1 to 4 days for full effect, although some people get complete relief of symptoms within 24 hours</p> <p>14-Day Course of Treatment ■ take 1 tablet before eating in the morning ■ do not crush or chew tablets ■ place the tablet on tongue; tablet disintegrates, with or without water. The tablets can also be swallowed whole with water. ■ take every day for 14 days ■ do not take more than 1 tablet a day ■ do not use for more than 14 days unless directed by your doctor. ■ do not take this medicine with alcohol</p> <p>Repeated 14-Day Course (if needed) ■ you may repeat a 14-day course every 4 months unless directed by a doctor</p> <p>■ children under 18 years of age: ask a doctor before use. Heartburn in children may sometimes be caused by a serious condition.</p> <p>Other information ■ read the directions, warnings and package insert before use ■ keep the carton and package insert. They contain important information. ■ store at 20-25°C (68-77°F) ■ keep product out of high heat and humidity ■ protect product from moisture</p> <p>Inactive ingredients ascorbic acid, cetyl alcohol, colloidal silicon dioxide, copovidone, croscopolone, flavor, hypromellose, hypromellose phthalate, maize maca, polyethylene glycol, silicon dioxide, sodium stearoyl fumarate, sorbitol, sucralose, sugar spheres, talc, titanium dioxide, triethyl citrate</p> <p>Questions or comments? 1-800-719-9260, weekdays 7:30 AM to 5:00 PM EST</p>
--	---

8U130 FA C7-A 081320

Location for lot number and expiration date



Lansoprazole

Delayed Release
Orally Disintegrating Tablets 15 mg

Safety Feature – Do not use if printed tablet blister unit is open or torn.

KEEP THE CARTON AND PACKAGE INSERT. THEY CONTAIN IMPORTANT INFORMATION.





NDC 64239-181-02

Treats Frequent Heartburn



Melts In Your Mouth

Compare to the active ingredient in Prevacid® 24 HR*

Value 2 Pack



Strawberry Flavor



Lansoprazole

Delayed Release
Orally Disintegrating Tablets 15 mg
Acid Reducer

May take 1 to 4 days for full effect

Dissolve Tabs

28 TABLETS

TWO 14-DAY COURSES OF TREATMENT

Melts in your mouth

Dissolves without water



Actual size

STANDARD FORMAT

TYPE SIZES:
TITLE: 9 pt Helvetica Neue LT Std 77 Bold Condensed Oblique
TITLE (continued): 8 pt Helvetica Neue LT Std 77 Bold Condensed Oblique
(continued) 8 pt Helvetica Neue LT Std 57 Condensed
HEADINGS: 8 pt Helvetica Neue LT Std 77 Bold Condensed Oblique
SUBHEADINGS: 6 pt Helvetica Neue LT Std 77 Bold Condensed
TEXT: 6 pt Helvetica Neue LT Std 57 Condensed
LEADING: 6.5 pt
BULLETS: 5 pt Square with 2 M'S spacing between statements
TELEPHONE #: 6 pt Helvetica Neue LT Std 77 Bold Condensed
HEAVY LINES: 1.5 pt
HAIRLINES: 0.5 pt
 Hairlines extend to within two spaces of the "Drug Facts" box



owner of the registered trademark Prevacid®.
This product is not manufactured or distributed by Takeda Pharmaceuticals U.S.A., Inc.,
10 Hakdama Street, Yokneam 2069200, Israel
Cexcel Pharma Technologies Ltd
Manufactured by:
Made in Israel



5:00 PM EST
Questions or comments? 1-800-719-9260; weekdays 7:30 AM to

Keep out of reach of children. In case of overdose, get medical help or contact a Poison Control Center right away (1-800-222-1222).

If pregnant or breast-feeding, ask a health care professional before use.

- you develop a rash or joint pain
- you get diarrhea
- you need to take more than 1 course of treatment every 4 months
- you need to take this product for more than 14 days
- your heartburn continues or worsens

Stop use and ask a doctor if

Acid reducers may interact with certain prescription drugs.

Ask a doctor or pharmacist before use if you are taking a prescription drug.

- nausea or vomiting
- stomach pain
- unexplained weight loss
- frequent wheezing, particularly with heartburn

requent chest pain

- chest pain or shoulder pain with shortness of breath, sweating, pain spreading to arms, neck or shoulders; or lightheadedness
- heartburn with lightheadedness, sweating or dizziness
- heartburn over 3 months. This may be a sign of a more serious condition.
- liver disease

Ask a doctor before use if you have

- black stools. These may be signs of a serious condition. See your doctor.
- if you have trouble or pain swallowing food, vomiting with blood, or bloody or Do not use

Warnings

Allergy alert: do not use if you are allergic to lansoprazole

for full effect

■ treats frequent heartburn (occurs 2 or more days a week)

■ not intended for immediate relief of heartburn; this drug may take 1 to 4 days

8U130 FA C7-J 081320

Drug Facts

Active ingredient (in each tablet)

Lansoprazole 15 mg;.....Acid Reducer

Purpose

Acid Reducer

Directions

adults 18 years of age and older

■ this product is to be used once a day (every 24 hours), every day for 14 days

■ it may take 1 to 4 days for full effect, although some people get complete relief of symptoms within 24 hours

14-Day Course of Treatment

take 1 tablet before eating in the morning

■ do not crush or chew tablets

place the tablet on tongue; tablet disintegrates, with or without water. The tablets can also be swallowed whole with water.

take every day for 14 days

do not take more than 1 tablet a day

do not use for more than 14 days unless directed by your doctor

do not take this medicine with alcohol

Repeated 14-Day Course (if needed)

do not take for more than 14 days or more often than every 4 months

do not take for more than 14 days or more often than every 4 months unless directed by a doctor

children under 18 years of age: ask a doctor before use. Heartburn in children may sometimes be caused by a serious condition.

Other Information

read the directions, warnings and package insert before use

keep the carton and package insert. They contain important information.

store at 20-25°C (68-77°F) ■ keep product out of high heat and humidity

protect product from moisture

Inactive ingredients ascorbic acid, cetyl alcohol, colloidal silicon dioxide, copovidone, croscopolone, flavor, hypromellose, hypromellose phthalate, maize starch, mannitol, microcrystalline cellulose, microcrystalline cellulose, polyorbate 80, polyethylene glycol, silicon dioxide, sodium stearyl fumarate, sorbitol, sucralose, sugar spheres, talc, titanium dioxide, triethyl citrate

Drug Facts (continued)

Lansoprazole
Delayed Release
Orally Disintegrating Tablets 15 mg

Lansoprazole
Delayed Release
Orally Disintegrating Tablets 15 mg

Safety Feature – Do not use if printed tablet blister unit is open or torn.

KEEP THE CARTON AND PACKAGE INSERT.
THEY CONTAIN IMPORTANT INFORMATION.





NDC 64239-181-02

Treats Frequent Heartburn

MELTech™
Melts In Your Mouth

Compare to the active ingredient in Prevacid® 24 HR*

Child-resistant

24 HR

Lansoprazole
Delayed Release
Orally Disintegrating Tablets 15 mg
Acid Reducer

May take 1 to 4 days for full effect

Dissolve Tabs

28 TABLETS TWO 14-DAY COURSES OF TREATMENT

Melts in your mouth
Dissolves without water

 Strawberry Flavor

 15 Actual size



Location for lot number and expiration date

STANDARD FORMAT

TYPE SIZES:

TITLE: 9 pt Helvetica Neue LT Std 77 Bold Condensed Oblique

TITLE (continued): 8 pt Helvetica Neue LT Std 77 Bold Condensed Oblique (continued)

8 pt Helvetica Neue LT Std 57 Condensed

HEADINGS: 8 pt Helvetica Neue LT Std 77 Bold Condensed Oblique

SUBHEADINGS: 6 pt Helvetica Neue LT Std 77 Bold Condensed

TEXT: 6 pt Helvetica Neue LT Std 57 Condensed

LEADING: 6.5 pt

BULLETS: 5 pt Square with 2 M'S spacing between statements

TELEPHONE #: 6 pt Helvetica Neue LT Std 77 Bold Condensed

HEAVY LINES: 1.5 pt

HAIRLINES: 0.5 pt

Hairlines extend to within two spaces of the "Drug Facts" box

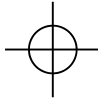

Manufactured by:
Dexcel Pharma Technologies Ltd
10 Hakidma Street, Yokneam 2069200, Israel

*This product is not manufactured or distributed by Takeda Pharmaceuticals U.S.A., Inc., owner of the registered trademark Prevacid®.



8U130 FA C7-L 081320

Drug Facts	<p>Active ingredient (in each tablet) Lansoprazole 15 mg.....Acid Reducer</p> <p>Purpose Acid Reducer</p>
Use	<ul style="list-style-type: none"> ■ treats frequent heartburn (occurs 2 or more days a week) ■ not intended for immediate relief of heartburn; this drug may take 1 to 4 days for full effect
Warnings	<p>Do not use</p> <ul style="list-style-type: none"> ■ if you have trouble or pain swallowing food, vomiting with blood, or bloody or black stools. These may be signs of a serious condition. See your doctor. <p>Ask a doctor before use if you have</p> <ul style="list-style-type: none"> ■ liver diseases ■ had heartburn over 3 months. This may be a sign of a more serious condition. <p>heartburn with lightheadedness, sweating or dizziness</p> <ul style="list-style-type: none"> ■ chest pain or shoulder pain with shortness of breath, sweating, pain spreading to arms, neck or shoulders, or lightheadedness <p>frequent chest pain</p> <ul style="list-style-type: none"> ■ frequent wheezing, particularly with heartburn ■ unexplained weight loss ■ nausea or vomiting <p>Ask a doctor or pharmacist before use if you are taking a prescription drug.</p> <p>Acid reducers may interact with certain prescription drugs.</p>
Stop use and ask a doctor if	<ul style="list-style-type: none"> ■ your heartburn continues or worsens ■ you need to take this product for more than 14 days ■ you need to take more than 1 course of treatment every 4 months ■ you develop a rash or joint pain ■ you get diarrhea
If pregnant or breast-feeding, ask a health care professional before use.	<p>Keep out of reach of children. In case of overdose, get medical help or contact a Poison Control Center right away (1-800-222-1222).</p>
Questions or comments? 1-800-719-9260; weekdays 7:30 AM to 5:00 PM EST	

Lansoprazole
Delayed Release
Orally Disintegrating Tablets 15 mg

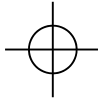



Lansoprazole

Delayed Release
Orally Disintegrating Tablets 15 mg

Safety Feature – Do not use if printed tablet blister unit is open or torn.

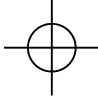
KEEP THE CARTON AND PACKAGE INSERT.
THEY CONTAIN IMPORTANT INFORMATION.







NDC 64239-181-02

Treats Frequent Heartburn

24 HR

Lansoprazole

Delayed Release
Orally Disintegrating Tablets 15 mg
Acid Reducer

May take 1 to 4 days for full effect

Dissolve Tabs

28 TABLETS

TWO 14-DAY COURSES
OF TREATMENT

Compare to the active ingredient
in Prevacid® 24 HR*

100% More Free!
14 Free Tablets!



Strawberry
Flavor



Actual
size

Melts in your mouth
Dissolves without water





STANDARD FORMAT

TYPE SIZES:

TITLE: 9 pt Helvetica Neue LT Std 77 Bold Condensed Oblique

TITLE (continued): 8 pt Helvetica Neue LT Std 77 Bold Condensed Oblique

TITLE (continued): 8 pt Helvetica Neue LT Std 57 Condensed

HEADINGS: 8 pt Helvetica Neue LT Std 77 Bold Condensed Oblique

SUBHEADINGS: 6 pt Helvetica Neue LT Std 77 Bold Condensed

TEXT: 6 pt Helvetica Neue LT Std 57 Condensed

LEADING: 6.5 pt

BULLETS: 5 pt Square with 2 M'S spacing between statements

TELEPHONE #: 6 pt Helvetica Neue LT Std 77 Bold Condensed

HEAVY LINES: 1.5 pt

HAIRLINES: 0.5 pt

Hairlines extend to within two spaces of the "Drug Facts" box

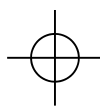

*This product is not manufactured or distributed by Takeda Pharmaceuticals U.S.A., Inc.
10 Hakdama Street, Yokneam 2069200, Israel
Dexcel Pharma Technologies Ltd
Manufactured by:
Made in Israel

Drug Facts	<p>Active ingredient (in each tablet) Lansoprazole 15 mg</p> <p>Purpose Acid Reducer</p>
Use	<p>■ treats frequent heartburn (occurs 2 or more days a week)</p> <p>■ not intended for immediate relief of heartburn; this drug may take 1 to 4 days for full effect</p>
Warnings	<p>Allergy alert: do not use if you are allergic to lansoprazole</p> <p>Do not use</p> <p>■ if you have trouble or pain swallowing food, vomiting with blood, or bloody or black stools. These may be signs of a serious condition. See your doctor.</p> <p>Ask a doctor before use if you have</p> <ul style="list-style-type: none"> ■ liver disease ■ had heartburn over 3 months. This may be a sign of a more serious condition. ■ heartburn with lightheadedness, sweating or dizziness ■ chest pain or shoulder pain with shortness of breath; sweating; pain spreading to arms, neck or shoulders; or lightheadedness ■ frequent wheezing, particularly with heartburn ■ unexplained weight loss ■ nausea or vomiting ■ stomach pain <p>Ask a doctor or pharmacist before use if you are taking a prescription drug. Acid reducers may interact with certain prescription drugs.</p>
Stop use and ask a doctor if	<ul style="list-style-type: none"> ■ your heartburn continues or worsens ■ you need to take this product for more than 14 days ■ you need to take more than 1 course of treatment every 4 months ■ you get diarrhea ■ you develop a rash or joint pain <p>If pregnant or breast-feeding, ask a health care professional before use. Keep out of reach of children. In case of overdose, get medical help or contact a Poison Control Center right away (1-800-222-1222).</p>
Questions or comments?	<p>1-800-719-9260; weekdays 7:30 AM to 5:00 PM EST</p>

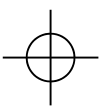

8U130 FA C7-N 081320



Lansoprazole

Delayed Release
Orally Disintegrating Tablets 15 mg

Safety Feature – Do not use if printed tablet blister unit is open or torn.

KEEP THE CARTON AND PACKAGE INSERT. THEY CONTAIN IMPORTANT INFORMATION.





NDC 64239-181-02

Treats Frequent Heartburn

24 HR

Lansoprazole

Delayed Release
Orally Disintegrating Tablets 15 mg
Acid Reducer

May take 1 to 4 days for full effect

Dissolve Tabs

28 TABLETS

TWO 14-DAY COURSES OF TREATMENT

MELTech™
Melts In Your Mouth

Compare to the active ingredient in Prevacid® 24 HR*

Bonus Size!
14 Tablets Free

Strawberry Flavor

Actual size

Melts in your mouth

Dissolves without water



STANDARD FORMAT

TYPE SIZES:
TITLE: 9 pt Helvetica Neue LT Std 77 Bold Condensed Oblique
 TITLE (continued): 8 pt Helvetica Neue LT Std 77 Bold Condensed Oblique
 (continued) 8 pt Helvetica Neue LT Std 57 Condensed
HEADINGS: 8 pt Helvetica Neue LT Std 77 Bold Condensed Oblique
SUBHEADINGS: 6 pt Helvetica Neue LT Std 77 Bold Condensed
TEXT: 6 pt Helvetica Neue LT Std 57 Condensed
LEADING: 6.5 pt
BULLETS: 5 pt Square with 2 M'S spacing between statements
TELEPHONE #: 6 pt Helvetica Neue LT Std 77 Bold Condensed
HEAVY LINES: 1.5 pt
HAIRLINES: 0.5 pt
 Hairlines extend to within two spaces of the "Drug Facts" box

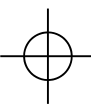

*This product is not manufactured or distributed by Takeda Pharmaceuticals U.S.A., Inc.
Dexcel Pharma Technologies Ltd
10 Hakdama Street, Yokneam 2069200, Israel
Manufactured by:
Made in Israel

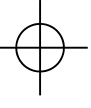

Drug Facts

Active ingredient (in each tablet) Lansoprazole 15 mg.

Purpose Acid Reducer

Use
 ■ treats frequent heartburn (occurs 2 or more days a week)
 ■ not intended for immediate relief of heartburn; this drug may take 1 to 4 days for full effect

Warnings
 ■ if you have trouble or pain swallowing food, vomiting with blood, or bloody or black stools. These may be signs of a serious condition. See your doctor.
 ■ Do not use if you are allergic to lansoprazole

Ask a doctor before use if you have
 ■ liver disease
 ■ had heartburn over 3 months. This may be a sign of a more serious condition.
 ■ heartburn with **lightheadedness, sweating or dizziness**
 ■ chest pain or shoulder pain with shortness of breath, sweating, pain spreading to arms, neck or shoulders, or lightheadedness

Ask a doctor or pharmacist before use if you are taking a prescription drug.
 Acid reducers may interact with certain prescription drugs.

Stop use and ask a doctor if
 ■ your heartburn continues or worsens
 ■ you need to take this product for more than 14 days
 ■ you need to take more than 1 course of treatment every 4 months
 ■ you get diarrhea
 ■ you develop a rash or joint pain

If pregnant or breast-feeding, ask a health care professional before use.
Keep out of reach of children. In case of overdose, get medical help or contact a Poison Control Center right away (1-800-222-1222).

Other information
 ■ read the directions, warnings and package insert before use
 ■ keep the carton and package insert. They contain important information.
 ■ store at 20-25°C (68-77°F) ■ keep product out of high heat and humidity
 ■ protect product from moisture

Inactive ingredients ascorbic acid, cetyl alcohol, colloidal silicon dioxide, copovidone, croscarmellose, flavor, hypromellose, hypromellose phthalate, maize malto-dextrin, mannitol, magnesium, microcrystalline cellulose, polyborate 80, polyethylene glycol, silicon dioxide, sodium stearyl fumarate, sorbitol, sucralose, sugar spheres, talc, titanium dioxide, triethyl citrate

Questions or comments? 1-800-719-9260; weekdays 7:30 AM to 5:00 PM EST

8U130 FA C7-S 081320

Location for lot number and expiration date



Lansoprazole

Delayed Release
Orally Disintegrating Tablets 15 mg



0 000000 000000 0

Safety Feature – Do not use if printed tablet blister unit is open or torn.

KEEP THE CARTON AND PACKAGE INSERT.
THEY CONTAIN IMPORTANT INFORMATION.





NDC 64239-181-02

Treats Frequent Heartburn

MELTech™
Melts In Your Mouth

Compare to the active ingredient in Prevacid® 24 HR*

Bonus! 14 Tablets FREE

24 HR

Lansoprazole

Delayed Release
Orally Disintegrating Tablets 15 mg
Acid Reducer

May take 1 to 4 days for full effect

Dissolve Tabs

28 TABLETS TWO 14-DAY COURSES OF TREATMENT

Melts in your mouth
Dissolves without water



Strawberry Flavor



15 Actual Size



STANDARD FORMAT

TYPE SIZES:
TITLE: 9 pt Helvetica Neue LT Std 77 Bold Condensed Oblique
TITLE (continued): 8 pt Helvetica Neue LT Std 77 Bold Condensed Oblique
(continued) 8 pt Helvetica Neue LT Std 57 Condensed
HEADINGS: 8 pt Helvetica Neue LT Std 77 Bold Condensed Oblique
SUBHEADINGS: 6 pt Helvetica Neue LT Std 77 Bold Condensed
TEXT: 6 pt Helvetica Neue LT Std 57 Condensed
LEADING: 6.5 pt
BULLETS: 5 pt Square with 2 M'S spacing between statements
TELEPHONE #: 6 pt Helvetica Neue LT Std 77 Bold Condensed
HEAVY LINES: 1.5 pt
HAIRLINES: 0.5 pt
 Hairlines extend to within two spaces of the "Drug Facts" box



Lansoprazole

Delayed Release
Orally Disintegrating Tablets 15 mg

Location for lot number and expiration date

*This product is not manufactured or distributed by Takeda Pharmaceuticals U.S.A., Inc.,
10 Haklma Street, Yokneam 2069200, Israel
Manufactured by:
Dexcel Pharma Technologies Ltd
Made in Israel

Drug Facts

Active Ingredient (in each tablet)
Lansoprazole 15 mg.....Acid Reducer

Purpose

Directions
This product is to be used once a day (every 24 hours), every day for 14 days in adults 18 years of age and older.

14-Day Course of Treatment
Take 1 tablet before eating in the morning.

Warnings
Do not use if you are allergic to lansoprazole.

Do not use
If you have trouble or pain swallowing food, vomiting with blood, or bloody or black stools. These may be signs of a serious condition. See your doctor.

Ask a doctor before use if you have
Liver disease
Had heartburn over 3 months. This may be a sign of a more serious condition.
Heartburn with lightheadedness, sweating or dizziness
Chest pain or shoulder pain with shortness of breath, sweating, pain spreading to arms, neck or shoulders, or rightheadedness

Ask a doctor or pharmacist before use if you are taking a prescription drug.
Acid reducers may interact with certain prescription drugs.

Stop use and ask a doctor if
Your heartburn continues or worsens
You need to take this product for more than 14 days
You need to take more than 1 course of treatment every 4 months
You get diarrhea
You develop a rash or joint pain

If pregnant or breast-feeding, ask a health care professional before use.
Keep out of reach of children. In case of overdose, get medical help or contact a Poison Control Center right away (1-800-222-1222).

Questions or comments? 1-800-719-9260: weekdays 7:30 AM to 5:00 PM EST

Use
Treats frequent heartburn (occurs 2 or more days a week)
Not intended for immediate relief of heartburn; this drug may take 1 to 4 days for full effect

Warnings
Allergy alert: do not use if you are allergic to lansoprazole.

Do not use
If you have trouble or pain swallowing food, vomiting with blood, or bloody or black stools. These may be signs of a serious condition. See your doctor.

Ask a doctor before use if you have
Liver disease
Had heartburn over 3 months. This may be a sign of a more serious condition.
Heartburn with lightheadedness, sweating or dizziness
Chest pain or shoulder pain with shortness of breath, sweating, pain spreading to arms, neck or shoulders, or rightheadedness

Ask a doctor or pharmacist before use if you are taking a prescription drug.
Acid reducers may interact with certain prescription drugs.

Stop use and ask a doctor if
Your heartburn continues or worsens
You need to take this product for more than 14 days
You need to take more than 1 course of treatment every 4 months
You get diarrhea
You develop a rash or joint pain

If pregnant or breast-feeding, ask a health care professional before use.
Keep out of reach of children. In case of overdose, get medical help or contact a Poison Control Center right away (1-800-222-1222).

Questions or comments? 1-800-719-9260: weekdays 7:30 AM to 5:00 PM EST



Lansoprazole

Delayed Release
Orally Disintegrating Tablets 15 mg

Safety Feature – Do not use if printed tablet blister unit is open or torn.

KEEP THE CARTON AND PACKAGE INSERT.
THEY CONTAIN IMPORTANT INFORMATION.

8U155 FA C7 081320



NDC 64239-181-03

Treats Frequent Heartburn

MELTech™
Melts In Your Mouth

Compare to the active ingredient
in Prevacid® 24 HR*

24 HR

Lansoprazole

Delayed Release
Orally Disintegrating Tablets 15 mg
Acid Reducer

May take 1 to 4 days for full effect

Dissolve Tabs

42 TABLETS THREE 14-DAY COURSES OF TREATMENT

Melts in your mouth
Dissolves without water



Strawberry Flavor



15 Actual size



STANDARD FORMAT

TYPE SIZES:
TITLE: 9 pt Helvetica Neue LT Std 77 Bold Condensed Oblique
TITLE (continued): 8 pt Helvetica Neue LT Std 77 Bold Condensed Oblique
(continued) 8 pt Helvetica Neue LT Std 57 Condensed
HEADINGS: 8 pt Helvetica Neue LT Std 77 Bold Condensed Oblique
SUBHEADINGS: 6 pt Helvetica Neue LT Std 77 Bold Condensed
TEXT: 6 pt Helvetica Neue LT Std 57 Condensed
LEADING: 6.5 pt
BULLETS: 5 pt Square with 2 M'S spacing between statements
TELEPHONE #: 6 pt Helvetica Neue LT Std 77 Bold Condensed
HEAVY LINES: 1.5 pt
HAIRLINES: 0.5 pt
Hairlines extend to within two spaces of the "Drug Facts" box



Lansoprazole

Delayed Release
Orally Disintegrating Tablets 15 mg



Drug Facts

Active ingredient (in each tablet)
Lansoprazole 15 mg, Acid Reducer

Use
● treats frequent heartburn (occurs 2 or more days a week)
● not intended for immediate relief of heartburn; this drug may take 1 to 4 days for full effect

Warnings
● if you have trouble or pain swallowing food, vomiting with blood, or bloody or black stools. These may be signs of a serious condition. See your doctor.
● Ask a doctor before use if you have liver diseases, had heartburn over 3 months. This may be a sign of a more serious condition.
● chest pain or shoulder pain with shortness of breath, sweating, pain spreading to arms, neck or shoulders, or lightheadedness
● frequent chest pain
● frequent wheezing, particularly with heartburn
● unexplained weight loss
● nausea or vomiting
● stomach pain

Ask a doctor or pharmacist before use if you are taking a prescription drug.
Acid reducers may interact with certain prescription drugs.

Stop use and ask a doctor if
● your heartburn continues or worsens
● you need to take this product for more than 14 days
● you need to take more than 1 course of treatment every 4 months
● you get diarrhea
● you develop a rash or joint pain

If pregnant or breast-feeding, ask a health care professional before use.
Keep out of reach of children. In case of overdose, get medical help or contact a Poison Control Center right away (1-800-222-1222).

Questions or comments? 1-800-719-9260; weekdays 7:30 AM to 5:00 PM EST

Other information
● read the directions, warnings and package insert before use
● keep the carton and package insert. They contain important information.
● keep product out of high heat and humidity
● protect product from moisture

Inactive ingredients ascorbic acid, cetyl alcohol, colloidal silicon dioxide, copovidone, crospovidone, flavor, hypromellose, hypromellose phthalate, maize starch, polyethylene glycol, silicon dioxide, sodium stearyl fumarate, sorbitol, sucralose, sugar spheres, talc, titanium dioxide, triethyl citrate

Directions
● adults 18 years of age and older
● this product is to be used once a day (every 24 hours), every day for 14 days
● it may take 1 to 4 days for full effect, although some people get complete relief of symptoms within 24 hours

14-Day Course of Treatment
● take 1 tablet before eating in the morning
● do not crush or chew tablets
● place the tablet on tongue; tablet disintegrates, with or without water. The tablets can also be swallowed whole with water.
● take every day for 14 days
● do not take more than 1 tablet a day
● do not use for more than 14 days unless directed by your doctor
● do not take this medicine with alcohol

Repeated 14-Day Course (if needed)
● you may repeat a 14-day course every 4 months
● do not take for more than 14 days or more often than every 4 months
● unless directed by a doctor
● children under 18 years of age: ask a doctor before use. Heartburn in children may sometimes be caused by a serious condition.

Drug Facts (continued)

Lansoprazole
Delayed Release
Orally Disintegrating Tablets 15 mg

Safety Feature – Do not use if printed tablet blister unit is open or torn.

KEEP THE CARTON AND PACKAGE INSERT. THEY CONTAIN IMPORTANT INFORMATION.

NDC 64239-181-03

Treats Frequent Heartburn

MELTech™
Melts In Your Mouth

Compare to the active ingredient in Prevacid® 24 HR*

24 HR

Lansoprazole

Delayed Release
Orally Disintegrating Tablets 15 mg
Acid Reducer

May take 1 to 4 days for full effect

Dissolve Tabs

42 TABLETS THREE 14-DAY COURSES OF TREATMENT

Melts in your mouth
Dissolves without water

Orally Disintegrating Tablets

Strawberry Flavor

15 Actual size

Location for lot number and expiration date

8U155 FA C7-V 081320

STANDARD FORMAT

TYPE SIZES:
TITLE: 9 pt Helvetica Neue LT Std 77 Bold Condensed Oblique
TITLE (continued): 8 pt Helvetica Neue LT Std 77 Bold Condensed Oblique (continued) 8 pt Helvetica Neue LT Std 57 Condensed
HEADINGS: 8 pt Helvetica Neue LT Std 77 Bold Condensed Oblique
SUBHEADINGS: 6 pt Helvetica Neue LT Std 77 Bold Condensed
TEXT: 6 pt Helvetica Neue LT Std 57 Condensed
LEADING: 6.5 pt
BULLETS: 5 pt Square with 2 M'S spacing between statements
TELEPHONE #: 6 pt Helvetica Neue LT Std 77 Bold Condensed
HEAVY LINES: 1.5 pt
HAIRLINES: 0.5 pt
Hairlines extend to within two spaces of the "Drug Facts" box

Location for lot number and expiration date

Manufactured by:
Dexel Pharma Technologies Ltd
10 Hakdama Street, Yokneam 2069200, Israel

*This product is not manufactured or distributed by Takeda Pharmaceuticals U.S.A., Inc., owner of the registered trademark Prevacid®.

Lansoprazole
Delayed Release
Orally Disintegrating Tablets 15 mg

Drug Facts

Active ingredient (in each tablet)
Lansoprazole 15 mg.
Acid Reducer

Use
■ treats frequent heartburn (occurs 2 or more days a week)
■ not intended for immediate relief of heartburn; this drug may take 1 to 4 days for full effect

Warnings
■ **Do not use** if you have trouble or pain swallowing food, vomiting with blood, or bloody or black stools. These may be signs of a serious condition. See your doctor.
■ **Ask a doctor before use if you have**
■ had heartburn over 3 months. This may be a sign of a more serious condition.
■ heartburn with **lightheadedness, sweating or dizziness**
■ chest pain or shoulder pain with shortness of breath, sweating, pain spreading to arms, neck or shoulders, or lightheadedness
■ frequent **chest pain**
■ frequent wheezing, particularly with heartburn
■ explained weight loss
■ nausea or vomiting ■ stomach pain

Ask a doctor or pharmacist before use if you are taking a prescription drug.
Acid reducers may interact with certain prescription drugs.

Stop use and ask a doctor if
■ you heartburn continues or worsens
■ you need to take this product for more than 14 days
■ you need to take more than 1 course of treatment every 4 months
■ you get diarrhea
■ you develop a rash or joint pain

If pregnant or breast-feeding, ask a health care professional before use.
Keep out of reach of children. In case of overdose, get medical help or contact a Poison Control Center right away (1-800-222-1222).

Other information
■ read the directions, warnings and package insert before use
■ keep the carton and package insert. They contain important information.
■ store at 20-25°C (68-77°F) ■ keep product out of high heat and humidity
■ protect product from moisture

Inactive ingredients ascorbic acid, cetyl alcohol, colloidal silicon dioxide, copovidone, croscopolone, flavor, hypromellose, hypromellose phthalate, maize starch, polyethylene glycol, polyethylene glycol, sodium stearyl fumarate, sorbitol, sucralose, sugar spheres, talc, titanium dioxide, triethyl citrate, maldextrin, maltitol, mannitol, meglumine, microcrystalline cellulose, croscopolone, croscopolone, flavor, hypromellose, hypromellose phthalate, maize starch, polyethylene glycol, polyethylene glycol, sodium stearyl fumarate, sorbitol, sucralose, sugar spheres, talc, titanium dioxide, triethyl citrate

Questions or comments? 1-800-719-9260; weekdays 7:30 AM to 5:00 PM EST



Lansoprazole
Delayed Release
Orally Disintegrating Tablets 15 mg

Safety Feature – Do not use if printed tablet blister unit is open or torn.

KEEP THE CARTON AND PACKAGE INSERT. THEY CONTAIN IMPORTANT INFORMATION.

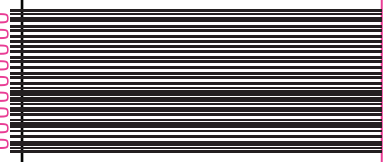

NDC 64239-181-03

Treats Frequent Heartburn

MELTech™
Melts In Your Mouth

Compare to the active ingredient in Prevacid® 24 HR*

Value 3 Pack

24 HR

Lansoprazole
Delayed Release
Orally Disintegrating Tablets 15 mg
Acid Reducer

May take 1 to 4 days for full effect

Dissolve Tabs

42 TABLETS THREE 14-DAY COURSES OF TREATMENT

Melts in your mouth
Dissolves without water



Strawberry Flavor

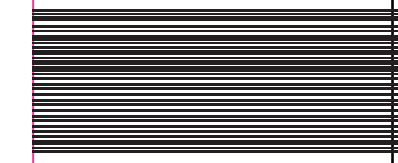
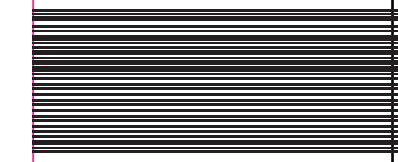

Actual size

STANDARD FORMAT

TYPE SIZES:
TITLE: 9 pt Helvetica Neue LT Std 77 Bold Condensed Oblique
TITLE (continued): 8 pt Helvetica Neue LT Std 77 Bold Condensed Oblique
(continued) 8 pt Helvetica Neue LT Std 57 Condensed
HEADINGS: 8 pt Helvetica Neue LT Std 77 Bold Condensed Oblique
SUBHEADINGS: 6 pt Helvetica Neue LT Std 77 Bold Condensed
TEXT: 6 pt Helvetica Neue LT Std 57 Condensed
LEADING: 6.5 pt
BULLETS: 5 pt Square with 2 M'S spacing between statements
TELEPHONE #: 6 pt Helvetica Neue LT Std 77 Bold Condensed
HEAVY LINES: 1.5 pt
HAIRLINES: 0.5 pt
Hairlines extend to within two spaces of the "Drug Facts" box



"This product is not manufactured or distributed by Takeda Pharmaceuticals U.S.A., Inc., owner of the registered trademark Prevacid®."

10 Hakdima Street, Yokneam 2069200, Israel
Deceel Pharma Technologies Ltd
Manufactured by:
Made in Israel

Location for
lot number and
expiration date



"This product is not manufactured or distributed by Takeda Pharmaceuticals U.S.A., Inc., owner of the registered trademark Prevacid®."

10 Hakdima Street, Yokneam 2069200, Israel
Deceel Pharma Technologies Ltd
Manufactured by:
Made in Israel

Location for
lot number and
expiration date



"This product is not manufactured or distributed by Takeda Pharmaceuticals U.S.A., Inc., owner of the registered trademark Prevacid®."

10 Hakdima Street, Yokneam 2069200, Israel
Deceel Pharma Technologies Ltd
Manufactured by:
Made in Israel

Location for
lot number and
expiration date



"This product is not manufactured or distributed by Takeda Pharmaceuticals U.S.A., Inc., owner of the registered trademark Prevacid®."

10 Hakdima Street, Yokneam 2069200, Israel
Deceel Pharma Technologies Ltd
Manufactured by:
Made in Israel

Location for
lot number and
expiration date

Lansoprazole
Delayed Release
Orally Disintegrating Tablets 15 mg

Drug Facts
Lansoprazole 15 mg.....Acid Reducer

Active Ingredient (in each tablet)

Purpose

Directions

14-Day Course of Treatment

take 1 tablet before eating in the morning

do not crush or chew tablets

place the tablet on tongue; tablet disintegrates, with or without water.

The tablets can also be swallowed whole with water.

take every day for 14 days

do not take more than 1 tablet a day

do not use for more than 14 days unless directed by your doctor

do not take this medicine with alcohol

Repeated 14-Day Course (if needed)

you may repeat a 14-day course every 4 months

do not take for more than 14 days or more often than every 4 months

unless directed by a doctor

children under 18 years of age: ask a doctor before use. Heartburn in children may sometimes be caused by a serious condition.

Other information

read the directions, warnings and package insert before use

keep the carton and package insert. They contain important information.

keep product out of high heat and humidity

protect product from moisture

Inactive ingredients ascorbic acid, cetyl alcohol, colloidal silicon dioxide, copovidone, croscopollose, flavor, hypromellose, hypromellose phthalate, maize starch, polyethylene glycol, silicon dioxide, sodium stearyl fumarate, sorbitol, sucralose, sugar spheres, talc, titanium dioxide, triethyl citrate

Questions or comments? 1-800-719-9260, weekdays 7:30 AM to 5:00 PM EST

Use

treats frequent heartburn (occurs 2 or more days a week)

not intended for immediate relief of heartburn; this drug may take 1 to 4 days for full effect

Warnings

do not use if you are allergic to lansoprazole

if you have trouble or pain swallowing food, vomiting with blood, or bloody or black stools. These may be signs of a serious condition. See your doctor.

Ask a doctor before use if you have

liver disease

had heartburn over 3 months. This may be a sign of a more serious condition.

heartburn with lightheadedness, sweating or dizziness

chest pain or shoulder pain with shortness of breath, sweating, pain spreading to arms, neck or shoulders, or rightheadedness

chest pain

frequent wheezing, particularly with heartburn

unexplained weight loss

nausea or vomiting

stomach pain

Ask a doctor or pharmacist before use if you are taking a prescription drug. Acid reducers may interact with certain prescription drugs.

Stop use and ask a doctor if

your heartburn continues or worsens

you need to take this product for more than 14 days

you need to take more than 1 course of treatment every 4 months

you get diarrhea

you develop a rash or joint pain

If pregnant or breast-feeding, ask a health care professional before use. Keep out of reach of children. In case of overdose, get medical help or contact a Poison Control Center right away (1-800-222-1222).



Lansoprazole
Delayed Release
Orally Disintegrating Tablets 15 mg

Safety Feature – Do not use if printed
tablet blister unit is open or torn.

KEEP THE CARTON AND PACKAGE INSERT.
THEY CONTAIN IMPORTANT INFORMATION.

NDC 64239-181-03

Treats Frequent Heartburn



Melts In Your Mouth

Compare to the active ingredient
in Prevacid® 24 HR*

Child-resistant

24 HR

Lansoprazole

Delayed Release
Orally Disintegrating Tablets 15 mg
Acid Reducer

May take 1 to 4 days for full effect

Dissolve Tabs

42 TABLETS

THREE 14-DAY COURSES
OF TREATMENT



Strawberry
Flavor



Actual
size

Melts in your mouth

Dissolves without water

STANDARD FORMAT

TYPE SIZES:

TITLE: 9 pt Helvetica Neue LT Std 77 Bold Condensed Oblique

TITLE (continued): 8 pt Helvetica Neue LT Std 77 Bold Condensed Oblique (continued) 8 pt Helvetica Neue LT Std 57 Condensed

HEADINGS: 8 pt Helvetica Neue LT Std 77 Bold Condensed Oblique

SUBHEADINGS: 6 pt Helvetica Neue LT Std 77 Bold Condensed

TEXT: 6 pt Helvetica Neue LT Std 57 Condensed

LEADING: 6.5 pt

BULLETS: 5 pt Square with 2 M'S spacing between statements

TELEPHONE #: 6 pt Helvetica Neue LT Std 77 Bold Condensed

HEAVY LINES: 1.5 pt

HAIRLINES: 0.5 pt

Hairlines extend to within two spaces of the "Drug Facts" box

Location for lot number and expiration date

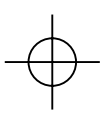
Lansoprazole
 Delayed Release
 Orally Disintegrating Tablets 15 mg

*This product is not manufactured or distributed by Takeda Pharmaceuticals U.S.A., Inc.,
 owner of the registered trademark Prevacid®.
 Manufactured by:
 Dexcel Pharma Technologies Ltd
 10 Hakdama Street, Yokneam 2069200, Israel
 Made in Israel

Drug Facts

Active ingredient (in each tablet) Lansoprazole 15 mg
Acid Reducer

Purpose

Use

- treats frequent heartburn (occurs 2 or more days a week)
- not intended for immediate relief of heartburn; this drug may take 1 to 4 days for full effect

Warnings

Allergy alert: do not use if you are allergic to lansoprazole

Do not use

- if you have trouble or pain swallowing food, vomiting with blood, or bloody or black stools. These may be signs of a serious condition. See your doctor.

Ask a doctor before use if you have

- liver disease
- had heartburn over 3 months. This may be a sign of a more serious condition.
- heartburn with **lightheadedness, sweating or dizziness**
- chest pain or shoulder pain with shortness of breath, sweating, pain spreading to arms, neck or shoulders, or rightheadedness
- frequent wheezing, particularly with heartburn
- unexplained weight loss
- nausea or vomiting ■ stomach pain

Ask a doctor or pharmacist before use if you are taking a prescription drug. Acid reducers may interact with certain prescription drugs.

Stop use and ask a doctor if

- your heartburn continues or worsens
- you need to take this product for more than 14 days
- you need to take more than 1 course of treatment every 4 months
- you get diarrhea
- you develop a rash or joint pain

If pregnant or breast-feeding, ask a health care professional before use.

Keep out of reach of children. In case of overdose, get medical help or contact a Poison Control Center right away (1-800-222-1222).

5:00 PM EST
Questions or comments? 1-800-719-9260; weekdays 7:30 AM to

Lansoprazole
 Delayed Release
 Orally Disintegrating Tablets 15 mg

 Safety Feature – Do not use if printed
 tablet blister unit is open or torn.

KEEP THE CARTON AND PACKAGE INSERT.
 THEY CONTAIN IMPORTANT INFORMATION.

 0000000000

NDC 64239-181-03
Treats Frequent Heartburn

 Compare to the active ingredient
 in Prevacid® 24 HR*
Bonus Pack: 28 + 14 Free
 **24 HR**
Lansoprazole
 Delayed Release
 Orally Disintegrating Tablets 15 mg
 Acid Reducer
 May take 1 to 4 days for full effect
Dissolve Tabs
42 TABLETS THREE 14-DAY COURSES
 OF TREATMENT
Melts in your mouth
 Dissolves without water

 Strawberry
 Flavor

 Actual
 size

 0000000000

STANDARD FORMAT

TYPE SIZES:
TITLE: 9 pt Helvetica Neue LT Std 77 Bold Condensed Oblique
 (continued); 8 pt Helvetica Neue LT Std 77 Bold Condensed Oblique
 (continued) 8 pt Helvetica Neue LT Std 57 Condensed
HEADINGS: 8 pt Helvetica Neue LT Std 77 Bold Condensed Oblique
SUBHEADINGS: 6 pt Helvetica Neue LT Std 77 Bold Condensed
TEXT: 6 pt Helvetica Neue LT Std 57 Condensed
LEADING: 6.5 pt
BULLETS: 5 pt Square with 2 M'S spacing between statements
TELEPHONE #: 6 pt Helvetica Neue LT Std 77 Bold Condensed
HEAVY LINES: 1.5 pt
HAIRLINES: 0.5 pt
 Hairlines extend to within two spaces of the "Drug Facts" box

Location for lot number and expiration date

8U155 FA C7-N 081320

Made in Israel

Manufactured by:
Dexcel Pharma Technologies Ltd
10 Hakdama Street, Yokneam 2069200, Israel

*This product is not manufactured or distributed by Takeda Pharmaceuticals U.S.A., Inc., owner of the registered trademark Prevacid®.

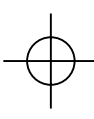

Drug Facts

Active ingredient (in each tablet)
Lansoprazole 15 mg;Acid Reducer

Use
■ treats frequent heartburn (occurs 2 or more days a week)
■ not intended for immediate relief of heartburn; this drug may take 1 to 4 days for full effect

Warnings
Allergy alert: do not use if you are allergic to lansoprazole

Do not use
■ if you have trouble or pain swallowing food, vomiting with blood, or bloody or black stools. These may be signs of a serious condition. See your doctor.

Ask a doctor before use if you have
■ liver disease
■ had heartburn over 3 months. This may be a sign of a more serious condition.
■ heartburn with **lightheadedness, sweating or dizziness**
■ chest pain or shoulder pain with shortness of breath, sweating, pain spreading to arms, neck or shoulders, or lightheadedness

Frequent chest pain
■ frequent wheezing, particularly with heartburn
■ unexplained weight loss
■ nausea or vomiting

Ask a doctor or pharmacist before use if you are taking a prescription drug.
Acid reducers may interact with certain prescription drugs.

Stop use and ask a doctor if
■ your heartburn continues or worsens
■ you need to take this product for more than 14 days
■ you need to take more than 1 course of treatment every 4 months
■ you get diarrhea
■ you develop a rash or joint pain

If pregnant or breast-feeding, ask a health care professional before use.
Keep out of reach of children. In case of overdose, get medical help or contact a Poison Control Center right away (1-800-222-1222).

5:00 PM EST
Questions or comments? 1-800-719-9260: weekdays 7:30 AM to

Drug Facts (continued)

Directions
this product is to be used once a day (every 24 hours), every day for 14 days; adults 18 years of age and older
it may take 1 to 4 days for full effect, although some people get complete relief of symptoms within 24 hours

14-Day Course of Treatment
■ take 1 tablet before eating in the morning
■ do not crush or chew tablets
■ place the tablet on tongue; tablet disintegrates, with or without water. The tablets can also be swallowed whole with water.

do not use
■ do not take more than 14 days unless directed by your doctor
■ do not take this medicine with alcohol

Repeated 14-Day Course (if needed)
■ you may repeat a 14-day course every 4 months
■ do not take for more than 14 days or more often than every 4 months unless directed by a doctor

■ children under 18 years of age: ask a doctor before use. Heartburn in children may sometimes be caused by a serious condition.

Other information
■ read the directions, warnings and package insert before use
■ keep the carton and package insert. They contain important information.
■ store at 20-25°C (68-77°F) ■ keep product out of high heat and humidity
■ protect product from moisture

Inactive ingredients ascorbic acid, cetyl alcohol, colloidal silicon dioxide, copovidone, croscopolone, flavor, hypromellose, hypromellose phthalate, mazelaloxazine, maltitol, mannitol, meglumine, microcrystalline cellulose, polyethylene glycol, silicon dioxide, sodium stearyl fumarate, softb, sucralose, sugar spheres, talc, titanium dioxide, triethyl citrate





Lansoprazole

Delayed Release
Orally Disintegrating Tablets 15 mg

Safety Feature – Do not use if printed tablet blister unit is open or torn.

KEEP THE CARTON AND PACKAGE INSERT. THEY CONTAIN IMPORTANT INFORMATION.

NDC 64239-181-03



Melts In Your Mouth

Treats Frequent Heartburn

Compare to the active ingredient in Prevacid® 24 HR*

Bonus Size!
14 Tablets Free



Strawberry Flavor



Lansoprazole

Delayed Release
Orally Disintegrating Tablets 15 mg
Acid Reducer

May take 1 to 4 days for full effect

Dissolve Tabs

42 TABLETS

THREE 14-DAY COURSES OF TREATMENT

Melts in your mouth

Dissolves without water



Actual size

STANDARD FORMAT

TYPE SIZES:

TITLE: 9 pt Helvetica Neue LT Std 77 Bold Condensed Oblique
TITLE (continued): 8 pt Helvetica Neue LT Std 77 Bold Condensed Oblique
(continued) 8 pt Helvetica Neue LT Std 57 Condensed
HEADINGS: 8 pt Helvetica Neue LT Std 77 Bold Condensed Oblique
SUBHEADINGS: 6 pt Helvetica Neue LT Std 77 Bold Condensed
TEXT: 6 pt Helvetica Neue LT Std 57 Condensed
LEADING: 6.5 pt
BULLETS: 5 pt Square with 2 M'S spacing between statements
TELEPHONE #: 6 pt Helvetica Neue LT Std 77 Bold Condensed
HEAVY LINES: 1.5 pt
HAIRLINES: 0.5 pt
Hairlines extend to within two spaces of the "Drug Facts" box



*This product is not manufactured or distributed by Takeda Pharmaceuticals U.S.A., Inc.,
owner of the registered trademark Prevacid®.

10 Hakima Street, Yokneam 2069200, Israel
Dexcel Pharma Technologies Ltd
Manufactured by:
Made in Israel

Location for
lot number and
expiration date

Lansoprazole

Delayed Release
Orally Disintegrating Tablets 15 mg

5:00 PM EST
▲ **Questions or comments?** 1-800-719-9260; weekdays 7:30 AM to

Inactive ingredients ascorbic acid, cetyl alcohol, colloidal silicon dioxide, copovidone, croscopollose, flavor, hypromellose, hypromellose phthalate, maize starch, polyethylene glycol, silicon dioxide, sodium stearyl fumarate, sorbitol, sucralose, sugar spheres, talc, titanium dioxide, triethyl citrate

Other information

- children under 18 years of age: ask a doctor before use. Heartburn in children may sometimes be caused by a serious condition.
- unless directed by a doctor
- do not take for more than 14 days or more often than every 4 months
- you may repeat a 14-day course every 4 months
- Repeated 14-Day Course (if needed)
- do not take this medicine with alcohol
- do not use for more than 14 days unless directed by your doctor
- take every day for 14 days
- take every day for 14 days
- place the tablet on tongue; tablet disintegrates, with or without water. The tablets can also be swallowed whole with water.
- do not crush or chew tablets
- take 1 tablet before eating in the morning

14-Day Course of Treatment

- relief of symptoms within 24 hours
- it may take 1 to 4 days for full effect, although some people get complete relief of symptoms within 24 hours

Directions

- adults 18 years of age and older

Drug Facts (continued)

Active ingredient (in each tablet) Lansoprazole 15 mg.....Acid Reducer

Purpose Acid Reducer

Use

- treats frequent heartburn (occurs 2 or more days a week)
- not intended for immediate relief of heartburn; this drug may take 1 to 4 days for full effect

Warnings

- if you have trouble or pain swallowing food, vomiting with blood, or bloody or black stools. These may be signs of a serious condition. See your doctor.

Ask a doctor before use if you have

- liver disease
- had heartburn over 3 months. This may be a sign of a more serious condition.
- heartburn with lightheadedness, sweating or dizziness
- chest pain or shoulder pain with shortness of breath; sweating; pain spreading to arms, neck or shoulders; or lightheadedness

Ask a doctor or pharmacist before use if you are taking a prescription drug.

- frequent chest pain
- frequent wheezing, particularly with heartburn
- unexplained weight loss
- nausea or vomiting
- stomach pain

Stop use and ask a doctor if

- your heartburn continues or worsens
- you need to take this product for more than 14 days
- you need to take more than 1 course of treatment every 4 months
- you get diarrhea
- you develop a rash or joint pain

If pregnant or breast-feeding, ask a health care professional before use.

Keep out of reach of children. In case of overdose, get medical help or contact a Poison Control Center right away (1-800-222-1222).



Lansoprazole

Delayed Release
Orally Disintegrating Tablets 15 mg

Safety Feature – Do not use if printed
tablet blister unit is open or torn.

KEEP THE CARTON AND PACKAGE INSERT.
THEY CONTAIN IMPORTANT INFORMATION.

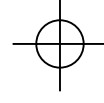

NDC 64239-181-03

Treats Frequent Heartburn



Compare to the active ingredient
in Prevacid® 24 HR*

Bonus Size! 14 Free

24 HR

Lansoprazole

Delayed Release
Orally Disintegrating Tablets 15 mg
Acid Reducer



Strawberry
Flavor

May take 1 to 4 days for full effect

Dissolve Tabs

42 TABLETS

THREE 14-DAY COURSES
OF TREATMENT

Melts in your mouth
Dissolves without water

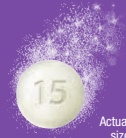

Actual
size

STANDARD FORMAT

TYPE SIZES:

TITLE: 9 pt Helvetica Neue LT Std 77 Bold Condensed Oblique
TITLE (continued): 8 pt Helvetica Neue LT Std 77 Bold Condensed Oblique
(continued) 8 pt Helvetica Neue LT Std 57 Condensed
HEADINGS: 8 pt Helvetica Neue LT Std 77 Bold Condensed Oblique
SUBHEADINGS: 6 pt Helvetica Neue LT Std 77 Bold Condensed
TEXT: 6 pt Helvetica Neue LT Std 57 Condensed
LEADING: 6.5 pt
BULLETS: 5 pt Square with 2 M'S spacing between statements
TELEPHONE #: 6 pt Helvetica Neue LT Std 77 Bold Condensed
HEAVY LINES: 1.5 pt
HAIRLINES: 0.5 pt
Hairlines extend to within two spaces of the "Drug Facts" box



*This product is not manufactured or distributed by Takeda Pharmaceuticals U.S.A., Inc.,
owner of the registered trademark Prevacid®.

Manufactured by:
Deccel Pharma Technologies Ltd
10 Hekidma Street, Yokneam 2069200, Israel

Made in Israel

Location for
lot number and
expiration date

Lansoprazole

Delayed Release
Orally Disintegrating Tablets 15 mg

<p>Drug Facts (continued)</p> <p>Active ingredient (in each tablet) Lansoprazole 15 mg.....Acid Reducer</p> <p>Purpose Acid Reducer</p> <p>Directions ■ adults 18 years of age and older ■ this product is to be used once a day (every 24 hours), every day for 14 days ■ it may take 1 to 4 days for full effect, although some people get complete relief of symptoms within 24 hours</p> <p>14-Day Course of Treatment ■ take 1 tablet before eating in the morning</p> <p>do not crush or chew tablets ■ place the tablet on tongue; tablet disintegrates, with or without water. The tablets can also be swallowed whole with water.</p> <p>do not use ■ if you have trouble or pain swallowing food, vomiting with blood, or bloody or black stools. These may be signs of a serious condition. See your doctor.</p> <p>Ask a doctor before use if you have ■ liver disease ■ had heartburn over 3 months. This may be a sign of a more serious condition. ■ heartburn with lightheadedness, sweating or dizziness ■ chest pain or shoulder pain with shortness of breath; sweating; pain spreading to arms, neck or shoulders, or lightheadedness</p> <p>Ask a doctor before use if you are taking a prescription drug. Acid reducers may interact with certain prescription drugs.</p> <p>Stop use and ask a doctor if ■ your heartburn continues or worsens ■ you need to take this product for more than 14 days ■ you need to take more than 1 course of treatment every 4 months ■ you get diarrhea ■ you develop a rash or joint pain</p> <p>If pregnant or breast-feeding, ask a health care professional before use. Keep out of reach of children. In case of overdose, get medical help or contact a Poison Control Center right away (1-800-222-1222).</p> <p>Questions or comments? 1-800-719-9260. weekdays 7:30 AM to 5:00 PM EST</p>	<p>Warnings ■ do not use if you are allergic to lansoprazole</p> <p>Use ■ treats frequent heartburn (occurs 2 or more days a week) ■ not intended for immediate relief of heartburn; this drug may take 1 to 4 days for full effect</p> <p>Warnings ■ do not use if you are allergic to lansoprazole</p> <p>Do not use ■ if you have trouble or pain swallowing food, vomiting with blood, or bloody or black stools. These may be signs of a serious condition. See your doctor.</p> <p>Ask a doctor before use if you have ■ liver disease ■ had heartburn over 3 months. This may be a sign of a more serious condition. ■ heartburn with lightheadedness, sweating or dizziness ■ chest pain or shoulder pain with shortness of breath; sweating; pain spreading to arms, neck or shoulders, or lightheadedness</p> <p>Ask a doctor or pharmacist before use if you are taking a prescription drug. Acid reducers may interact with certain prescription drugs.</p> <p>Stop use and ask a doctor if ■ your heartburn continues or worsens ■ you need to take this product for more than 14 days ■ you need to take more than 1 course of treatment every 4 months ■ you get diarrhea ■ you develop a rash or joint pain</p> <p>If pregnant or breast-feeding, ask a health care professional before use. Keep out of reach of children. In case of overdose, get medical help or contact a Poison Control Center right away (1-800-222-1222).</p>
---	--

Location for
lot number and
expiration date



Lansoprazole

Delayed Release
Orally Disintegrating Tablets 15 mg

Safety Feature – Do not use if printed
tablet blister unit is open or torn.

KEEP THE CARTON AND PACKAGE INSERT.
THEY CONTAIN IMPORTANT INFORMATION.



Lansoprazole

Delayed Release
Orally Disintegrating Tablets 15 mg
Acid Reducer

May take 1 to 4 days for full effect

Dissolve Tabs

42 TABLETS

THREE 14-DAY COURSES
OF TREATMENT

Treats Frequent Heartburn

24 HR

Lansoprazole

Delayed Release
Orally Disintegrating Tablets 15 mg
Acid Reducer

May take 1 to 4 days for full effect

Dissolve Tabs

42 TABLETS

THREE 14-DAY COURSES
OF TREATMENT

MELTech™

Melts In Your Mouth

Compare to the active ingredient
in Prevacid® 24 HR*

Bonus! + 14 Free



Strawberry
Flavor



Actual
size

STANDARD FORMAT

TYPE SIZES:
TITLE: 9 pt Helvetica Neue LT Std 77 Bold Condensed Oblique
TITLE (continued): 8 pt Helvetica Neue LT Std 77 Bold Condensed Oblique
 (continued) 8 pt Helvetica Neue LT Std 57 Condensed
HEADINGS: 8 pt Helvetica Neue LT Std 77 Bold Condensed Oblique
SUBHEADINGS: 6 pt Helvetica Neue LT Std 77 Bold Condensed
TEXT: 6 pt Helvetica Neue LT Std 57 Condensed
LEADING: 6.5 pt
BULLETS: 5 pt Square with 2 M'S spacing between statements
TELEPHONE #: 6 pt Helvetica Neue LT Std 77 Bold Condensed
HEAVY LINES: 1.5 pt
HAIRLINES: 0.5 pt
 Hairlines extend to within two spaces of the "Drug Facts" box

Location for lot number and expiration date

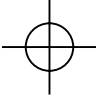

Manufactured by:
Cexcel Pharma Technologies Ltd
10 Hakdima Street, Yokneam 2069200, Israel

*This product is not manufactured or distributed by Takeda Pharmaceuticals U.S.A., Inc., owner of the registered trademark Prevacid®.

Lansoprazole
Delayed Release
Orally Disintegrating Tablets 15 mg

<p>Drug Facts</p> <p>Active ingredient (in each tablet) Lansoprazole 15 mg.....Acid Reducer</p> <p>Use</p> <ul style="list-style-type: none"> ■ treats frequent heartburn (occurs 2 or more days a week) ■ not intended for immediate relief of heartburn; this drug may take 1 to 4 days for full effect <p>Warnings</p> <p>Allergy alert: do not use if you are allergic to lansoprazole</p> <p>Do not use</p> <ul style="list-style-type: none"> ■ if you have trouble or pain swallowing food, vomiting, or bloody or black stools. These may be signs of a serious condition. See your doctor. ■ do not take more than 1 tablet a day ■ do not use for more than 14 days unless directed by your doctor. ■ do not take this medicine with alcohol <p>Ask a doctor before use if you have</p> <ul style="list-style-type: none"> ■ liver disease ■ had heartburn over 3 months. This may be a sign of a more serious condition. ■ heartburn with lightheadedness, sweating or dizziness ■ chest pain or shoulder pain with shortness of breath; sweating; pain spreading to arms, neck or shoulders; or lightheadedness ■ frequent wheezing, particularly with heartburn ■ unexplained weight loss ■ nausea or vomiting ■ stomach pain <p>Ask a doctor or pharmacist before use if you are taking a prescription drug. Acid reducers may interact with certain prescription drugs.</p> <p>Stop use and ask a doctor if</p> <ul style="list-style-type: none"> ■ your heartburn continues or worsens ■ you need to take this product for more than 14 days ■ you need to take more than 1 course of treatment every 4 months ■ you get diarrhea ■ you develop a rash or joint pain <p>If pregnant or breast-feeding, ask a health care professional before use. Keep out of reach of children. In case of overdose, get medical help or contact a Poison Control Center right away (1-800-222-1222).</p>	<p>Drug Facts (continued)</p> <p>Directions</p> <ul style="list-style-type: none"> ■ adults 18 years of age and older ■ this product is to be used once a day (every 24 hours), every day for 14 days ■ it may take 1 to 4 days for full effect, although some people get complete relief of symptoms within 24 hours <p>14-Day Course of Treatment</p> <ul style="list-style-type: none"> ■ take 1 tablet before eating in the morning ■ do not crush or chew tablets ■ place the tablet on tongue; tablet disintegrates, with or without water. The tablets can also be swallowed whole with water. ■ take every day for 14 days ■ do not take more than 1 tablet a day ■ do not use for more than 14 days unless directed by your doctor. ■ do not take this medicine with alcohol <p>Repeated 14-Day Course (if needed)</p> <ul style="list-style-type: none"> ■ you may repeat a 14-day course every 4 months ■ do not take for more than 14 days or more often than every 4 months unless directed by a doctor <ul style="list-style-type: none"> ■ children under 18 years of age: ask a doctor before use. Heartburn in children may sometimes be caused by a serious condition. <p>Other information</p> <ul style="list-style-type: none"> ■ read the directions, warnings and package insert before use ■ keep the carton and package insert. They contain important information. ■ store at 20-25°C (68-77°F) ■ keep product out of high heat and humidity ■ protect product from moisture <p>Inactive ingredients ascorbic acid, cetyl alcohol, colloidal silicon dioxide, copovidone, croscopolone, flavor, hypromellose, hypromellose phthalate, maize polyborate 60, polyethylene glycol, silicon dioxide, sodium stearyl fumarate, sorbitol, sucralose, sugar spheres, talc, titanium dioxide, triethyl citrate</p> <p>Questions or comments? 1-800-719-9260, weekdays 7:30 AM to 5:00 PM EST</p>
---	--

8U155 FA C7-S 081320



Lansoprazole

Delayed Release
Orally Disintegrating Tablets 15 mg

Safety Feature – Do not use if printed tablet blister unit is open or torn.

KEEP THE CARTON AND PACKAGE INSERT.
THEY CONTAIN IMPORTANT INFORMATION.

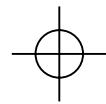



NDC 64239-181-03

Treats Frequent Heartburn

MELTech™
Melts In Your Mouth

Compare to the active ingredient in Prevacid® 24 HR*

Bonus! 14 Tablets FREE

24 HR

Lansoprazole

Delayed Release
Orally Disintegrating Tablets 15 mg
Acid Reducer

May take 1 to 4 days for full effect

Dissolve Tabs

42 TABLETS

THREE 14-DAY COURSES OF TREATMENT

Melts in your mouth

Dissolves without water



Strawberry Flavor



Actual size

STANDARD FORMAT

TYPE SIZES:
TITLE: 9 pt Helvetica Neue LT Std 77 Bold Condensed Oblique
TITLE (continued): 8 pt Helvetica Neue LT Std 77 Bold Condensed Oblique
(continued) 8 pt Helvetica Neue LT Std 57 Condensed
HEADINGS: 8 pt Helvetica Neue LT Std 77 Bold Condensed Oblique
SUBHEADINGS: 6 pt Helvetica Neue LT Std 77 Bold Condensed
TEXT: 6 pt Helvetica Neue LT Std 57 Condensed
LEADING: 6.5 pt
BULLETS: 5 pt Square with 2 M'S spacing between statements
TELEPHONE #: 6 pt Helvetica Neue LT Std 77 Bold Condensed
HEAVY LINES: 1.5 pt
HAIRLINES: 0.5 pt
 Hairlines extend to within two spaces of the "Drug Facts" box

This is a representation of an electronic record that was signed electronically. Following this are manifestations of any and all electronic signatures for this electronic record.

/s/

NUSHIN F TODD
11/20/2020 03:21:43 PM