

## HIGHLIGHTS OF PRESCRIBING INFORMATION

These highlights do not include all the information needed to use HYRIMOZ™ safely and effectively. See full prescribing information for HYRIMOZ .

HYRIMOZ (adalimumab-adaz) injection, for subcutaneous use

Initial U.S. Approval: 2018

HYRIMOZ (adalimumab-adaz) is biosimilar\* to HUMIRA (adalimumab)

**WARNING: SERIOUS INFECTIONS AND MALIGNANCY**  
See full prescribing information for complete boxed warning.

### SERIOUS INFECTIONS (5.1, 6.1):

- Increased risk of serious infections leading to hospitalization or death, including tuberculosis (TB), bacterial sepsis, invasive fungal infections (such as histoplasmosis), and infections due to other opportunistic pathogens.
- Discontinue HYRIMOZ if a patient develops a serious infection or sepsis during treatment.
- Perform test for latent TB; if positive, start treatment for TB prior to starting HYRIMOZ.
- Monitor all patients for active TB during treatment, even if initial latent TB test is negative.

### MALIGNANCY (5.2):

- Lymphoma and other malignancies, some fatal, have been reported in children and adolescent patients treated with TNF-blockers including adalimumab products.
- Post-marketing cases of hepatosplenic T-cell lymphoma (HSTCL), a rare type of T-cell lymphoma, have occurred in adolescent and young adults with inflammatory bowel disease treated with TNF-blockers including adalimumab products.

## INDICATIONS AND USAGE

HYRIMOZ is a tumor necrosis factor (TNF)-blocker indicated for treatment of:

- Rheumatoid Arthritis (RA) (1.1):** Reducing signs and symptoms, inducing major clinical response, inhibiting the progression of structural damage, and improving physical function in adult patients with moderately to severely active RA.
- Juvenile Idiopathic Arthritis (JIA) (1.2):** Reducing signs and symptoms of moderately to severely active polyarticular JIA in patients 4 years of age and older.
- Psoriatic Arthritis (PsA) (1.3):** Reducing signs and symptoms, inhibiting the progression of structural damage, and improving physical function in adult patients with active PsA.
- Ankylosing Spondylitis (AS) (1.4):** Reducing signs and symptoms in adult patients with active AS.
- Adult Crohn's Disease (CD) (1.5):** Reducing signs and symptoms and inducing and maintaining clinical remission in adult patients with moderately to severely active Crohn's Disease who have had an inadequate response to conventional therapy. Reducing signs and symptoms and inducing clinical remission in these patients if they have also lost response to or are intolerant to infliximab.
- Ulcerative Colitis (UC) (1.7):** Inducing and sustaining clinical remission in adult patients with moderately to severely active ulcerative colitis who have had an inadequate response to immunosuppressants such as corticosteroids, azathioprine or 6-mercaptopurine (6-MP). The effectiveness of HYRIMOZ has not been established in patients who have lost response to or were intolerant to TNF-blockers.
- Plaque Psoriasis (Ps) (1.8):** The treatment of adult patients with moderate to severe chronic plaque psoriasis who are candidates for systemic therapy or phototherapy, and when other systemic therapies are medically less appropriate.

## DOSAGE AND ADMINISTRATION

- Administered by subcutaneous injection (2)
- Rheumatoid Arthritis, Psoriatic Arthritis, Ankylosing Spondylitis (2.1):**
- 40 mg every other week.
    - Some patients with RA not receiving methotrexate may benefit from increasing the frequency to 40 mg every week.
- Juvenile Idiopathic Arthritis (2.2):**
- ≥ 30 kg (66 lbs): 40 mg every other week

## Adult Crohn's Disease and Ulcerative Colitis (2.3, 2.5):

- Initial dose (Day 1): 160 mg (four 40 mg injections in one day or two 40 mg injections per day for two consecutive days)
- Second dose two weeks later (Day 15): 80 mg
  - Two weeks later (Day 29): Begin a maintenance dose of 40 mg every other week.
- For patients with Ulcerative Colitis only: Only continue HYRIMOZ in patients who have shown evidence of clinical remission by eight weeks (Day 57) of therapy.

## Plaque Psoriasis (2.6):

- 80 mg initial dose, followed by 40 mg every other week starting one week after initial dose.

## DOSAGE FORMS AND STRENGTHS

- Injection: 40 mg/0.8 mL in a single-dose pre-filled glass syringe (with BD UltraSafe Passive™ Needle Guard) (3)
- Injection: 40 mg/0.8 mL in a single-dose pre-filled pen (Sensoready® Pen) (3)

## CONTRAINDICATIONS

None (4)

## WARNINGS AND PRECAUTIONS

- Serious infections:** Do not start HYRIMOZ during an active infection. If an infection develops, monitor carefully, and stop HYRIMOZ if infection becomes serious (5.1)
- Invasive fungal infections:** For patients who develop a systemic illness on HYRIMOZ, consider empiric antifungal therapy for those who reside or travel to regions where mycoses are endemic (5.1)
- Malignancies:** Incidence of malignancies was greater in adalimumab - treated patients than in controls (5.2)
- Anaphylaxis or serious allergic reactions** may occur (5.3)
- Hepatitis B virus reactivation:** Monitor HBV carriers during and several months after therapy. If reactivation occurs, stop HYRIMOZ and begin anti-viral therapy (5.4)
- Demyelinating disease:** Exacerbation or new onset, may occur (5.5)
- Cytopenias, pancytopenia:** Advise patients to seek immediate medical attention if symptoms develop, and consider stopping HYRIMOZ (5.6)
- Heart failure:** Worsening or new onset, may occur (5.8)
- Lupus-like syndrome:** Stop HYRIMOZ if syndrome develops (5.9)

## ADVERSE REACTIONS

Most common adverse reactions (incidence > 10 %): infections (e.g. upper respiratory, sinusitis), injection site reactions, headache and rash (6.1)

To report SUSPECTED ADVERSE REACTIONS, contact Sandoz Inc. at 1-800-525-8747 or FDA at 1-800-FDA-1088 or [www.fda.gov/medwatch](http://www.fda.gov/medwatch)

## DRUG INTERACTIONS

- Abatacept:** Increased risk of serious infection (5.1, 5.11, 7.2)
- Anakinra:** Increased risk of serious infection (5.1, 5.7, 7.2)
- Live vaccines:** Avoid use with HYRIMOZ (5.10, 7.3)

See 17 for PATIENT COUNSELING INFORMATION and Medication Guide

\* Biosimilar means that the biological product is approved based on data demonstrating that it is highly similar to an FDA-approved biological product known as a reference product, and that there are no clinically meaningful differences between the biosimilar product and the reference product. Biosimilarity of HYRIMOZ has been demonstrated for the condition(s) of use (e.g. indication(s), dosing regimen(s)), strength(s), dosage form(s), and route(s) of administration described in its Full Prescribing Information.

Revised: 02/2021

**FULL PRESCRIBING INFORMATION: CONTENTS\***

**WARNING: SERIOUS INFECTIONS AND MALIGNANCY**

**1 INDICATIONS AND USAGE**

- 1.1 Rheumatoid Arthritis
- 1.2 Juvenile Idiopathic Arthritis
- 1.3 Psoriatic Arthritis
- 1.4 Ankylosing Spondylitis
- 1.5 Adult Crohn's Disease
- 1.7 Ulcerative Colitis
- 1.8 Plaque Psoriasis

**2 DOSAGE AND ADMINISTRATION**

- 2.1 Rheumatoid Arthritis, Psoriatic Arthritis, and Ankylosing Spondylitis
- 2.2 Juvenile Idiopathic Arthritis
- 2.3 Adult Crohn's Disease
- 2.4 Ulcerative Colitis
- 2.5 Plaque Psoriasis
- 2.6 Monitoring to Assess Safety
- 2.7 General Considerations for Administration

**3 DOSAGE FORMS AND STRENGTHS**

**4 CONTRAINDICATIONS**

**5 WARNINGS AND PRECAUTIONS**

- 5.1 Serious Infections
- 5.2 Malignancies
- 5.3 Hypersensitivity Reactions
- 5.4 Hepatitis B Virus Reactivation
- 5.5 Neurologic Reactions
- 5.6 Hematological Reactions
- 5.7 Use with Anakinra
- 5.8 Heart Failure
- 5.9 Autoimmunity
- 5.10 Immunizations
- 5.11 Use with Abatacept

**6 ADVERSE REACTIONS**

- 6.1 Clinical Trials Experience
- 6.2 Postmarketing Experience

**7 DRUG INTERACTIONS**

- 7.1 Methotrexate
- 7.2 Biological Products
- 7.3 Live Vaccines
- 7.4 Cytochrome P450 Substrates

**8 USE IN SPECIFIC POPULATIONS**

- 8.1 Pregnancy
- 8.2 Lactation
- 8.4 Pediatric Use
- 8.5 Geriatric Use

**10 OVERDOSAGE**

**11 DESCRIPTION**

**12 CLINICAL PHARMACOLOGY**

- 12.1 Mechanism of Action
- 12.2 Pharmacodynamics
- 12.3 Pharmacokinetics

**13 NONCLINICAL TOXICOLOGY**

- 13.1 Carcinogenesis, Mutagenesis, Impairment of Fertility

**14 CLINICAL STUDIES**

- 14.1 Rheumatoid Arthritis
- 14.2 Juvenile Idiopathic Arthritis
- 14.3 Psoriatic Arthritis
- 14.4 Ankylosing Spondylitis
- 14.5 Adult Crohn's Disease
- 14.7 Ulcerative Colitis
- 14.8 Plaque Psoriasis

**15 REFERENCES**

**16 HOW SUPPLIED/STORAGE AND HANDLING**

**17 PATIENT COUNSELING INFORMATION**

\*Sections or subsections omitted from the full prescribing information are not listed

---

## FULL PRESCRIBING INFORMATION

### WARNING: SERIOUS INFECTIONS and MALIGNANCY

#### SERIOUS INFECTIONS

Patients treated with adalimumab products including HYRIMOZ, are at increased risk for developing serious infections that may lead to hospitalization or death [*see Warnings and Precautions (5.1)*]. Most patients who developed these infections were taking concomitant immunosuppressants such as methotrexate or corticosteroids.

Discontinue HYRIMOZ if a patient develops a serious infection or sepsis.

Reported infections include:

- Active tuberculosis (TB), including reactivation of latent TB. Patients with TB have frequently presented with disseminated or extrapulmonary disease. Test patients for latent TB before HYRIMOZ use and during therapy. Initiate treatment for latent TB prior to HYRIMOZ use.
- Invasive fungal infections, including histoplasmosis, coccidioidomycosis, candidiasis, aspergillosis, blastomycosis, and pneumocystosis. Patients with histoplasmosis or other invasive fungal infections may present with disseminated, rather than localized, disease. Antigen and antibody testing for histoplasmosis may be negative in some patients with active infection. Consider empiric anti-fungal therapy in patients at risk for invasive fungal infections who develop severe systemic illness.
- Bacterial, viral and other infections due to opportunistic pathogens, including Legionella and Listeria.

Carefully consider the risks and benefits of treatment with HYRIMOZ prior to initiating therapy in patients with chronic or recurrent infection.

Monitor patients closely for the development of signs and symptoms of infection during and after treatment with HYRIMOZ, including the possible development of TB in patients who tested negative for latent TB infection prior to initiating therapy [*see Warnings and Precautions (5.1) and Adverse Reactions (6.1)*].

#### MALIGNANCY

Lymphoma and other malignancies, some fatal, have been reported in children and adolescent patients treated with TNF-blockers including adalimumab products [*see Warnings and Precautions (5.2)*]. Post-marketing cases of hepatosplenic T-cell lymphoma (HSTCL), a rare type of T-cell lymphoma, have been reported in patients treated with TNF-blockers including adalimumab products. These cases have had a very aggressive disease course and have been fatal. The majority of reported TNF-blocker cases have occurred in patients with Crohn's disease or ulcerative colitis and the majority were in adolescent and young adult males. Almost all these patients had received treatment with azathioprine or 6-mercaptopurine (6-MP) concomitantly with a TNF-blocker at or prior to diagnosis. It is uncertain whether the occurrence of HSTCL is related to use of a TNF-blocker or a TNF-blocker in combination with these other immunosuppressants [*see Warnings and Precautions (5.2)*].

## 1 INDICATIONS AND USAGE

### 1.1 Rheumatoid Arthritis

HYRIMOZ is indicated for reducing signs and symptoms, inducing major clinical response, inhibiting the progression of structural damage, and improving physical function in adult patients with moderately to severely active rheumatoid arthritis. HYRIMOZ can be used alone or in combination with methotrexate or other non-biologic disease-modifying anti-rheumatic drugs (DMARDs).

### 1.2 Juvenile Idiopathic Arthritis

HYRIMOZ is indicated for reducing signs and symptoms of moderately to severely active polyarticular juvenile idiopathic arthritis in patients 4 years of age and older. HYRIMOZ can be used alone or in combination with methotrexate.

### 1.3 Psoriatic Arthritis

HYRIMOZ is indicated for reducing signs and symptoms, inhibiting the progression of structural damage, and improving physical function in adult patients with active psoriatic arthritis. HYRIMOZ can be used alone or in combination with non-biologic DMARDs.

### 1.4 Ankylosing Spondylitis

HYRIMOZ is indicated for reducing signs and symptoms in adult patients with active ankylosing spondylitis.

### 1.5 Adult Crohn's Disease

HYRIMOZ is indicated for reducing signs and symptoms and inducing and maintaining clinical remission in adult patients with moderately to severely active Crohn's disease who have had an inadequate response to conventional therapy. HYRIMOZ is indicated for reducing signs and symptoms and inducing clinical remission in these patients if they have also lost response to or are intolerant to infliximab.

### 1.6 Ulcerative Colitis

HYRIMOZ is indicated for inducing and sustaining clinical remission in adult patients with moderately to severely active ulcerative colitis who have had an inadequate response to immunosuppressants such as corticosteroids, azathioprine or 6-mercaptopurine (6-MP). The effectiveness of HYRIMOZ has not been established in patients who have lost response to or were intolerant to TNF-blockers [*see Clinical Studies (14.7)*].

### 1.7 Plaque Psoriasis

HYRIMOZ is indicated for the treatment of adult patients with moderate to severe chronic plaque psoriasis who are candidates for systemic therapy or phototherapy, and when other systemic therapies are medically less appropriate. HYRIMOZ should only be administered to patients who will be closely monitored and have regular follow-up visits with a physician [*see [Boxed Warning](#) and [Warnings and Precautions \(5\)](#)*].

## 2 DOSAGE AND ADMINISTRATION

HYRIMOZ is administered by subcutaneous injection.

### 2.1 Rheumatoid Arthritis, Psoriatic Arthritis, and Ankylosing Spondylitis

The recommended dose of HYRIMOZ for adult patients with rheumatoid arthritis (RA), psoriatic arthritis (PsA), or ankylosing spondylitis (AS) is 40 mg administered every other week. Methotrexate (MTX), other non-biologic DMARDs, glucocorticoids, nonsteroidal anti-inflammatory drugs (NSAIDs), and/or analgesics may be continued during treatment with HYRIMOZ. In the treatment of RA, some patients not taking concomitant MTX may derive additional benefit from increasing the dosing frequency of HYRIMOZ to 40 mg every week.

## 2.2 Juvenile Idiopathic Arthritis

The recommended dose of HYRIMOZ for patients 4 years of age and older with polyarticular juvenile idiopathic arthritis (JIA) is based on weight as shown below. MTX, glucocorticoids, NSAIDs, and/or analgesics may be continued during treatment with HYRIMOZ.

<b>Patients (4 years of age and older)</b>	<b>Dose</b>
≥30 kg (66 lbs)	40 mg every other week (HYRIMOZ single-dose pre-filled Sensoready® Pen or HYRIMOZ single-dose pre-filled syringe)

Healthcare providers should be advised that there is no dosage form for HYRIMOZ that allows weight-based dosing for pediatric patients below 30 kg.

Adalimumab products have not been studied in patients with polyarticular JIA less than 2 years of age or in patients with a weight below 10 kg.

## 2.3 Adult Crohn's Disease

The recommended HYRIMOZ dose regimen for adult patients with Crohn's disease (CD) is 160 mg initially on Day 1 (given as four 40 mg injections in one day or as two 40 mg injections per day for two consecutive days), followed by 80 mg two weeks later (Day 15). Two weeks later (Day 29) begin a maintenance dose of 40 mg every other week. Aminosalicylates and/or corticosteroids may be continued during treatment with HYRIMOZ. Azathioprine, 6-mercaptopurine (6-MP) [*see Warnings and Precautions (5.2)*] or MTX may be continued during treatment with HYRIMOZ if necessary. The use of adalimumab products in CD beyond one year has not been evaluated in controlled clinical studies.

## 2.4 Ulcerative Colitis

The recommended HYRIMOZ dose regimen for adult patients with ulcerative colitis (UC) is 160 mg initially on Day 1 (given as four 40 mg injections in one day or as two 40 mg injections per day for two consecutive days), followed by 80 mg two weeks later (Day 15). Two weeks later (Day 29) continue with a dose of 40 mg every other week.

Only continue HYRIMOZ in patients who have shown evidence of clinical remission by eight weeks (Day 57) of therapy. Aminosalicylates and/or corticosteroids may be continued during treatment with HYRIMOZ. Azathioprine and 6-mercaptopurine (6-MP) [*see Warnings and Precautions (5.2)*] may be continued during treatment with HYRIMOZ if necessary.

## 2.5 Plaque Psoriasis

The recommended dose of HYRIMOZ for adult patients with plaque psoriasis (Ps) is an initial dose of 80 mg, followed by 40 mg given every other week starting one week after the initial dose. The use of adalimumab products in moderate to severe chronic Ps beyond one year has not been evaluated in controlled clinical studies.

## 2.6 Monitoring to Assess Safety

Prior to initiating HYRIMOZ and periodically during therapy, evaluate patients for active tuberculosis and test for latent infection [*see Warnings and Precautions (5.1)*].

## 2.7 General Considerations for Administration

HYRIMOZ is intended for use under the guidance and supervision of a physician. A patient may self-inject HYRIMOZ or a caregiver may inject HYRIMOZ using either the HYRIMOZ single-dose pre-filled Sensoready® Pen or the HYRIMOZ single-dose pre-filled syringe with needle guard and add-on

finger flange if a physician determines that it is appropriate, and with medical follow-up, as necessary, after proper training in subcutaneous injection technique.

You may leave HYRIMOZ at room temperature for about 15 to 30 minutes before injecting. Do not remove the cap while allowing it to reach room temperature. Carefully inspect the solution in the HYRIMOZ single-dose pre-filled Sensoready® Pen or HYRIMOZ single-dose pre-filled syringe for particulate matter and discoloration prior to subcutaneous administration. The solution should be clear, colorless to slightly yellowish. Do not use if particulates and/or discolorations are observed. HYRIMOZ does not contain preservatives; therefore, discard unused portions of drug remaining from the syringe.

NOTE: Advise latex-sensitive patients that the following components contain dry natural rubber (a derivative of latex) that may cause allergic reactions in individuals sensitive to latex: the gray needle cap of the HYRIMOZ single-dose pre-filled syringe and the gray needle cover within the needle cap of the HYRIMOZ single-dose pre-filled Sensoready® Pen [see *How Supplied/Storage and Handling* ([16](#)) for specific information].

Instruct patients using the HYRIMOZ single-dose pre-filled Sensoready® Pen and the HYRIMOZ single-dose pre-filled syringe to inject the full amount according to the directions provided in the Instructions for Use [see *Instructions for Use*].

Injections should occur at separate sites in the thigh or abdomen. Rotate injection sites and do not give injections into areas where the skin is tender, bruised, red or hard.

### 3 DOSAGE FORMS AND STRENGTHS

- **HYRIMOZ single-dose pre-filled Sensoready® Pen**

Injection: 40 mg/0.8 mL of HYRIMOZ is provided by a single-dose pen (Sensoready® Pen), containing a 1 mL pre-filled glass syringe with a fixed 27-gauge, ½ -inch needle and a gray needle cover.

- **HYRIMOZ single-dose pre-filled syringe with BD UltraSafe Passive™ Needle Guard**

Injection: 40 mg/0.8 mL of HYRIMOZ is provided by a single-dose, 1 mL pre-filled glass syringe with a needle guard and add-on finger flange, a fixed 27-gauge, ½ -inch needle and a needle cover.

### 4 CONTRAINDICATIONS

None.

### 5 WARNINGS AND PRECAUTIONS

#### 5.1 Serious Infections

Patients treated with adalimumab products, including HYRIMOZ, are at increased risk for developing serious infections involving various organ systems and sites that may lead to hospitalization or death [see *Boxed Warning*]. Opportunistic infections due to bacterial, mycobacterial, invasive fungal, viral, parasitic, or other opportunistic pathogens including aspergillosis, blastomycosis, candidiasis, coccidioidomycosis, histoplasmosis, legionellosis, listeriosis, pneumocystosis and tuberculosis have been reported with TNF-blockers. Patients have frequently presented with disseminated rather than localized disease.

The concomitant use of a TNF-blocker and abatacept or anakinra was associated with a higher risk of serious infections in patients with rheumatoid arthritis (RA); therefore, the concomitant use of HYRIMOZ and these biologic products is not recommended in the treatment of patients with RA [see *Warnings and Precautions* ([5.7](#), [5.11](#)) and *Drug Interactions* ([7.2](#))].

Treatment with HYRIMOZ should not be initiated in patients with an active infection, including localized infections. Patients greater than 65 years of age, patients with co-morbid conditions and/or patients taking concomitant immunosuppressants (such as corticosteroids or methotrexate), may be at greater risk of infection. Consider the risks and benefits of treatment prior to initiating therapy in patients:

- with chronic or recurrent infection;
- who have been exposed to tuberculosis;
- with a history of an opportunistic infection;
- who have resided or traveled in areas of endemic tuberculosis or endemic mycoses, such as with histoplasmosis, coccidioidomycosis, or blastomycosis; or
- with underlying conditions that may predispose them to infection.

### *Tuberculosis*

Cases of reactivation of tuberculosis and new onset tuberculosis infections have been reported in patients receiving adalimumab products, including patients who have previously received treatment for latent or active tuberculosis. Reports included cases of pulmonary and extrapulmonary (i.e., disseminated) tuberculosis. Evaluate patients for tuberculosis risk factors and test for latent infection prior to initiating HYRIMOZ and periodically during therapy.

Treatment of latent tuberculosis infection prior to therapy with TNF blocking agents has been shown to reduce the risk of tuberculosis reactivation during therapy. Prior to initiating HYRIMOZ, assess if treatment for latent tuberculosis is needed; and consider an induration of  $\geq 5$  mm a positive tuberculin skin test result, even for patients previously vaccinated with Bacille Calmette-Guerin (BCG).

Consider anti-tuberculosis therapy prior to initiation of HYRIMOZ in patients with a past history of latent or active tuberculosis in whom an adequate course of treatment cannot be confirmed, and for patients with a negative test for latent tuberculosis but having risk factors for tuberculosis infection. Despite prophylactic treatment for tuberculosis, cases of reactivated tuberculosis have occurred in patients treated with adalimumab products. Consultation with a physician with expertise in the treatment of tuberculosis is recommended to aid in the decision whether initiating anti-tuberculosis therapy is appropriate for an individual patient.

Strongly consider tuberculosis in the differential diagnosis in patients who develop a new infection during HYRIMOZ treatment, especially in patients who have previously or recently travelled to countries with a high prevalence of tuberculosis, or who have had close contact with a person with active tuberculosis.

### *Monitoring*

Closely monitor patients for the development of signs and symptoms of infection during and after treatment with HYRIMOZ, including the development of tuberculosis in patients who tested negative for latent tuberculosis infection prior to initiating therapy. Tests for latent tuberculosis infection may also be falsely negative while on therapy with HYRIMOZ.

Discontinue HYRIMOZ if a patient develops a serious infection or sepsis. For a patient who develops a new infection during treatment with HYRIMOZ, closely monitor them, perform a prompt and complete diagnostic workup appropriate for an immunocompromised patient, and initiate appropriate antimicrobial therapy.

### *Invasive Fungal Infections*

If patients develop a serious systemic illness and they reside or travel in regions where mycoses are endemic, consider invasive fungal infection in the differential diagnosis. Antigen and antibody testing for histoplasmosis may be negative in some patients with active infection. Consider appropriate empiric antifungal therapy, taking into account both the risk for severe fungal infection and the risks of antifungal therapy, while a diagnostic workup is being performed. To aid in the management of such patients, consider consultation with a physician with expertise in the diagnosis and treatment of invasive fungal infections.

## 5.2 Malignancies

Consider the risks and benefits of TNF-blocker-treatment including HYRIMOZ prior to initiating therapy in patients with a known malignancy other than a successfully treated non-melanoma skin cancer (NMSC) or when considering continuing a TNF-blocker in patients who develop a malignancy.

### *Malignancies in Adults*

In the controlled portions of clinical trials of some TNF-blockers, including adalimumab products, more cases of malignancies have been observed among TNF-blocker-treated adult patients compared to control-treated adult patients. During the controlled portions of 34 global adalimumab clinical trials in adult patients with rheumatoid arthritis (RA), psoriatic arthritis (PsA), ankylosing spondylitis (AS), Crohn's disease (CD), ulcerative colitis (UC) and plaque psoriasis (Ps), malignancies, other than non melanoma (basal cell and squamous cell) skin cancer, were observed at a rate (95% confidence interval) of 0.6 (0.38, 0.91) per 100 patient years among 7304 adalimumab-treated patients versus a rate of 0.6 (0.30, 1.03) per 100 patient years among 4232 control-treated patients (median duration of treatment of 4 months for adalimumab-treated patients and 4 months for control treated patients). In 47 global controlled and uncontrolled clinical trials of adalimumab in adult patients with RA, PsA, AS, CD, UC, and Ps, the most frequently observed malignancies, other than lymphoma and NMSC, were breast, colon, prostate, lung, and melanoma. The malignancies in adalimumab-treated patients in the controlled and uncontrolled portions of the studies were similar in type and number to what would be expected in the general U.S. population according to the SEER database (adjusted for age, gender, and race).<sup>1</sup>

In controlled trials of other TNF-blockers in adult patients at higher risk for malignancies (i.e., patients with COPD with a significant smoking history and cyclophosphamide-treated patients with Wegener's granulomatosis), a greater portion of malignancies occurred in the TNF-blocker group compared to the control group.

### Non-Melanoma Skin Cancer

During the controlled portions of 34 global adalimumab clinical trials in adult patients with RA, PsA, AS, CD, UC, and Ps, the rate (95% confidence interval) of NMSC was 0.7 (0.49, 1.08) per 100 patient-years among adalimumab-treated patients and 0.2 (0.08, 0.59) per 100 patient-years among control-treated patients. Examine all patients, and in particular patients with a medical history of prior prolonged immunosuppressant therapy or psoriasis patients with a history of PUVA treatment for the presence of NMSC prior to and during treatment with HYRIMOZ.

### Lymphoma and Leukemia

In the controlled portions of clinical trials of all the TNF-blockers in adults, more cases of lymphoma have been observed among TNF-blocker-treated patients compared to control-treated patients. In the controlled portions of 34 global adalimumab clinical trials in adult patients with RA, PsA, AS, CD, UC and Ps, 3 lymphomas occurred among 7304 adalimumab-treated patients versus 1 among 4232 control-treated patients. In 47 global controlled and uncontrolled clinical trials of adalimumab in adult patients with RA, PsA, AS, CD, UC and Ps with a median duration of approximately 0.6 years, including 23,036 patients and over 34,000 patient-years of adalimumab, the observed rate of lymphomas was approximately 0.11 per 100 patient-years. This is approximately 3-fold higher than expected in the general U.S. population according to the SEER database (adjusted for age, gender, and race).<sup>1</sup> Rates of lymphoma in clinical trials of adalimumab cannot be compared to rates of lymphoma in clinical trials of other TNF-blockers and may not predict the rates observed in a broader patient population. Patients with RA and other chronic inflammatory diseases, particularly those with highly active disease and/or chronic exposure to immunosuppressant therapies, may be at a higher risk (up to several fold) than the general population for the development of lymphoma, even in the absence of TNF-blockers. Post-marketing cases of acute and chronic leukemia have been reported in association with TNF-blocker use in RA and other indications. Even in the absence of TNF-blocker therapy, patients with RA may be at a higher risk (approximately 2-fold) than the general population for the development of leukemia.

### *Malignancies in Pediatric Patients and Young Adults*

Malignancies, some fatal, have been reported among children, adolescents, and young adults who received treatment with TNF-blockers (initiation of therapy  $\leq$  18 years of age), of which HYRIMOZ is a member [see *Boxed Warning*]. Approximately half the cases were lymphomas, including Hodgkin's and non-Hodgkin's lymphoma. The other cases represented a variety of different malignancies and included rare malignancies usually associated with immunosuppression and malignancies that are not usually observed in children and adolescents. The malignancies occurred after a median of 30 months of therapy (range 1 to 84 months). Most of the patients were receiving concomitant immunosuppressants. These cases were reported post-marketing and are derived from a variety of sources including registries and spontaneous postmarketing reports.

Postmarketing cases of hepatosplenic T-cell lymphoma (HSTCL), a rare type of T-cell lymphoma, have been reported in patients treated with TNF-blockers including adalimumab products [see *Boxed Warning*]. These cases have had a very aggressive disease course and have been fatal. The majority of reported TNF-blocker cases have occurred in patients with Crohn's disease or ulcerative colitis and the majority were in adolescent and young adult males. Almost all of these patients had received treatment with the immunosuppressants azathioprine or 6-mercaptopurine (6-MP) concomitantly with a TNF-blocker at or prior to diagnosis. It is uncertain whether the occurrence of HSTCL is related to use of a TNF-blocker or a TNF-blocker in combination with these other immunosuppressants. The potential risk with the combination of azathioprine or 6-mercaptopurine and adalimumab products should be carefully considered.

### **5.3 Hypersensitivity Reactions**

Anaphylaxis and angioneurotic edema have been reported following administration of adalimumab products. If an anaphylactic or other serious allergic reaction occurs, immediately discontinue administration of HYRIMOZ and institute appropriate therapy. In clinical trials of adalimumab products in adults, allergic reactions (e.g., allergic rash, anaphylactoid reaction, fixed drug reaction, non-specified drug reaction, urticaria) have been observed.

### **5.4 Hepatitis B Virus Reactivation**

Use of TNF-blockers, including HYRIMOZ, may increase the risk of reactivation of hepatitis B virus (HBV) in patients who are chronic carriers of this virus. In some instances, HBV reactivation occurring in conjunction with TNF-blocker therapy has been fatal. The majority of these reports have occurred in patients concomitantly receiving other medications that suppress the immune system, which may also contribute to HBV reactivation. Evaluate patients at risk for HBV infection for prior evidence of HBV infection before initiating TNF-blocker therapy. Exercise caution in prescribing TNF-blockers for patients identified as carriers of HBV. Adequate data are not available on the safety or efficacy of treating patients who are carriers of HBV with anti-viral therapy in conjunction with TNF-blocker therapy to prevent HBV reactivation. For patients who are carriers of HBV and require treatment with TNF-blockers, closely monitor such patients for clinical and laboratory signs of active HBV infection throughout therapy and for several months following termination of therapy. In patients who develop HBV reactivation, stop HYRIMOZ and initiate effective anti-viral therapy with appropriate supportive treatment. The safety of resuming TNF-blocker therapy after HBV reactivation is controlled is not known. Therefore, exercise caution when considering resumption of HYRIMOZ therapy in this situation and monitor patients closely.

### **5.5 Neurologic Reactions**

Use of TNF-blocking agents, including adalimumab products, has been associated with rare cases of new onset or exacerbation of clinical symptoms and/or radiographic evidence of central nervous system demyelinating disease, including multiple sclerosis (MS) and optic neuritis, and peripheral demyelinating disease, including Guillain-Barré syndrome. Exercise caution in considering the use of HYRIMOZ in patients with pre-existing or recent-onset central or peripheral nervous system demyelinating disorders; discontinuation of HYRIMOZ should be considered if any of these disorders develop.

## 5.6 Hematological Reactions

Rare reports of pancytopenia including aplastic anemia have been reported with TNF-blocking agents. Adverse reactions of the hematologic system, including medically significant cytopenia (e.g., thrombocytopenia, leukopenia) have been infrequently reported with adalimumab products. The causal relationship of these reports to adalimumab products remains unclear. Advise all patients to seek immediate medical attention if they develop signs and symptoms suggestive of blood dyscrasias or infection (e.g., persistent fever, bruising, bleeding, pallor) while on HYRIMOZ. Consider discontinuation of HYRIMOZ therapy in patients with confirmed significant hematologic abnormalities.

## 5.7 Use with Anakinra

Concurrent use of anakinra (an interleukin-1 antagonist) and another TNF-blocker, was associated with a greater proportion of serious infections and neutropenia and no added benefit compared with the TNF-blocker alone in patients with RA. Therefore, the combination of HYRIMOZ and anakinra is not recommended [*see Drug Interactions (7.2)*].

## 5.8 Heart Failure

Cases of worsening congestive heart failure (CHF) and new onset CHF have been reported with TNF-blockers. Cases of worsening CHF have also been observed with adalimumab products. Adalimumab products have not been formally studied in patients with CHF; however, in clinical trials of another TNF-blocker, a higher rate of serious CHF-related adverse reactions was observed. Exercise caution when using HYRIMOZ in patients who have heart failure and monitor them carefully.

## 5.9 Autoimmunity

Treatment with adalimumab products may result in the formation of autoantibodies and, rarely, in the development of a lupus-like syndrome. If a patient develops symptoms suggestive of a lupus-like syndrome following treatment with HYRIMOZ, discontinue treatment [*see Adverse Reactions (6.1)*].

## 5.10 Immunizations

In a placebo-controlled clinical trial of patients with RA, no difference was detected in anti-pneumococcal antibody response between adalimumab and placebo treatment groups when the pneumococcal polysaccharide vaccine and influenza vaccine were administered concurrently with adalimumab. Similar proportions of patients developed protective levels of anti-influenza antibodies between adalimumab and placebo treatment groups; however, titers in aggregate to influenza antigens were moderately lower in patients receiving adalimumab. The clinical significance of this is unknown. Patients on HYRIMOZ may receive concurrent vaccinations, except for live vaccines. No data are available on the secondary transmission of infection by live vaccines in patients receiving adalimumab products.

It is recommended that pediatric patients, if possible, be brought up to date with all immunizations in agreement with current immunization guidelines prior to initiating HYRIMOZ therapy. Patients on HYRIMOZ may receive concurrent vaccinations, except for live vaccines.

The safety of administering live or live-attenuated vaccines in infants exposed to adalimumab products *in utero* is unknown. Risks and benefits should be considered prior to vaccinating (live or live-attenuated) exposed infants [*see Use in Specific Populations (8.1, 8.4)*].

## 5.11 Use with Abatacept

In controlled trials, the concurrent administration of TNF-blockers and abatacept was associated with a greater proportion of serious infections than the use of a TNF-blocker alone; the combination therapy, compared to the use of a TNF-blocker alone, has not demonstrated improved clinical benefit in the treatment of RA. Therefore, the combination of abatacept with TNF-blockers including HYRIMOZ is not recommended [*see Drug Interactions (7.2)*].

## 6 ADVERSE REACTIONS

The most serious adverse reactions described elsewhere in the labeling include the following:

- Serious Infections [*see Warnings and Precautions (5.1)*]
- Malignancies [*see Warnings and Precautions (5.2)*]

### 6.1 Clinical Trials Experience

Because clinical trials are conducted under widely varying conditions, adverse reaction rates observed in the clinical trials of a drug cannot be directly compared to rates in the clinical trials of another drug and may not reflect the rates observed in practice.

The most common adverse reaction with adalimumab was injection site reactions. In placebo-controlled trials, 20% of patients treated with adalimumab developed injection site reactions (erythema and/or itching, hemorrhage, pain or swelling), compared to 14 % of patients receiving placebo. Most injection site reactions were described as mild and generally did not necessitate drug discontinuation.

The proportion of patients who discontinued treatment due to adverse reactions during the double-blind, placebo-controlled portion of studies in patients with RA (i.e., Studies RA-I, RA-II, RA-III and RA-IV) was 7 % for patients taking adalimumab and 4 % for placebo-treated patients. The most common adverse reactions leading to discontinuation of adalimumab in these RA studies were clinical flare reaction (0.7 %), rash (0.3 %) and pneumonia (0.3 %).

#### *Infections*

In the controlled portions of the 34 global adalimumab clinical trials in adult patients with RA, PsA, AS, CD, UC and Ps, the rate of serious infections was 4.6 per 100 patient years in 7304 adalimumab treated patients versus a rate of 3.1 per 100 patient years in 4232 control treated patients. Serious infections observed included pneumonia, septic arthritis, prosthetic and post-surgical infections, erysipelas, cellulitis, diverticulitis, and pyelonephritis [*see Warnings and Precautions (5.1)*].

#### *Tuberculosis and Opportunistic Infections*

In 47 global controlled and uncontrolled clinical trials in RA, PsA, AS, CD, UC and Ps that included 23,036 adalimumab treated patients, the rate of reported active tuberculosis was 0.22 per 100 patient years and the rate of positive PPD conversion was 0.08 per 100 patient years. In a subgroup of 9396 U.S. and Canadian adalimumab treated patients, the rate of reported active TB was 0.07 per 100 patient years and the rate of positive PPD conversion was 0.08 per 100 patient years. These trials included reports of miliary, lymphatic, peritoneal, and pulmonary TB. Most of the TB cases occurred within the first eight months after initiation of therapy and may reflect recrudescence of latent disease. In these global clinical trials, cases of serious opportunistic infections have been reported at an overall rate of 0.05 per 100 patient-years. Some cases of serious opportunistic infections and TB have been fatal [*see Warnings and Precautions (5.1)*].

#### *Autoantibodies*

In the rheumatoid arthritis controlled trials, 12 % of patients treated with adalimumab and 7 % of placebo-treated patients that had negative baseline ANA titers developed positive titers at week 24. Two patients out of 3046 treated with adalimumab developed clinical signs suggestive of new-onset lupus-like syndrome. The patients improved following discontinuation of therapy. No patients developed lupus nephritis or central nervous system symptoms. The impact of long-term treatment with adalimumab products on the development of autoimmune diseases is unknown.

#### *Liver Enzyme Elevations*

There have been reports of severe hepatic reactions including acute liver failure in patients receiving TNF-blockers. In controlled Phase 3 trials of adalimumab (40 mg SC every other week) in patients with RA, PsA, and AS with control period duration ranging from 4 to 104 weeks, ALT elevations  $\geq 3 \times$  ULN occurred in 3.5 %

of adalimumab-treated patients and 1.5 % of control-treated patients. Since many of these patients in these trials were also taking medications that cause liver enzyme elevations (e.g., NSAIDs, MTX), the relationship between adalimumab and the liver enzyme elevations is not clear. In a controlled Phase 3 trial of adalimumab in patients with polyarticular JIA who were 4 to 17 years, ALT elevations  $\geq 3$  x ULN occurred in 4.4 % of adalimumab-treated patients and 1.5 % of control-treated patients (ALT more common than AST); liver enzyme test elevations were more frequent among those treated with the combination of adalimumab and MTX than those treated with adalimumab alone. In general, these elevations did not lead to discontinuation of adalimumab treatment.

In controlled Phase 3 trials of adalimumab (initial doses of 160 mg and 80 mg, or 80 mg and 40 mg on Days 1 and 15, respectively, followed by 40 mg every other week) in adult patients with CD with a control period duration ranging from 4 to 52 weeks, ALT elevations  $\geq 3$  x ULN occurred in 0.9 % of adalimumab-treated patients and 0.9 % of control-treated patients. In controlled Phase 3 trials of adalimumab (initial doses of 160 mg and 80 mg on Days 1 and 15 respectively, followed by 40 mg every other week) in patients with UC with control period duration ranging from 1 to 52 weeks, ALT elevations  $\geq 3$  x ULN occurred in 1.5 % of adalimumab-treated patients and 1.0 % of control-treated patients. In controlled Phase 3 trials of adalimumab (initial dose of 80 mg then 40 mg every other week) in patients with Ps with control period duration ranging from 12 to 24 weeks, ALT elevations  $\geq 3$  x ULN occurred in 1.8 % of adalimumab-treated patients and 1.8 % of control-treated patients.

### *Immunogenicity*

Patients in Studies RA-I, RA-II, and RA-III were tested at multiple time points for antibodies to adalimumab during the 6- to 12-month period. Approximately 5 % (58 of 1062) of adult RA patients receiving adalimumab developed low-titer antibodies to adalimumab at least once during treatment, which were neutralizing in vitro. Patients treated with concomitant methotrexate (MTX) had a lower rate of antibody development than patients on adalimumab monotherapy (1 % versus 12 %). No apparent correlation of antibody development to adverse reactions was observed. With monotherapy, patients receiving every other week dosing may develop antibodies more frequently than those receiving weekly dosing. In patients receiving the recommended dosage of 40 mg every other week as monotherapy, the ACR 20 response was lower among antibody-positive patients than among antibody-negative patients. The long-term immunogenicity of adalimumab is unknown.

In patients with polyarticular JIA who were 4 to 17 years of age, adalimumab antibodies were identified in 16 % of adalimumab-treated patients. In patients receiving concomitant MTX, the incidence was 6 % compared to 26 % with adalimumab monotherapy.

In patients with AS, the rate of development of antibodies to adalimumab in adalimumab-treated patients was comparable to patients with RA.

In patients with PsA, the rate of antibody development in patients receiving adalimumab monotherapy was comparable to patients with RA; however, in patients receiving concomitant MTX the rate was 7 % compared to 1 % in RA.

In adult patients with CD, the rate of antibody development was 3 %.

In patients with moderately to severely active UC, the rate of antibody development in patients receiving adalimumab was 5 %. However, due to the limitation of the assay conditions, antibodies to adalimumab could be detected only when serum adalimumab levels were  $< 2$  mcg/mL. Among the patients whose serum adalimumab levels were  $< 2$  mcg/mL (approximately 25 % of total patients studied), the immunogenicity rate was 20.7 %.

In patients with Ps, the rate of antibody development with adalimumab monotherapy was 8 %. However, due to the limitation of the assay conditions, antibodies to adalimumab could be detected only when serum adalimumab levels were  $< 2$  mcg/mL. Among the patients whose serum adalimumab levels were  $< 2$  mcg/mL (approximately 40 % of total patients studied), the immunogenicity rate was 20.7 %. In Ps patients who were on

adalimumab monotherapy and subsequently withdrawn from the treatment, the rate of antibodies to adalimumab after retreatment was similar to the rate observed prior to withdrawal.

The data reflect the percentage of patients whose test results were considered positive for antibodies to adalimumab or titers, and are highly dependent on the assay. The observed incidence of antibody (including neutralizing antibody) positivity in an assay is highly dependent on several factors including assay sensitivity and specificity, assay methodology, sample handling, timing of sample collection, concomitant medications, and underlying disease. For these reasons, comparison of the incidence of antibodies to adalimumab reported in this section with the incidence of antibodies in other studies or to other products may be misleading.

*Other Adverse Reactions*

**Rheumatoid Arthritis Clinical Studies**

The data described below reflect exposure to adalimumab in 2468 patients, including 2073 exposed for 6 months, 1497 exposed for greater than one year and 1380 in adequate and well-controlled studies (Studies RA-I, RA-II, RA-III, and RA-IV). Adalimumab was studied primarily in placebo-controlled trials and in long-term follow up studies for up to 36 months duration. The population had a mean age of 54 years, 77 % were female, 91 % were Caucasian and had moderately to severely active rheumatoid arthritis. Most patients received 40 mg adalimumab every other week.

Table 1 summarizes reactions reported at a rate of at least 5 % in patients treated with adalimumab 40 mg every other week compared to placebo and with an incidence higher than placebo. In Study RA-III, the types and frequencies of adverse reactions in the second year open-label extension were similar to those observed in the one-year double-blind portion.

**Table 1. Adverse Reactions Reported by  $\geq 5\%$  of Patients Treated with Adalimumab During Placebo-Controlled Period of Pooled RA Studies (Studies RA-I, RA-II, RA-III, and RA-IV)**

	<b>Adalimumab 40 mg subcutaneous Every Other Week</b>	<b>Placebo</b>
	<b>(N=705)</b>	<b>(N=690)</b>
Adverse Reaction (Preferred Term)		
<b>Respiratory</b>		
Upper respiratory infection	17 %	13 %
Sinusitis	11 %	9 %
Flu syndrome	7 %	6 %
<b>Gastrointestinal</b>		
Nausea	9 %	8 %
Abdominal pain	7 %	4 %
<b>Laboratory Tests*</b>		
Laboratory test abnormal	8 %	7 %
Hypercholesterolemia	6 %	4 %
Hyperlipidemia	7 %	5 %
Hematuria	5 %	4 %
Alkaline phosphatase increased	5 %	3 %
<b>Other</b>		
Headache	12 %	8 %
Rash	12 %	6 %

Accidental injury	10 %	8 %
Injection site reaction **	8 %	1 %
Back pain	6 %	4 %
Urinary tract infection	8 %	5 %
Hypertension	5 %	3 %
* Laboratory test abnormalities were reported as adverse reactions in European trials		
** Does not include injection site erythema, itching, hemorrhage, pain or swelling		

### Less Common Adverse Reactions in Rheumatoid Arthritis Clinical Studies

Other infrequent serious adverse reactions that do not appear in the Warnings and Precautions or Adverse Reaction sections that occurred at an incidence of less than 5 % in adalimumab-treated patients in RA studies were:

*Body As A Whole:* Pain in extremity, pelvic pain, surgery, thorax pain

*Cardiovascular System:* Arrhythmia, atrial fibrillation, chest pain, coronary artery disorder, heart arrest, hypertensive encephalopathy, myocardial infarct, palpitation, pericardial effusion, pericarditis, syncope, tachycardia

*Digestive System:* Cholecystitis, cholelithiasis, esophagitis, gastroenteritis, gastrointestinal hemorrhage, hepatic necrosis, vomiting

*Endocrine System:* Parathyroid disorder

*Hemic And Lymphatic System:* Agranulocytosis, polycythemia

*Metabolic And Nutritional Disorders:* Dehydration, healing abnormal, ketosis, paraproteinemia, peripheral edema

*Musculo-Skeletal System:* Arthritis, bone disorder, bone fracture (not spontaneous), bone necrosis, joint disorder, muscle cramps, myasthenia, pyogenic arthritis, synovitis, tendon disorder

*Neoplasia:* Adenoma

*Nervous System:* Confusion, paresthesia, subdural hematoma, tremor

*Respiratory System:* Asthma, bronchospasm, dyspnea, lung function decreased, pleural effusion

*Special Senses:* Cataract

*Thrombosis:* Thrombosis leg

*Urogenital System:* Cystitis, kidney calculus, menstrual disorder

### Juvenile Idiopathic Arthritis Clinical Studies

In general, the adverse reactions in the adalimumab-treated patients in the polyarticular juvenile idiopathic arthritis (JIA) trials (Study JIA-I) were similar in frequency and type to those seen in adult patients [see *Warnings and Precautions* ([5](#)), *Adverse Reactions* ([6](#))]. Important findings and differences from adults are discussed in the following paragraphs.

In Study JIA-I, adalimumab was studied in 171 patients who were 4 to 17 years of age, with polyarticular JIA. Severe adverse reactions reported in the study included neutropenia, streptococcal pharyngitis, increased aminotransferases, herpes zoster, myositis, metrorrhagia, and appendicitis. Serious infections were observed in 4 % of patients within approximately 2 years of initiation of treatment with adalimumab and included cases of herpes simplex, pneumonia, urinary tract infection, pharyngitis, and herpes zoster.

In Study JIA-I, 45 % of patients experienced an infection while receiving adalimumab with or without concomitant MTX in the first 16 weeks of treatment. The types of infections reported in adalimumab-treated patients were generally similar to those commonly seen in polyarticular JIA patients who are not treated with TNF-blockers. Upon initiation of treatment, the most common adverse reactions occurring in this patient population treated with adalimumab were injection site pain and injection site reaction (19 % and 16 %,

respectively). A less commonly reported adverse event in patients receiving adalimumab was granuloma annulare which did not lead to discontinuation of adalimumab-treatment.

In the first 48 weeks of treatment in Study JIA-I, non-serious hypersensitivity reactions were seen in approximately 6 % of patients and included primarily localized allergic hypersensitivity reactions and allergic rash.

In Study JIA-I, 10% of patients treated with adalimumab who had negative baseline anti-dsDNA antibodies developed positive titers after 48 weeks of treatment. No patient developed clinical signs of autoimmunity during the clinical trial.

Approximately 15 % of patients treated with adalimumab developed mild-to-moderate elevations of creatine phosphokinase (CPK) in Study JIA-I. Elevations exceeding 5 times the upper limit of normal were observed in several patients. CPK levels decreased or returned to normal in all patients. Most patients were able to continue adalimumab without interruption.

#### Psoriatic Arthritis and Ankylosing Spondylitis Clinical Studies

Adalimumab has been studied in 395 patients with psoriatic arthritis (PsA) in two placebo-controlled trials and in an open label study and in 393 patients with ankylosing spondylitis (AS) in two placebo-controlled studies. The safety profile for patients with PsA and AS treated with adalimumab 40 mg every other week was similar to the safety profile seen in patients with RA, adalimumab Studies RA-I through IV.

#### Adult Crohn's Disease Clinical Studies

Adalimumab has been studied in 1478 adult patients with Crohn's disease (CD) in four placebo-controlled and two open-label extension studies. The safety profile for adult patients with CD treated with adalimumab was similar to the safety profile seen in patients with RA.

#### Ulcerative Colitis Clinical Studies

Adalimumab has been studied in 1010 patients with ulcerative colitis (UC) in two placebo-controlled studies and one open-label extension study. The safety profile for patients with UC treated with adalimumab was similar to the safety profile seen in patients with RA.

#### Plaque Psoriasis Clinical Studies

Adalimumab has been studied in 1696 subjects with plaque psoriasis (Ps) in placebo-controlled and open-label extension studies. The safety profile for subjects with Ps treated with adalimumab was similar to the safety profile seen in subjects with RA with the following exceptions. In the placebo-controlled portions of the clinical trials in Ps subjects, adalimumab-treated subjects had a higher incidence of arthralgia when compared to controls (3 % vs. 1 %).

## **6.2 Postmarketing Experience**

The following adverse reactions have been identified during post-approval use of adalimumab products. Because these reactions are reported voluntarily from a population of uncertain size, it is not always possible to reliably estimate their frequency or establish a causal relationship to adalimumab products exposure.

*Gastrointestinal disorders:* Diverticulitis, large bowel perforations including perforations associated with diverticulitis and appendiceal perforations associated with appendicitis, pancreatitis

*General disorders and administration site conditions:* Pyrexia

*Hepato-biliary disorders:* Liver failure, hepatitis

*Immune system disorders:* Sarcoidosis

*Neoplasms benign, malignant and unspecified (including cysts and polyps):* Merkel Cell Carcinoma (neuroendocrine carcinoma of the skin)

*Nervous system disorders:* Demyelinating disorders (e.g., optic neuritis, Guillain-Barré syndrome), cerebrovascular accident

*Respiratory disorders:* Interstitial lung disease, including pulmonary fibrosis, pulmonary embolism

*Skin reactions:* Stevens Johnson Syndrome, cutaneous vasculitis, erythema multiforme, new or worsening psoriasis (all sub-types including pustular and palmoplantar), alopecia, lichenoid skin reaction

*Vascular disorders:* Systemic vasculitis, deep vein thrombosis

## **7 DRUG INTERACTIONS**

### **7.1 Methotrexate**

Adalimumab products have been studied in rheumatoid arthritis (RA) patients taking concomitant methotrexate (MTX). Although MTX reduced the apparent clearance of adalimumab products, the data do not suggest the need for dose adjustment of either HYRIMOZ or MTX [*see Clinical Pharmacology (12.3)*].

### **7.2 Biological Products**

In clinical studies in patients with RA, an increased risk of serious infections has been seen with the combination of TNF-blockers with anakinra or abatacept, with no added benefit; therefore, use of HYRIMOZ with abatacept or anakinra is not recommended in patients with RA [*see Warnings and Precautions (5.7 and 5.11)*]. A higher rate of serious infections has also been observed in patients with RA treated with rituximab who received subsequent treatment with a TNF-blocker. There is insufficient information regarding the concomitant use of HYRIMOZ and other biologic products for the treatment of RA, PsA, AS, CD, UC and Ps. Concomitant administration of HYRIMOZ with other biologic DMARDS (e.g., anakinra and abatacept) or other TNF-blockers is not recommended based upon the possible increased risk for infections and other potential pharmacological interactions.

### **7.3 Live Vaccines**

Avoid the use of live vaccines with HYRIMOZ [*see Warnings and Precautions (5.10)*].

### **7.4 Cytochrome P450 Substrates**

The formation of CYP450 enzymes may be suppressed by increased levels of cytokines (e.g., TNF $\alpha$ , IL-6) during chronic inflammation. It is possible for products that antagonize cytokine activity, such as adalimumab products, to influence the formation of CYP450 enzymes. Upon initiation or discontinuation of HYRIMOZ in patients being treated with CYP450 substrates with a narrow therapeutic index, monitoring of the effect (e.g., warfarin) or drug concentration (e.g., cyclosporine or theophylline) is recommended and the individual dose of the drug product may be adjusted as needed.

## **8 USE IN SPECIFIC POPULATIONS**

### **8.1 Pregnancy**

#### Risk Summary

Available studies with use of adalimumab during pregnancy do not reliably establish an association between adalimumab and major birth defects. Clinical data are available from the Organization of Teratology Information Specialists (OTIS)/MotherToBaby Pregnancy Registry in pregnant women with rheumatoid arthritis (RA) or Crohn's disease (CD) treated with adalimumab. Registry results showed a rate of 10% for major birth defects with first trimester use of adalimumab in pregnant women with RA or CD and a rate of 7.5% for major birth defects in the disease-matched comparison cohort. The lack of pattern of major birth

defects is reassuring and differences between exposure groups may have impacted the occurrence of birth defects (*see Data*).

Adalimumab is actively transferred across the placenta during the third trimester of pregnancy and may affect immune response in the *in-utero* exposed infant (*see Clinical Considerations*). In an embryo-fetal perinatal development study conducted in cynomolgus monkeys, no fetal harm or malformations were observed with intravenous administration of adalimumab during organogenesis and later in gestation, at doses that produced exposures up to approximately 373 times the maximum recommended human dose (MRHD) of 40 mg subcutaneous without methotrexate (*see Data*).

The estimated background risk of major birth defects and miscarriage for the indicated populations is unknown. All pregnancies have a background risk of birth defect, loss, or other adverse outcomes. In the U.S. general population, the estimated background risk of major birth defects and miscarriage in clinically recognized pregnancies is 2–4% and 15–20%, respectively.

## Clinical Considerations

### *Disease-associated maternal and embryo/fetal risk*

Published data suggest that the risk of adverse pregnancy outcomes in women with RA or inflammatory bowel disease (IBD) is associated with increased disease activity. Adverse pregnancy outcomes include preterm delivery (before 37 weeks of gestation), low birth weight (less than 2500 g) infants, and small for gestational age at birth.

### *Fetal/Neonatal Adverse Reactions*

Monoclonal antibodies are increasingly transported across the placenta as pregnancy progresses, with the largest amount transferred during the third trimester (*see Data*). Risks and benefits should be considered prior to administering live or live-attenuated vaccines to infants exposed to adalimumab products *in utero* [*see Use in Specific Populations (8.4)*].

## Data

### *Human Data*

A prospective cohort pregnancy exposure registry conducted by OTIS/MotherToBaby in the U.S. and Canada between 2004 and 2016 compared the risk of major birth defects in live-born infants of 221 women (69 RA, 152 CD) treated with adalimumab during the first trimester and 106 women (74 RA, 32 CD) not treated with adalimumab.

The proportion of major birth defects among live-born infants in the adalimumab-treated and untreated cohorts was 10% (8.7% RA, 10.5% CD) and 7.5% (6.8% RA, 9.4% CD), respectively. The lack of pattern of major birth defects is reassuring and differences between exposure groups may have impacted the occurrence of birth defects. This study cannot reliably establish whether there is an association between adalimumab and major birth defects because of methodological limitations of the registry, including small sample size, the voluntary nature of the study, and the non-randomized design.

In an independent clinical study conducted in ten pregnant women with IBD treated with adalimumab, adalimumab concentrations were measured in maternal serum as well as in cord blood (n=10) and infant serum (n=8) on the day of birth. The last dose of adalimumab was given between 1 and 56 days prior to delivery. Adalimumab concentrations were 0.16 to 19.7 mcg/mL in cord blood, 4.28 to 17.7 mcg/mL in infant serum, and 0 to 16.1 mcg/mL in maternal serum. In all but one case, the cord blood level of adalimumab was higher than the maternal serum level, suggesting adalimumab actively crosses the placenta. In addition, one infant had serum levels at each of the following: 6 weeks (1.94 mcg/mL), 7 weeks (1.31 mcg/mL), 8 weeks (0.93 mcg/mL), and 11 weeks (0.53 mcg/mL), suggesting adalimumab can be detected in the serum of infants exposed in utero for at least 3 months from birth.

### *Animal Data*

In an embryo-fetal perinatal development study, pregnant cynomolgus monkeys received adalimumab from gestation days 20 to 97 at doses that produced exposures up to 373 times that achieved with the MRHD without methotrexate (on an AUC basis with maternal IV doses up to 100 mg/kg/week). Adalimumab did not elicit harm to the fetuses or malformations.

## 8.2 Lactation

### Risk Summary

Limited data from case reports in the published literature describe the presence of adalimumab in human milk at infant doses of 0.1 % to 1 % of the maternal serum level. Published data suggest that the systemic exposure to a breastfed infant is expected to be low because adalimumab is a large molecule and is degraded in the gastrointestinal tract. However, the effects of local exposure in the gastrointestinal tract are unknown. There are no reports of adverse effects of adalimumab products on the breastfed infant and no effects on milk production. The developmental and health benefits of breastfeeding should be considered along with the mother's clinical need for HYRIMOZ and any potential adverse effects on the breastfed child from HYRIMOZ or from the underlying maternal condition.

## 8.4 Pediatric Use

Safety and efficacy of HYRIMOZ in pediatric patients for uses other than polyarticular juvenile idiopathic arthritis (JIA) have not been established. Due to its inhibition of TNF $\alpha$ , adalimumab products administered during pregnancy could affect immune response in the in utero-exposed newborn and infant. Data from eight infants exposed to adalimumab in utero suggest adalimumab crosses the placenta [see *Use in Specific Populations* (8.1)]. The clinical significance of elevated adalimumab levels in infants is unknown. The safety of administering live or live-attenuated vaccines in exposed infants is unknown. Risks and benefits should be considered prior to vaccinating (live or live-attenuated) exposed infants.

Post-marketing cases of lymphoma, including hepatosplenic T-cell lymphoma and other malignancies, some fatal, have been reported among children, adolescents, and young adults who received treatment with TNF-blockers including adalimumab products [see [Boxed Warning and Warnings and Precautions](#) (5.2)].

### *Juvenile Idiopathic Arthritis*

In Study JIA-I, adalimumab was shown to reduce signs and symptoms of active polyarticular JIA in patients 4 to 17 years of age [see *Clinical Studies* (14.2)]. Adalimumab products have not been studied in patients with polyarticular JIA less than 2 years of age or in patients with a weight below 10 kg.

The safety of adalimumab in patients in the polyarticular JIA trials was generally similar to that observed in adults with certain exceptions [see *Adverse Reactions* (6.1)].

## 8.5 Geriatric Use

A total of 519 RA patients 65 years of age and older, including 107 patients 75 years of age and older, received adalimumab in clinical studies RA-I through IV. No overall difference in effectiveness was observed between these patients and younger patients. The frequency of serious infection and malignancy among adalimumab treated patients over 65 years of age was higher than for those under 65 years of age. Because there is a higher incidence of infections and malignancies in the elderly population, use caution when treating the elderly.

## 10 OVERDOSAGE

Doses up to 10 mg/kg have been administered to patients in clinical trials without evidence of dose-limiting toxicities. In case of overdose, it is recommended that the patient be monitored for any signs or symptoms of adverse reactions or effects and appropriate symptomatic treatment instituted immediately.

## 11 DESCRIPTION

HYRIMOZ (adalimumab-adaz) is a recombinant human IgG1 monoclonal antibody specific for human tumor necrosis factor (TNF). HYRIMOZ is an antibody with human derived heavy and light chain variable regions and human IgG1:k constant regions. Adalimumab-adaz is produced by recombinant DNA technology in a Chinese

hamster ovary cell expression system and is purified by a process that includes specific viral inactivation and removal steps. It consists of 1330 amino acids and has a molecular weight of approximately 148 kilodaltons.

HYRIMOZ is supplied as a sterile, preservative-free solution of adalimumab-adaz for subcutaneous administration. The drug product is supplied as either a single-dose, pre-filled pen (Sensoready® Pen) or as a single-dose, pre-filled 1 mL glass syringe with needle guard and add-on finger flange. Enclosed within the Pen is a single-dose, 1 mL pre-filled glass syringe. The solution of HYRIMOZ is clear, colorless to slightly yellowish, with a pH of about 5.2.

Each 40 mg/0.8 mL HYRIMOZ single-dose pre-filled Sensoready® Pen or HYRIMOZ single-dose pre-filled syringe delivers 0.8 mL (40 mg) of drug product. Each 0.8 mL of HYRIMOZ contains adalimumab-adaz 40 mg, adipic acid (2.69 mg), citric acid monohydrate (0.206 mg), mannitol (9.6 mg), polysorbate 80 (0.8 mg), sodium chloride (4.93 mg), and Water for Injection, USP. Hydrochloric acid and sodium hydroxide are added as necessary to adjust pH.

## 12 CLINICAL PHARMACOLOGY

### 12.1 Mechanism of Action

Adalimumab products bind specifically to TNF-alpha and block its interaction with the p55 and p75 cell surface TNF receptors. Adalimumab products also lyse surface TNF expressing cells in vitro in the presence of complement. Adalimumab products do not bind or inactivate lymphotoxin (TNF-beta). TNF is a naturally occurring cytokine that is involved in normal inflammatory and immune responses. Elevated levels of TNF are found in the synovial fluid of patients with RA, JIA, PsA, and AS and play an important role in both the pathologic inflammation and the joint destruction that are hallmarks of these diseases. Increased levels of TNF are also found in psoriasis plaques. In Ps, treatment with HYRIMOZ may reduce the epidermal thickness and infiltration of inflammatory cells. The relationship between these pharmacodynamic activities and the mechanism(s) by which adalimumab products exert their clinical effects is unknown.

Adalimumab products also modulate biological responses that are induced or regulated by TNF, including changes in the levels of adhesion molecules responsible for leukocyte migration (ELAM-1, VCAM-1, and ICAM-1 with an IC<sub>50</sub> of 1-2 X 10<sup>-10</sup>M).

### 12.2 Pharmacodynamics

After treatment with adalimumab, a decrease in levels of acute phase reactants of inflammation (C-reactive protein [CRP] and erythrocyte sedimentation rate [ESR]) and serum cytokines (IL-6) was observed compared to baseline in patients with rheumatoid arthritis. A decrease in CRP levels was also observed in patients with Crohn's disease and ulcerative colitis. Serum levels of matrix metalloproteinases (MMP-1 and MMP-3) that produce tissue remodeling responsible for cartilage destruction were also decreased after adalimumab administration.

### 12.3 Pharmacokinetics

The maximum serum concentration (C<sub>max</sub>) and the time to reach the maximum concentration (T<sub>max</sub>) were 4.7 ± 1.6 mcg/mL and 131 ± 56 hours respectively, following a single 40 mg subcutaneous administration of adalimumab to healthy adult subjects. The average absolute bioavailability of adalimumab estimated from three studies following a single 40 mg subcutaneous dose was 64 %. The pharmacokinetics of adalimumab were linear over the dose range of 0.5 to 10.0 mg/kg following a single intravenous dose.

The single dose pharmacokinetics of adalimumab in RA patients were determined in several studies with intravenous doses ranging from 0.25 to 10 mg/kg. The distribution volume (V<sub>ss</sub>) ranged from 4.7 to 6.0 L. The systemic clearance of adalimumab is approximately 12 mL/hr. The mean terminal half-life was approximately 2 weeks, ranging from 10 to 20 days across studies. Adalimumab concentrations in the synovial fluid from five rheumatoid arthritis patients ranged from 31 to 96 % of those in serum.

In RA patients receiving 40 mg adalimumab every other week, adalimumab mean steady-state trough concentrations of approximately 5 mcg/mL and 8 to 9 mcg/mL, were observed without and with methotrexate (MTX), respectively. MTX reduced adalimumab apparent clearance after single and multiple dosing by 29 % and 44 %, respectively, in patients with RA. Mean serum adalimumab trough levels at steady state increased approximately proportionally with dose following 20, 40, and 80 mg every other week and every week

subcutaneous dosing. In long-term studies with dosing more than two years, there was no evidence of changes in clearance over time.

Adalimumab mean steady-state trough concentrations were slightly higher in psoriatic arthritis patients treated with 40 mg adalimumab every other week (6 to 10 mcg/mL and 8.5 to 12 mcg/mL, without and with MTX, respectively) compared to the concentrations in RA patients treated with the same dose.

The pharmacokinetics of adalimumab in patients with AS were similar to those in patients with RA.

In patients with CD, the loading dose of 160 mg adalimumab on Week 0 followed by 80 mg adalimumab on Week 2 achieves mean serum adalimumab trough levels of approximately 12 mcg/mL at Week 2 and Week 4. Mean steady-state trough levels of approximately 7 mcg/mL were observed at Week 24 and Week 56 in CD patients after receiving a maintenance dose of 40 mg adalimumab every other week.

In patients with UC, the loading dose of 160 mg adalimumab on Week 0 followed by 80 mg adalimumab on Week 2 achieves mean serum adalimumab trough levels of approximately 12 mcg/mL at Week 2 and Week 4. Mean steady-state trough level of approximately 8 mcg/mL was observed at Week 52 in UC patients after receiving a dose of 40 mg adalimumab every other week, and approximately 15 mcg/mL at Week 52 in UC patients who increased to a dose of 40 mg adalimumab every week.

In patients with Ps, the mean steady-state trough concentration was approximately 5 to 6 mcg/mL during adalimumab 40 mg every other week monotherapy treatment.

Population pharmacokinetic analyses in patients with RA revealed that there was a trend toward higher apparent clearance of adalimumab in the presence of anti-adalimumab antibodies, and lower clearance with increasing age in patients aged 40 to >75 years.

Minor increases in apparent clearance were also predicted in RA patients receiving doses lower than the recommended dose and in RA patients with high rheumatoid factor or CRP concentrations. These increases are not likely to be clinically important.

No gender-related pharmacokinetic differences were observed after correction for a patient's body weight. Healthy volunteers and patients with rheumatoid arthritis displayed similar adalimumab pharmacokinetics.

No pharmacokinetic data are available in patients with hepatic or renal impairment.

In Study JIA-I for patients with polyarticular JIA the mean steady-state trough serum adalimumab concentrations for patients weighing  $\geq 30$  kg receiving 40 mg adalimumab subcutaneously every other week as monotherapy or with concomitant MTX were 6.6 mcg/mL and 8.1 mcg/mL, respectively.

## 13 NONCLINICAL TOXICOLOGY

### 13.1 Carcinogenesis, Mutagenesis, Impairment of Fertility

Long-term animal studies of adalimumab products have not been conducted to evaluate the carcinogenic potential or its effect on fertility.

## 14 CLINICAL STUDIES

### 14.1 Rheumatoid Arthritis

The efficacy and safety of adalimumab were assessed in five randomized, double-blind studies in patients  $\geq 18$  years of age with active rheumatoid arthritis (RA) diagnosed according to American College of Rheumatology (ACR) criteria. Patients had at least 6 swollen and 9 tender joints. Adalimumab was administered subcutaneously in combination with methotrexate (MTX) (12.5 to 25 mg, Studies RA-I, RA-III and RA-V) or as monotherapy (Studies RA-II and RA-V) or with other disease-modifying anti-rheumatic drugs (DMARDs) (Study RA-IV).

Study RA-I evaluated 271 patients who had failed therapy with at least one but no more than four DMARDs and had inadequate response to MTX. Doses of 20, 40 or 80 mg of adalimumab or placebo were given every other week for 24 weeks.

Study RA-II evaluated 544 patients who had failed therapy with at least one DMARD. Doses of placebo, 20 or 40 mg of adalimumab were given as monotherapy every other week or weekly for 26 weeks.

Study RA-III evaluated 619 patients who had an inadequate response to MTX. Patients received placebo, 40 mg of adalimumab every other week with placebo injections on alternate weeks, or 20 mg of adalimumab weekly for

up to 52 weeks. Study RA-III had an additional primary endpoint at 52 weeks of inhibition of disease progression (as detected by X-ray results). Upon completion of the first 52 weeks, 457 patients enrolled in an open-label extension phase in which 40 mg of adalimumab was administered every other week for up to 5 years.

Study RA-IV assessed safety in 636 patients who were either DMARD-naïve or were permitted to remain on their pre-existing rheumatologic therapy provided that therapy was stable for a minimum of 28 days. Patients were randomized to 40 mg of adalimumab or placebo every other week for 24 weeks.

Study RA-V evaluated 799 patients with moderately to severely active RA of less than 3 years duration who were ≥18 years old and MTX naïve. Patients were randomized to receive either MTX (optimized to 20 mg/week by week 8), adalimumab 40 mg every other week or adalimumab/MTX combination therapy for 104 weeks. Patients were evaluated for signs and symptoms, and for radiographic progression of joint damage. The median disease duration among patients enrolled in the study was 5 months. The median MTX dose achieved was 20 mg.

*Clinical Response*

The percent of adalimumab treated patients achieving ACR 20, 50 and 70 responses in Studies RA-II and III are shown in Table 2.

**Table 2. ACR Responses in Studies RA-II and RA-III (Percent of Patients)**

Response	Study RA-II Monotherapy (26 weeks)			Study RA-III Methotrexate Combination (24 and 52 weeks)	
	Placebo	Adalimumab 40 mg every other week	Adalimumab 40 mg weekly	Placebo/MTX	Adalimumab/MTX
	N=110	N=113	N=103	N=200	N=207
<b>ACR20</b>					
Month 6	19 %	46 %*	53 %*	30 %	63 %*
Month 12	NA	NA	NA	24 %	59 %*
<b>ACR50</b>					
Month 6	8 %	22 %*	35 %*	10 %	39 %*
Month 12	NA	NA	NA	10 %	42 %*
<b>ACR70</b>					
Month 6	2 %	12 %*	18 %*	3 %	21 %*
Month 12	NA	NA	NA	5 %	23 %*

\* p<0.01, a dalimumab vs. placebo

The results of Study RA-I were similar to Study RA-III; patients receiving adalimumab 40 mg every other week in Study RA-I also achieved ACR 20, 50 and 70 response rates of 65 %, 52 % and 24 %, respectively, compared to placebo responses of 13 %, 7 % and 3 % respectively, at 6 months (p<0.01).

The results of the components of the ACR response criteria for Studies RA-II and RA-III are shown in [Table 3](#). ACR response rates and improvement in all components of ACR response were maintained to week 104. Over the 2 years in Study RA-III, 20 % of adalimumab patients receiving 40 mg every other week (EOW) achieved a major clinical response, defined as maintenance of an ACR 70 response over a 6-month period. ACR responses were maintained in similar proportions of patients for up to 5 years with continuous adalimumab treatment in the open-label portion of Study RA-III.

**Table 3. Components of ACR Response in Studies RA-II and RA-III**

Parameter (median)	Study RA-II				Study RA-III			
	Placebo N=110		Adalimumab <sup>a</sup> N=113		Placebo/MTX N=200		Adalimumab <sup>a</sup> /MTX N=207	
	Baseline	Wk 26	Baseline	Wk 26	Baseline	Wk 24	Baseline	Wk 24
Number of tender joints (0-68)	35	26	31	16*	26	15	24	8*
Number of swollen joints (0-66)	19	16	18	10*	17	11	18	5*
Physician global assessment <sup>b</sup>	7.0	6.1	6.6	3.7*	6.3	3.5	6.5	2.0*
Patient global assessment <sup>b</sup>	7.5	6.3	7.5	4.5*	5.4	3.9	5.2	2.0*
Pain <sup>b</sup>	7.3	6.1	7.3	4.1*	6.0	3.8	5.8	2.1*
Disability index (HAQ) <sup>c</sup>	2.0	1.9	1.9	1.5*	1.5	1.3	1.5	0.8*
CRP (mg/dL)	3.9	4.3	4.6	1.8*	1.0	0.9	1.0	0.4*

<sup>a</sup> 40 mg adalimumab administered every other week  
<sup>b</sup> Visual analogue scale; 0 = best, 10 = worst  
<sup>c</sup> Disability Index of the Health Assessment Questionnaire; 0 = best, 3 = worst, measures the patient's ability to perform the following: dress/groom, arise, eat, walk, reach, grip, maintain hygiene, and maintain daily activity  
\* p<0.001, a dalimumab vs. placebo, based on mean change from baseline

The time course of ACR 20 response for Study RA-III is shown in Figure 1.

In Study RA-III, 85 % of patients with ACR 20 responses at week 24 maintained the response at 52 weeks. The time course of ACR 20 response for Study RA-I and Study RA-II were similar.

**Figure 1. Study RA-III ACR 20 Responses over 52 Weeks**

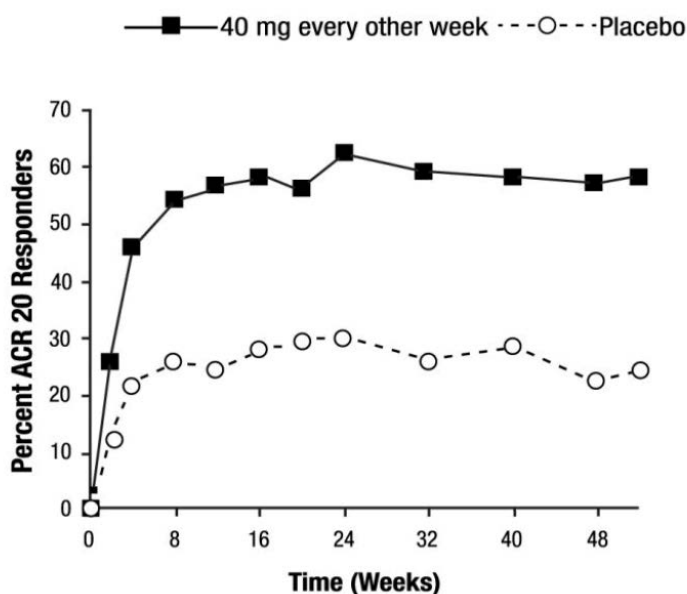

In Study RA-IV, 53 % of patients treated with adalimumab 40 mg every other week plus standard of care had an ACR 20 response at week 24 compared to 35 % on placebo plus standard of care (p<0.001). No unique adverse reactions related to the combination of adalimumab and other DMARDs were observed.

In Study RA-V with MTX naïve patients with recent onset RA, the combination treatment with adalimumab plus MTX led to greater percentages of patients achieving ACR responses than either MTX monotherapy or adalimumab monotherapy at Week 52 and responses were sustained at Week 104 (see Table 4).

**Table 4. ACR Response in Study RA-V (Percent of Patients)**

Response	MTX <sup>b</sup> N=257	Adalimumab <sup>c</sup> N=274	Adalimumab/MTX N=268
<b>ACR 20</b>			
Week 52	63 %	54 %	73 %
Week 104	56 %	49 %	69 %
<b>ACR 50</b>			
Week 52	46 %	41 %	62 %
Week 104	43 %	37 %	59 %
<b>ACR 70</b>			
Week 52	27 %	26 %	46 %
Week 104	28 %	28 %	47 %
Major Clinical Response <sup>a</sup>	28 %	25 %	49 %

<sup>a</sup> Major clinical response is defined as achieving an ACR 70 response for a continuous six month period  
<sup>b</sup> p<0.05, a dalimumab/MTX vs. MTX for ACR 20  
<sup>c</sup> p<0.001, a dalimumab/MTX vs. MTX for ACR 50 and 70, and Major Clinical Response  
<sup>c</sup> p<0.001, a dalimumab/MTX vs. a dalimumab

At Week 52, all individual components of the ACR response criteria for Study RA-V improved in the adalimumab/MTX group and improvements were maintained to Week 104.

### Radiographic Response

In Study RA-III, structural joint damage was assessed radiographically and expressed as change in Total Sharp Score (TSS) and its components, the erosion score and Joint Space Narrowing (JSN) score, at month 12 compared to baseline. At baseline, the median TSS was approximately 55 in the placebo and 40 mg every other week groups. The results are shown in Table 5. Adalimumab/MTX treated patients demonstrated less radiographic progression than patients receiving MTX alone at 52 weeks.

**Table 5. Radiographic Mean Changes Over 12 Months in Study RA-III**

	Placebo/MTX	Adalimumab/MTX X 40 mg every other week	Placebo/MTX- Adalimumab/MTX (95 % Confidence Interval*)	P-value**
Total Sharp score	2.7	0.1	2.6 (1.4, 3.8)	<0.001
Erosion score	1.6	0.0	1.6 (0.9, 2.2)	<0.001
JSN score	1.0	0.1	0.9 (0.3, 1.4)	0.002

\* 95 % confidence intervals for the differences in change scores between MTX and a dalimumab.  
\*\* Based on rank analysis

In the open-label extension of Study RA-III, 77 % of the original patients treated with any dose of adalimumab were evaluated radiographically at 2 years. Patients maintained inhibition of structural damage, as measured by the TSS. Fifty-four percent had no progression of structural damage as defined by a change in the TSS of zero

or less. Fifty-five percent (55 %) of patients originally treated with 40 mg adalimumab every other week have been evaluated radiographically at 5 years. Patients had continued inhibition of structural damage with 50 % showing no progression of structural damage defined by a change in the TSS of zero or less.

In Study RA-V, structural joint damage was assessed as in Study RA-III. Greater inhibition of radiographic progression, as assessed by changes in TSS, erosion score and JSN was observed in the adalimumab/MTX combination group as compared to either the MTX or adalimumab monotherapy group at Week 52 as well as at Week 104 (see Table 6).

**Table 6. Radiographic Mean Change\* in Study RA-V**

		<b>MTX<sup>a</sup></b> <b>N=257</b>	<b>Adalimumab<sup>a,b</sup></b> <b>N=274</b>	<b>Adalimumab/MTX</b> <b>N=268</b>
52 Weeks	Total Sharp score	5.7 (4.2, 7.3)	3.0 (1.7, 4.3)	1.3 (0.5, 2.1)
	Erosion score	3.7 (2.7, 4.8)	1.7 (1.0, 2.4)	0.8 (0.4, 1.2)
	JSN score	2.0 (1.2, 2.8)	1.3 (0.5, 2.1)	0.5 (0.0, 1.0)
104 Weeks	Total Sharp score	10.4 (7.7, 13.2)	5.5 (3.6, 7.4)	1.9 (0.9, 2.9)
	Erosion score	6.4 (4.6, 8.2)	3.0 (2.0, 4.0)	1.0 (0.4, 1.6)
	JSN score	4.1 (2.7, 5.4)	2.6 (1.5, 3.7)	0.9 (0.3, 1.5)

\* mean (95 % confidence interval)  
<sup>a</sup> p<0.001, a dalimumab/MTX vs. MTX at 52 and 104 weeks and for adalimumab/MTX vs. a dalimumab at 104 weeks  
<sup>b</sup> p<0.01, for a dalimumab/MTX vs. a dalimumab at 52 weeks

### *Physical Function Response*

In studies RA-I through IV, adalimumab showed significantly greater improvement than placebo in the disability index of Health Assessment Questionnaire (HAQ-DI) from baseline to the end of study, and significantly greater improvement than placebo in the health-outcomes as assessed by The Short Form Health Survey (SF 36). Improvement was seen in both the Physical Component Summary (PCS) and the Mental Component Summary (MCS).

In Study RA-III, the mean (95 % CI) improvement in HAQ-DI from baseline at week 52 was 0.60 (0.55, 0.65) for the adalimumab patients and 0.25 (0.17, 0.33) for placebo/MTX (p<0.001) patients. Sixty-three percent of adalimumab-treated patients achieved a 0.5 or greater improvement in HAQ-DI at week 52 in the double-blind portion of the study. Eighty-two percent of these patients maintained that improvement through week 104 and a similar proportion of patients maintained this response through week 260 (5 years) of open-label treatment. Mean improvement in the SF-36 was maintained through the end of measurement at week 156 (3 years).

In Study RA-V, the HAQ-DI and the physical component of the SF-36 showed greater improvement (p<0.001) for the adalimumab/MTX combination therapy group versus either the MTX monotherapy or the adalimumab monotherapy group at Week 52, which was maintained through Week 104.

## **14.2 Juvenile Idiopathic Arthritis**

The safety and efficacy of adalimumab was assessed in Study JIA-I in patients with active polyarticular juvenile idiopathic arthritis (JIA).

### *Study JIA-I*

The safety and efficacy of adalimumab were assessed in a multicenter, randomized, withdrawal, double-blind, parallel-group study in 171 patients who were 4 to 17 years of age with polyarticular JIA. In the study, the patients were stratified into two groups: MTX-treated or non-MTX-treated. All patients had to show signs of active moderate or severe disease despite previous treatment with NSAIDs, analgesics, corticosteroids, or DMARDS. Patients who received prior treatment with any biologic DMARDS were excluded from the study.

The study included four phases: an open-label lead in phase (OL-LI; 16 weeks), a double-blind randomized withdrawal phase (DB; 32 weeks), an open-label extension phase (OLE-BSA; up to 136 weeks), and an open-label fixed dose phase (OLE-FD; 16 weeks). In the first three phases of the study, adalimumab was administered based on body surface area at a dose of 24 mg/m<sup>2</sup> up to a maximum total body dose of 40 mg subcutaneously (SC) every other week. In the OLE-FD phase, the patients were treated with 20 mg of adalimumab SC every other week if their weight was less than 30 kg and with 40 mg of adalimumab SC every other week if their weight was 30 kg or greater. Patients remained on stable doses of NSAIDs and/or prednisone ( $\leq 0.2$  mg/kg/day or 10 mg/day maximum).

Patients demonstrating a Pediatric ACR 30 response at the end of OL-LI phase were randomized into the double blind (DB) phase of the study and received either adalimumab or placebo every other week for 32 weeks or until disease flare. Disease flare was defined as a worsening of  $\geq 30$  % from baseline in  $\geq 3$  of 6 Pediatric ACR core criteria,  $\geq 2$  active joints, and improvement of  $>30$  % in no more than 1 of the 6 criteria. After 32 weeks or at the time of disease flare during the DB phase, patients were treated in the open-label extension phase based on the BSA regimen (OLE-BSA), before converting to a fixed dose regimen based on body weight (OLE-FD phase).

### Study JIA-I Clinical Response

At the end of the 16-week OL-LI phase, 94 % of the patients in the MTX stratum and 74 % of the patients in the non-MTX stratum were Pediatric ACR 30 responders. In the DB phase significantly fewer patients who received adalimumab experienced disease flare compared to placebo, both without MTX (43 % vs. 71 %) and with MTX (37 % vs. 65 %). More patients treated with adalimumab continued to show pediatric ACR 30/50/70 responses at Week 48 compared to patients treated with placebo. Pediatric ACR responses were maintained for up to two years in the OLE phase in patients who received adalimumab throughout the study.

### **14.3 Psoriatic Arthritis**

The safety and efficacy of adalimumab was assessed in two randomized, double-blind, placebo controlled studies in 413 patients with psoriatic arthritis (PsA). Upon completion of both studies, 383 patients enrolled in an open-label extension study, in which 40 mg adalimumab was administered every other week.

Study PsA-I enrolled 313 adult patients with moderately to severely active PsA ( $>3$  swollen and  $>3$  tender joints) who had an inadequate response to NSAID therapy in one of the following forms: (1) distal interphalangeal (DIP) involvement (N=23); (2) polyarticular arthritis (absence of rheumatoid nodules and presence of plaque psoriasis) (N=210); (3) arthritis mutilans (N=1); (4) asymmetric PsA (N=77); or (5) AS-like (N=2). Patients on MTX therapy (158 of 313 patients) at enrollment (stable dose of  $\leq 30$  mg/week for  $>1$  month) could continue MTX at the same dose. Doses of adalimumab 40 mg or placebo every other week were administered during the 24-week double-blind period of the study.

Compared to placebo, treatment with adalimumab resulted in improvements in the measures of disease activity (see [Table 7](#) and [Table 8](#)). Among patients with PsA who received adalimumab, the clinical responses were apparent in some patients at the time of the first visit (two weeks) and were maintained up to 88 weeks in the ongoing open-label study. Similar responses were seen in patients with each of the subtypes of psoriatic arthritis, although few patients were enrolled with the arthritis mutilans and ankylosing spondylitis-like subtypes. Responses were similar in patients who were or were not receiving concomitant MTX therapy at baseline.

Patients with psoriatic involvement of at least three percent body surface area (BSA) were evaluated for Psoriatic Area and Severity Index (PASI) responses. At 24 weeks, the proportions of patients achieving a 75 % or 90 % improvement in the PASI were 59 % and 42 % respectively, in the adalimumab group (N=69), compared to 1 % and 0 % respectively, in the placebo group (N=69) ( $p < 0.001$ ). PASI responses were apparent in some patients at the time of the first visit (two weeks). Responses were similar in patients who were or were not receiving concomitant MTX therapy at baseline.

**Table 7. ACR Response in Study PsA-I (Percent of Patients)**

	Placebo N=162	Adalimumab* N=151
<b>ACR 20</b>		
Week 12	14 %	58 %
Week 24	15 %	57 %
<b>ACR 50</b>		
Week 12	4 %	36 %
Week 24	6 %	39 %
<b>ACR 70</b>		
Week 12	1 %	20 %
Week 24	1 %	23 %

\* p<0.001 for all comparisons between adalimumab and placebo

**Table 8. Components of Disease Activity in Study PsA-I**

	Placebo N=162		Adalimumab* N=151	
	Baseline	24 weeks	Baseline	24 weeks
Parameter: median				
Number of tender joints <sup>a</sup>	23.0	17.0	20.0	5.0
Number of swollen joints <sup>b</sup>	11.0	9.0	11.0	3.0
Physician global assessment <sup>c</sup>	53.0	49.0	55.0	16.0
Patient global assessment <sup>c</sup>	49.5	49.0	48.0	20.0
Pain <sup>c</sup>	49.0	49.0	54.0	20.0
Disability index (HAQ) <sup>d</sup>	1.0	0.9	1.0	0.4
CRP (mg/dL) <sup>e</sup>	0.8	0.7	0.8	0.2

\* p<0.001 for adalimumab vs. placebo comparisons based on median changes  
<sup>a</sup> Scale 0-78  
<sup>b</sup> Scale 0-76  
<sup>c</sup> Visual analog scale; 0=best, 100=worst  
<sup>d</sup> Disability Index of the Health Assessment Questionnaire; 0=best, 3=worst; measures the patient's ability to perform the following: dress/groom, arise, eat, walk, reach, grip, maintain hygiene, and maintain daily activity.  
<sup>e</sup> Normal range: 0-0.287 mg/dL

Similar results were seen in an additional, 12-week study in 100 patients with moderate to severe psoriatic arthritis who had suboptimal response to DMARD therapy as manifested by  $\geq 3$  tender joints and  $\geq 3$  swollen joints at enrollment.

#### *Radiographic Response*

Radiographic changes were assessed in the PsA studies. Radiographs of hands, wrists, and feet were obtained at baseline and Week 24 during the double-blind period when patients were on adalimumab or placebo and at Week 48 when all patients were on open-label adalimumab. A modified Total Sharp Score (mTSS), which included distal interphalangeal joints (i.e., not identical to the TSS used for rheumatoid arthritis), was used by readers blinded to treatment group to assess the radiographs.

Adalimumab-treated patients demonstrated greater inhibition of radiographic progression compared to placebo-treated patients and this effect was maintained at 48 weeks (see [Table 9](#)).

**Table 9. Change in Modified Total Sharp Score in Psoriatic Arthritis**

	Placebo N=141	Adalimumab N=133	
	Week 24	Week 24	Week 48
Baseline mean	22.1	23.4	23.4
Mean Change $\pm$ SD	0.9 $\pm$ 3.1	-0.1 $\pm$ 1.7	-0.2 $\pm$ 4.9*

\* <0.001 for the difference between a dalimumab, Week 48 and Placebo, Week 24 (primary analysis)

*Physical Function Response*

In Study PsA-I, physical function and disability were assessed using the HAQ Disability Index (HAQ-DI) and the SF-36 Health Survey. Patients treated with 40 mg of adalimumab every other week showed greater improvement from baseline in the HAQ-DI score (mean decreases of 47 % and 49 % at Weeks 12 and 24 respectively) in comparison to placebo (mean decreases of 1 % and 3 % at Weeks 12 and 24 respectively). At Weeks 12 and 24, patients treated with adalimumab showed greater improvement from baseline in the SF-36 Physical Component Summary score compared to patients treated with placebo, and no worsening in the SF-36 Mental Component Summary score. Improvement in physical function based on the HAQ-DI was maintained for up to 84 weeks through the open-label portion of the study.

**14.4 Ankylosing Spondylitis**

The safety and efficacy of adalimumab 40 mg every other week was assessed in 315 adult patients in a randomized, 24 week double-blind, placebo-controlled study in patients with active ankylosing spondylitis (AS) who had an inadequate response to glucocorticoids, NSAIDs, analgesics, methotrexate or sulfasalazine. Active AS was defined as patients who fulfilled at least two of the following three criteria: (1) a Bath AS disease activity index (BASDAI) score  $\geq$  4 cm, (2) a visual analog score (VAS) for total back pain  $\geq$  40 mm, and (3) morning stiffness  $\geq$  1 hour. The blinded period was followed by an open-label period during which patients received adalimumab 40 mg every other week subcutaneously for up to an additional 28 weeks.

Improvement in measures of disease activity was first observed at Week 2 and maintained through 24 weeks as shown in Figure 2 and [Table 10](#).

Responses of patients with total spinal ankylosis (n=11) were similar to those without total ankylosis.

**Figure 2. ASAS 20 Response By Visit, Study AS-I**

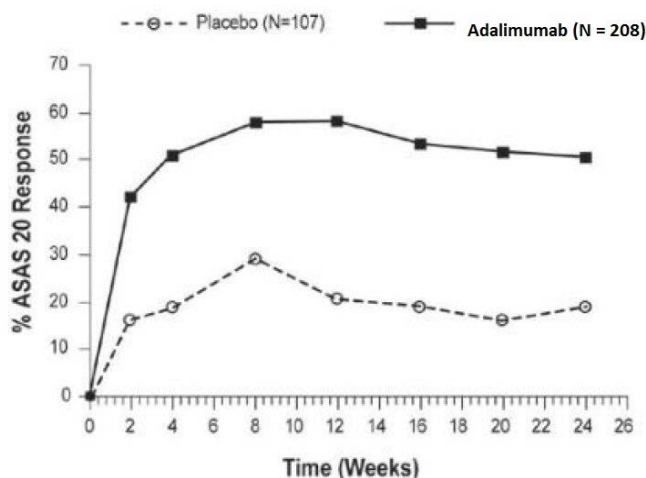

At 12 weeks, the ASAS 20/50/70 responses were achieved by 58 %, 38 %, and 23 %, respectively, of patients receiving adalimumab, compared to 21 %, 10 %, and 5 % respectively, of patients receiving placebo (p <0.001). Similar responses were seen at Week 24 and were sustained in patients receiving open-label adalimumab for up to 52 weeks.

A greater proportion of patients treated with adalimumab (22 %) achieved a low level of disease activity at 24 weeks (defined as a value <20 [on a scale of 0 to 100 mm] in each of the four ASAS response parameters) compared to patients treated with placebo (6 %).

**Table 10. Components of Ankylosing Spondylitis Disease Activity**

	<b>Placebo N=107</b>		<b>Adalimumab N=208</b>	
	Baseline mean	Week 24 mean	Baseline mean	Week 24 mean
ASAS 20 Response Criteria*				
Patient's Global Assessment of Disease Activity <sup>a</sup>	65	60	63	38
Total back pain*	67	58	65	37
Inflammation <sup>b*</sup>	6.7	5.6	6.7	3.6
BASFI <sup>c*</sup>	56	51	52	34
BASDAI <sup>d</sup> score*	6.3	5.5	6.3	3.7
BASMI <sup>e</sup> score*	4.2	4.1	3.8	3.3
Tragus to wall (cm)	15.9	15.8	15.8	15.4
Lumbar flexion (cm)	4.1	4.0	4.2	4.4
Cervical rotation (degrees)	42.2	42.1	48.4	51.6
Lumbar side flexion (cm)	8.9	9.0	9.7	11.7
Intermalleolar distance (cm)	92.9	94.0	93.5	100.8
CRP <sup>f*</sup>	2.2	2.0	1.8	0.6

<sup>a</sup> Percent of subjects with at least a 20 % and 10-unit improvement measured on a Visual Analog Scale (VAS) with 0 = "none" and 100 = "severe"

<sup>b</sup> mean of questions 5 and 6 of BASDAI (defined in 'd')

<sup>c</sup> Bath Ankylosing Spondylitis Functional Index

<sup>d</sup> Bath Ankylosing Spondylitis Disease Activity Index

<sup>e</sup> Bath Ankylosing Spondylitis Metrology Index

<sup>f</sup> C-Reactive Protein (mg/dL)

\* statistically significant for comparisons between adalimumab and placebo at Week 24

A second randomized, multicenter, double-blind, placebo-controlled study of 82 patients with ankylosing spondylitis showed similar results.

Patients treated with adalimumab achieved improvement from baseline in the Ankylosing Spondylitis Quality of Life Questionnaire (ASQoL) score (-3.6 vs. -1.1) and in the Short Form Health Survey (SF-36) Physical Component Summary (PCS) score (7.4 vs. 1.9) compared to placebo-treated patients at Week 24.

### 14.5 Adult Crohn’s Disease

The safety and efficacy of multiple doses of adalimumab were assessed in adult patients with moderately to severely active Crohn’s disease, CD, (Crohn’s Disease Activity Index (CDAI)  $\geq 220$  and  $\leq 450$ ) in randomized, double-blind, placebo-controlled studies. Concomitant stable doses of aminosalicylates, corticosteroids, and/or immunomodulatory agents were permitted, and 79 % of patients continued to receive at least one of these medications.

Induction of clinical remission (defined as CDAI  $< 150$ ) was evaluated in two studies. In Study CD-I, 299 TNF-blocker naïve patients were randomized to one of four treatment groups: the placebo group received placebo at Weeks 0 and 2, the 160/80 group received 160 mg adalimumab at Week 0 and 80 mg at Week 2, the 80/40 group received 80 mg at Week 0 and 40 mg at Week 2, and the 40/20 group received 40 mg at Week 0 and 20 mg at Week 2. Clinical results were assessed at Week 4.

In the second induction study, Study CD-II, 325 patients who had lost response to, or were intolerant to, previous infliximab therapy were randomized to receive either 160 mg adalimumab at Week 0 and 80 mg at Week 2, or placebo at Weeks 0 and 2. Clinical results were assessed at Week 4.

Maintenance of clinical remission was evaluated in Study CD-III. In this study, 854 patients with active disease received open-label adalimumab, 80 mg at week 0 and 40 mg at Week 2. Patients were then randomized at Week 4 to 40 mg adalimumab every other week, 40 mg adalimumab every week, or placebo. The total study duration was 56 weeks. Patients in clinical response (decrease in CDAI  $\geq 70$ ) at Week 4 were stratified and analysed separately from those not in clinical response at Week 4.

#### *Induction of Clinical Remission*

A greater percentage of the patients treated with 160/80 mg adalimumab achieved induction of clinical remission versus placebo at Week 4 regardless of whether the patients were TNF-blocker naïve (CD-I), or had lost response to or were intolerant to infliximab (CD-II) (see Table 11).

**Table 11. Induction of Clinical Remission in Studies CD-I and CD-II (Percent of Patients)**

	CD-I		CD-II	
	Placebo N=74	Adalimumab 160/80 mg N=76	Placebo N=166	Adalimumab 160/80 mg N=159
Week 4				
Clinical remission	12 %	36 %*	7 %	21 %*
Clinical response	34 %	58 %**	34 %	52 %**
Clinical remission is CDAI score $< 150$ ; clinical response is decrease in CDAI of at least 70 points. * $p < 0.001$ for a dalimumab vs. placebo pairwise comparison of proportions ** $p < 0.01$ for a dalimumab vs. placebo pairwise comparison of proportions				

#### *Maintenance of Clinical Remission*

In Study CD-III at Week 4, 58 % (499/854) of patients were in clinical response and were assessed in the primary analysis. At Weeks 26 and 56, greater proportions of patients who were in clinical response at Week 4 achieved clinical remission in the adalimumab 40 mg every other week maintenance group compared to patients

in the placebo maintenance group (see Table 12). The group that received adalimumab therapy every week did not demonstrate significantly higher remission rates compared to the group that received adalimumab every other week.

**Table 12. Maintenance of Clinical Remission in CD-III (Percent of Patients)**

	<b>Placebo</b>	<b>40 mg Adalimumab every other week</b>
	<b>N=170</b>	<b>N=172</b>
<b>Week 26</b>		
Clinical remission	17 %	40 %*
Clinical response	28 %	54 %*
<b>Week 56</b>		
<b>Clinical remission</b>	12 %	36 %*
<b>Clinical response</b>	18 %	43 %*
Clinical remission is CDAI score < 150; clinical response is decrease in CDAI of at least 70 points. *p<0.001 for a dalimumab vs. placebo pairwise comparisons of proportions		

Of those in response at Week 4 who attained remission during the study, patients in the adalimumab every other week group maintained remission for a longer time than patients in the placebo maintenance group. Among patients who were not in response by Week 12, therapy continued beyond 12 weeks did not result in significantly more responses.

#### **14.7 Ulcerative Colitis**

The safety and efficacy of adalimumab were assessed in adult patients with moderately to severely active ulcerative colitis (Mayo score 6 to 12 on a 12 point scale, with an endoscopy subscore of 2 to 3 on a scale of 0 to 3) despite concurrent or prior treatment with immunosuppressants such as corticosteroids, azathioprine, or 6-MP in two randomized, double-blind, placebo-controlled clinical studies (Studies UC-I and UC-II). Both studies enrolled TNF-blocker naïve patients, but Study UC-II also allowed entry of patients who lost response to or were intolerant to TNF-blockers. Forty percent (40 %) of patients enrolled in Study UC-II had previously used another TNF-blocker.

Concomitant stable doses of aminosalicylates and immunosuppressants were permitted. In Studies UC-I and II, patients were receiving aminosalicylates (69 %), corticosteroids (59 %) and/or azathioprine or 6-MP (37 %) at baseline. In both studies, 92 % of patients received at least one of these medications.

Induction of clinical remission (defined as Mayo score ≤ 2 with no individual subscores > 1) at Week 8 was evaluated in both studies. Clinical remission at Week 52 and sustained clinical remission (defined as clinical remission at both Weeks 8 and 52) were evaluated in Study UC-II.

In Study UC-I, 390 TNF-blocker naïve patients were randomized to one of three treatment groups for the primary efficacy analysis. The placebo group received placebo at Weeks 0, 2, 4 and 6. The 160/80 group received 160 mg adalimumab at Week 0 and 80 mg at Week 2, and the 80/40 group received 80 mg adalimumab at Week 0 and 40 mg at Week 2. After Week 2, patients in both adalimumab treatment groups received 40 mg every other week.

In Study UC-II, 518 patients were randomized to receive either adalimumab 160 mg at Week 0, 80 mg at Week 2, and 40 mg every other week starting at Week 4 through Week 50, or placebo starting at Week 0 and every other week through Week 50. Corticosteroid taper was permitted starting at Week 8.

In both Studies UC-I and UC-II, a greater percentage of the patients treated with 160/80 mg of adalimumab compared to patients treated with placebo achieved induction of clinical remission. In Study UC-II, a greater

percentage of the patients treated with 160/80 mg of adalimumab compared to patients treated with placebo achieved sustained clinical remission (clinical remission at both Weeks 8 and 52) ([Table 13](#)).

**Table 13. Induction of Clinical Remission in Studies UC-I and UC-II and Sustained Clinical Remission in Study UC-II (Percent of Patients)**

	Study UC-I			Study UC-II		
	Placebo N=130	Adalimumab 160/80 mg N=130	Treatment Difference (95% CI)	Placebo N=246	Adalimumab 160/80 mg N=248	Treatment Difference (95% CI)
Induction of Clinical Remission (Clinical Remission at Week 8)	9.2 %	18.5 %	9.3 %* (0.9 %, 17.6 %)	9.3 %	16.5 %	7.2 %* (1.2 %, 12.9 %)
Sustained Clinical Remission (Clinical Remission at both Weeks 8 and 52)	N/A	N/A	N/A	4.1 %	8.5 %	4.4 %* (0.1 %, 8.6 %)
Clinical remission is defined as Mayo score $\leq 2$ with no individual subscores $> 1$ . CI=Confidence interval * p<0.05 for adalimumab vs. placebo pairwise comparison of proportions						

In Study UC-I, there was no statistically significant difference in clinical remission observed between the adalimumab 80/40 mg group and the placebo group at Week 8.

In Study UC-II, 17.3% (43/248) in the adalimumab group were in clinical remission at Week 52 compared to 8.5% (21/246) in the placebo group (treatment difference: 8.8%; 95% confidence interval (CI): [2.8%, 14.5%]; p<0.05).

In the subgroup of patients in Study UC-II with prior TNF-blocker use, the treatment difference for induction of clinical remission appeared to be lower than that seen in the whole study population, and the treatment differences for sustained clinical remission and clinical remission at Week 52 appeared to be similar to those seen in the whole study population. The subgroup of patients with prior TNF-blocker use achieved induction of clinical remission at 9% (9/98) in the adalimumab group versus 7% (7/101) in the placebo group, and sustained clinical remission at 5% (5/98) in the adalimumab group versus 1% (1/101) in the placebo group. In the subgroup of patients with prior TNF-blocker use, 10% (10/98) were in clinical remission at Week 52 in the adalimumab group versus 3% (3/101) in the placebo group.

#### 14.8 Plaque Psoriasis

The safety and efficacy of adalimumab were assessed in randomized, double-blind, placebo-controlled studies in 1696 adult subjects with moderate to severe chronic plaque psoriasis (Ps) who were candidates for systemic therapy or phototherapy.

Study Ps-I evaluated 1212 subjects with chronic Ps with  $\geq 10$  % body surface area (BSA) involvement, Physician's Global Assessment (PGA) of at least moderate disease severity, and Psoriasis Area and Severity Index (PASI)  $\geq 12$  within three treatment periods. In period A, subjects received placebo or adalimumab at an initial dose of 80 mg at Week 0 followed by a dose of 40 mg every other week starting at Week 1. After 16 weeks of therapy, subjects who achieved at least a PASI 75 response at Week 16, defined as a PASI score improvement of at least 75 % relative to baseline, entered period B and received open-label 40 mg adalimumab every other week. After 17 weeks of open label therapy, subjects who maintained at least a PASI 75 response at

Week 33 and were originally randomized to active therapy in period A were re-randomized in period C to receive 40 mg adalimumab every other week or placebo for an additional 19 weeks. Across all treatment groups the mean baseline PASI score was 19 and the baseline Physician’s Global Assessment score ranged from “moderate” (53 %) to “severe” (41 %) to “very severe” (6 %).

Study Ps-II evaluated 99 subjects randomized to adalimumab and 48 subjects randomized to placebo with chronic plaque psoriasis with  $\geq 10$  % BSA involvement and PASI  $\geq 12$ . Subjects received placebo, or an initial dose of 80 mg adalimumab at Week 0 followed by 40 mg every other week starting at Week 1 for 16 weeks. Across all treatment groups the mean baseline PASI score was 21 and the baseline PGA score ranged from “moderate” (41 %) to “severe” (51 %) to “very severe” (8 %).

Studies Ps-I and II evaluated the proportion of subjects who achieved “clear” or “minimal” disease on the 6-point PGA scale and the proportion of subjects who achieved a reduction in PASI score of at least 75 % (PASI 75) from baseline at Week 16 (see Table 14 and 15).

Additionally, Study Ps-I evaluated the proportion of subjects who maintained a PGA of “clear” or “minimal” disease or a PASI 75 response after Week 33 and on or before Week 52.

**Table 14. Efficacy Results at 16 Weeks in Study Ps-I Number of Subjects (%)**

	<b>Adalimumab 40 mg every other week</b>	<b>Placebo</b>
	N = 814	N = 398
PGA: Clear or minimal*	506 (62 %)	17 (4 %)
PASI 75	578 (71 %)	26 (7 %)
* Clear = no plaque elevation, no scale, plus or minus hyperpigmentation or diffuse pink or red coloration Minimal = possible but difficult to ascertain whether there is slight elevation of plaque above normal skin, plus or minus surface dryness with some white coloration, plus or minus up to red coloration		

**Table 15. Efficacy Results at 16 Weeks in Study Ps-II Number of Subjects (%)**

	<b>Adalimumab 40 mg every other week</b>	<b>Placebo</b>
	N = 99	N = 48
PGA: Clear or minimal*	70 (71 %)	5 (10 %)
PASI 75	77 (78 %)	9 (19 %)
* Clear = no plaque elevation, no scale, plus or minus hyperpigmentation or diffuse pink or red coloration Minimal = possible but difficult to ascertain whether there is slight elevation of plaque above normal skin, plus or minus surface dryness with some white coloration, plus or minus up to red coloration		

Additionally, in Study Ps-I, subjects on adalimumab who maintained a PASI 75 were re-randomized to adalimumab (N = 250) or placebo (N = 240) at Week 33. After 52 weeks of treatment with adalimumab, more subjects on adalimumab maintained efficacy when compared to subjects who were re-randomized to placebo based on maintenance of PGA of “clear” or “minimal” disease (68 % vs. 28 %) or a PASI 75 (79 % vs. 43 %).

A total of 347 stable responders participated in a withdrawal and retreatment evaluation in an open-label extension study. Median time to relapse (decline to PGA “moderate” or worse) was approximately 5 months. During the withdrawal period, no subject experienced transformation to either pustular or erythrodermic psoriasis. A total of 178 subjects who relapsed re-initiated treatment with 80 mg of adalimumab, then 40 mg every other week beginning at week 1. At week 16, 69 % (123/178) of subjects had a response of PGA “clear” or “minimal”.

A randomized, double-blind study (Study Ps-III) compared the efficacy and safety of adalimumab versus placebo in 217 adult subjects. Subjects in the study had to have chronic plaque psoriasis of at least moderate severity on the PGA scale, fingernail involvement of at least moderate severity on a 5-point Physician's Global Assessment of Fingernail Psoriasis (PGA-F) scale, a Modified Nail Psoriasis Severity Index (mNAPSI) score for the target-fingernail of  $\geq 8$ , and either a BSA involvement of at least 10 % or a BSA involvement of at least 5 % with a total mNAPSI score for all fingernails of  $\geq 20$ . Subjects received an initial dose of 80 mg adalimumab followed by 40 mg every other week (starting one week after the initial dose) or placebo for 26 weeks followed by open-label adalimumab-treatment for an additional 26 weeks. This study evaluated the proportion of subjects who achieved "clear" or "minimal" assessment with at least a 2-grade improvement on the PGA-F scale and the proportion of subjects who achieved at least a 75 % improvement from baseline in the mNAPSI score (mNAPSI 75) at Week 26.

At Week 26, a higher proportion of subjects in the adalimumab group than in the placebo group achieved the PGA-F endpoint. Furthermore, a higher proportion of subjects in the adalimumab group than in the placebo group achieved mNAPSI 75 at Week 26 (see Table 16).

**Table 16. Efficacy Results at 26 Weeks**

Endpoint	Adalimumab 40 mg Every other week* N=109	Placebo N=108
PGA-F: $\geq 2$ -grade improvement and <i>clear</i> or <i>minimal</i>	49 %	7 %
mNAPSI 75	47 %	3 %

\* Subjects received 80 mg of adalimumab at Week 0, followed by 40 mg every other week starting at Week 1.

Nail pain was also evaluated and improvement in nail pain was observed in Study Ps-III.

## 15 REFERENCES

1. National Cancer Institute. Surveillance, Epidemiology, and End Results Database (SEER) Program. SEER Incidence Crude Rates, 17 Registries, 2000-2007.

## 16 HOW SUPPLIED/STORAGE AND HANDLING

### **HYRIMOZ single-dose pre-filled Sensoready® Pen and HYRIMOZ single-dose pre-filled syringe with BD UltraSafe Passive™ Needle Guard and add-on finger flange**

HYRIMOZ (adalimumab-adaz) is supplied as a preservative-free, sterile clear, colorless to slightly yellowish solution for subcutaneous administration. The following packaging configurations are available.

Each HYRIMOZ single-dose pre-filled Sensoready® Pen and HYRIMOZ single-dose pre-filled syringe contains 40 mg/0.8 mL of adalimumab in a 1 mL single-dose syringe with a 27-gauge, ½-inch needle. The gray needle cover within the needle cap contains natural rubber (a derivative of latex) that may cause allergic reactions in individuals sensitive to latex.

<b>40 mg/0.8 mL</b> single-dose pre-filled syringe with BD UltraSafe Passive™ Needle Guard	Carton of 2	NDC 61314-876-02
--	-------------	------------------

<b>40 mg/0.8 mL</b> Sensoready® Pen	single-dose	pre-filled	Carton of 2	NDC 61314-871-02
<b>40 mg/0.8 mL</b> Sensoready® Pen	single-dose	pre-filled	Carton of 6 (3 x 2)	NDC 61314-871-06

- **HYRIMOZ single-dose pre-filled syringe – 40 mg/0.8 mL (2 count)**

HYRIMOZ is supplied in a carton containing 2 blister packages. Each blister package consists of a single-dose, 1 mL pre-filled glass syringe with a fixed 27 gauge, ½ inch needle, providing 40 mg/0.8 mL of HYRIMOZ. The gray needle cap contains natural rubber. The NDC number is 61314-876-02.

- **HYRIMOZ single-dose pre-filled Sensoready® Pen – 40 mg/0.8 mL (2 count)**

HYRIMOZ is supplied in a carton containing 2 single-dose pre-filled Sensoready® Pens. Each Pen consists of a single-dose, 1 mL pre-filled glass syringe with a fixed 27 gauge, ½ inch needle, providing 40 mg/0.8 mL of HYRIMOZ. The gray needle cover within the needle cap contains natural rubber. The NDC number is 61314-871-02.

- **HYRIMOZ single-dose pre-filled Sensoready® Pen – 40 mg/0.8 mL – Starter Pack for Crohn’s Disease or Ulcerative Colitis (6 count)**

HYRIMOZ is supplied in a multipack containing 3x2 packs. Each 2-count pack consists of 2 single-dose pre-filled Sensoready® Pens, containing a 1 mL pre-filled glass syringe with a fixed 27 gauge, ½ inch needle, providing 40 mg/0.8 mL of HYRIMOZ. The gray needle cap within the needle cover contains natural rubber. The NDC number is 61314-871-06.

#### *Storage and Stability*

Do not use beyond the expiration date on the container. HYRIMOZ must be refrigerated at 36°F to 46°F (2°C to 8°C). **DO NOT FREEZE**. Do not use if frozen even if it has been thawed.

Store in original carton until time of administration to protect from light.

If needed, for example when traveling, HYRIMOZ may be stored at room temperature up to a maximum of 77°F (25°C) for a period of up to 14 days, with protection from light. HYRIMOZ should be discarded if not used within the 14-day period. Record the date when HYRIMOZ is first removed from the refrigerator in the spaces provided on the carton.

Do not store HYRIMOZ in extreme heat or cold.

## **17 PATIENT COUNSELING INFORMATION**

Advise the patient to read the FDA-approved patient labeling (Medication Guide and Instructions for Use).

#### *Patient Counseling*

Provide the HYRIMOZ **Medication Guide** to patients or their caregivers, and provide them an opportunity to read it and ask questions prior to initiation of therapy and prior to each time the prescription is renewed. If patients develop signs and symptoms of infection, instruct them to seek medical evaluation immediately.

Advise patients of the potential benefits and risks of HYRIMOZ.

- **Infections**

Inform patients that HYRIMOZ may lower the ability of their immune system to fight infections. Instruct patients of the importance of contacting their doctor if they develop any symptoms of infection, including tuberculosis, invasive fungal infections, and reactivation of hepatitis B virus infections.

- **Malignancies**

Counsel patients about the risk of malignancies while receiving HYRIMOZ.

- **Allergic Reactions**

Advise patients to seek immediate medical attention if they experience any symptoms of severe allergic reactions. Advise latex-sensitive patients that the following components contain dry natural rubber (a derivative of latex) that may cause allergic reactions in individuals sensitive to latex: the gray needle cap of the HYRIMOZ single-dose pre-filled syringe and the gray needle cover within the needle cap of the HYRIMOZ single-dose pre-filled Sensoready® Pen [*see How Supplied/Storage and Handling (16) for specific information*].

- **Other Medical Conditions**

Advise patients to report any signs of new or worsening medical conditions such as congestive heart failure, neurological disease, autoimmune disorders, or cytopenias. Advise patients to report any symptoms suggestive of a cytopenia such as bruising, bleeding, or persistent fever.

#### *Instructions on Injection Technique*

Inform patients that the first injection is to be performed under the supervision of a qualified health care professional. If a patient or caregiver is to administer HYRIMOZ, instruct them in injection techniques and assess their ability to inject subcutaneously to ensure the proper administration of HYRIMOZ [*see [Instructions for Use](#)*].

For patients who will use the HYRIMOZ single-dose pre-filled Sensoready® Pen, tell them that they:

- will hear **2 loud clicks**. The **1<sup>st</sup> click** indicates that the injection has **started**. Several seconds later a **2<sup>nd</sup> click** will indicate that the injection is almost **finished**.
- must keep holding the HYRIMOZ single-dose pre-filled Sensoready® Pen firmly against their skin until they see a green indicator fill the window and stop moving.

Instruct patients to dispose of their used syringes or used Sensoready® Pens in a FDA-cleared sharps disposal container immediately after use. **Instruct patients not to dispose of syringes or pens in their household trash.** Instruct patients that if they do not have a FDA-cleared sharps disposal container, they may use a household container that is made of a heavy-duty plastic, can be closed with a tight-fitting and puncture-resistant lid without sharps being able to come out, upright and stable during use, leak-resistant, and properly labeled to warn of hazardous waste inside the container.

Instruct patients that when their sharps disposal container is almost full, they will need to follow their community guidelines for the correct way to dispose of their sharps disposal container. Instruct patients that there may be state or local laws regarding disposal of used needles and syringes. Refer patients to the FDA's website at <http://www.fda.gov/safesharpsdisposal> for more information about safe sharps disposal, and for specific information about sharps disposal in the state that they live in.

**Instruct patients not to dispose of their used sharps disposal container in their household trash unless their community guidelines permit this. Instruct patients not to recycle their used sharps disposal container.**

Manufactured by:

Sandoz Inc.

Princeton, NJ 08540

US License No. 2003

**MEDICATION GUIDE**  
**HYRIMOZ™ (hye-RI-moze)**  
**(adalimumab-adaz)**  
**Injection, for subcutaneous use**

Read the Medication Guide that comes with HYRIMOZ before you start taking it and each time you get a refill. There may be new information. This Medication Guide does not take the place of talking with your doctor about your medical condition or treatment.

**What is the most important information I should know about HYRIMOZ?**

HYRIMOZ is a medicine that affects your immune system. HYRIMOZ can lower the ability of your immune system to fight infections.

**Serious infections have happened in people taking adalimumab products. These serious infections include tuberculosis (TB) and infections caused by viruses, fungi or bacteria that have spread throughout the body. Some people have died from these infections.**

- Your doctor should test you for TB before starting HYRIMOZ.
- Your doctor should check you closely for signs and symptoms of TB during treatment with HYRIMOZ. You should not start taking HYRIMOZ if you have any kind of infection unless your doctor says it is okay.

**Before starting HYRIMOZ, tell your doctor if you:**

- think you have an infection or have symptoms of infection such as:
  - fever, sweats or chills
  - muscle aches
  - cough
  - shortness of breath
  - blood in phlegm
  - warm, red, or painful skin or sores on your body
  - diarrhea or stomach pain
  - burning when you urinate or urinate more often than normal
  - feel very tired
  - weight loss
- are being treated for an infection.
- get a lot of infections or have infections that keep coming back.
- have diabetes.
- have TB, or have been in close contact with someone with TB.
- were born in, lived in, or traveled to countries where there is more risk for getting TB. Ask your doctor if you are not sure.
- live or have lived in certain parts of the country (such as the Ohio and Mississippi River valleys) where there is an increased risk for getting certain kinds of fungal infections (histoplasmosis, coccidioidomycosis, or blastomycosis). These infections may happen or become more severe if you use HYRIMOZ. Ask your doctor if you do not know if you have lived in an area where these infections are common.
- have or have had hepatitis B.
- use the medicine ORENCIA® (abatacept), KINERET® (anakinra), RITUXAN® (rituximab), IMURAN® (azathioprine), or PURINETHOL® (6-mercaptopurine, 6-MP).
- are scheduled to have major surgery.

**After starting HYRIMOZ, call your doctor right away** if you have an infection, or any sign of an infection. HYRIMOZ can make you more likely to get infections or make any infection that you may have worse.

**Cancer**

- For children and adults taking Tumor Necrosis Factor (TNF)-blockers, including HYRIMOZ, the chances of getting cancer may increase.
- There have been cases of unusual cancers in children, teenagers, and young adults using TNF-blockers.
- People with rheumatoid arthritis (RA), especially more serious RA, may have a higher chance for getting a kind of cancer called lymphoma.
- If you use TNF-blockers including HYRIMOZ, your chance of getting two types of skin cancer may increase (basal cell cancer and squamous cell cancer of the skin). These types of cancer are generally not life-threatening if treated. Tell your doctor if you have a bump or open sore that does not heal.
- Some people receiving TNF-blockers such as HYRIMOZ developed a rare type of cancer called hepatosplenic T-cell lymphoma. This type of cancer often results in death. Most of these people were male teenagers or young men. Also, most people were being treated for Crohn's disease or ulcerative colitis with another medicine called IMURAN® (azathioprine) or PURINETHOL® (6-mercaptopurine, 6-MP).  
See "**What are the possible side effects of HYRIMOZ**".

**What is HYRIMOZ?**

HYRIMOZ is a medicine called a Tumor Necrosis Factor (TNF)-blocker. HYRIMOZ is used:

- to reduce the signs and symptoms of:
  - **moderate to severe rheumatoid arthritis (RA) in adults.** HYRIMOZ can be used alone, with methotrexate, or with certain other medicines.
  - **moderate to severe polyarticular juvenile idiopathic arthritis (JIA) in children 4 years and older.** HYRIMOZ can be used alone, with methotrexate, or with certain other medicines.
  - **psoriatic arthritis (PsA) in adults.** HYRIMOZ can be used alone or with certain other medicines.
  - **ankylosing spondylitis (AS) in adults.**
  - **moderate to severe Crohn's disease (CD) in adults** when other treatments have not worked well enough.
- in adults, to help get **moderate to severe ulcerative colitis (UC)** under control (induce remission) and keep it under control (sustain remission) when certain other medicines have not worked well enough. It is not known if adalimumab products are effective in people who stopped responding to or could not tolerate TNF-blocker medicines.
- **to treat moderate to severe chronic (lasting a long time) plaque psoriasis (Ps) in adults** who have the condition in many areas of their body and who may benefit from taking injections or pills (systemic therapy) or phototherapy (treatment using ultraviolet light alone or with pills).

### What should I tell my doctor before taking HYRIMOZ?

HYRIMOZ may not be right for you. Before starting HYRIMOZ, tell your doctor about all of your health conditions, including if you:

- have an infection. See **“What is the most important information I should know about HYRIMOZ?”**
- have or have had cancer.
- have any numbness or tingling or have a disease that affects your nervous system such as multiple sclerosis or Guillain-Barré syndrome.
- have or have had heart failure.
- have recently received or are scheduled to receive a vaccine. You may receive vaccines, except for live vaccines while using HYRIMOZ. Children should be brought up to date with all vaccines before starting HYRIMOZ.
- are allergic to rubber or latex. Tell your doctor if you have any allergies to rubber or latex.
  - The following components contain dry natural rubber (a derivative of latex), which may cause allergic reactions in individuals sensitive to latex: the gray needle cap of the HYRIMOZ single-dose pre-filled syringe and the gray needle cover within the needle cap of the HYRIMOZ single-dose pre-filled Sensoready® Pen.
- are allergic to HYRIMOZ or to any of its ingredients. See the end of this Medication Guide for a list of ingredients in HYRIMOZ.
- are pregnant or plan to become pregnant. It is not known if HYRIMOZ will harm your unborn baby. HYRIMOZ should only be used during a pregnancy if needed.
- have a baby and you were using HYRIMOZ during your pregnancy. Tell your baby's doctor before your baby receives any vaccines.
- are breastfeeding or plan to breastfeed. You and your doctor should decide if you will breastfeed or use HYRIMOZ. You should not do both.

**Tell your doctor about all the medicines you take**, including prescription and over-the-counter medicines, vitamins, and herbal supplements.

### Especially tell your doctor if you use:

- ORENCIA® (abatacept), KINERET® (anakinra), REMICADE® (infliximab), ENBREL® (etanercept), CIMZIA® (certolizumab pegol) or SIMPONI® (golimumab), because you should not use HYRIMOZ while you are also using one of these medicines.
- RITUXAN® (rituximab). Your doctor may not want to give you HYRIMOZ if you have received RITUXAN® (rituximab) recently.
- IMURAN® (azathioprine) or PURINETHOL® (6-mercaptopurine, 6-MP).

**Keep a list of your medicines with you to show your doctor and pharmacist each time you get a new medicine.**

### How should I take HYRIMOZ?

- HYRIMOZ is given by an injection under the skin. Your doctor will tell you how often to take an injection of HYRIMOZ. This is based on your condition to be treated. **Do not inject HYRIMOZ more often than you were prescribed.**
- See the **Instructions for Use** inside the carton for complete instructions for the right way to prepare and inject HYRIMOZ.
- Make sure you have been shown how to inject HYRIMOZ before you do it yourself. You can call your doctor or 1-800-525-8747 if you have any questions about giving yourself an injection. Someone you know can also help you with your injection after they have been shown how to prepare and inject HYRIMOZ.

- **Do not** try to inject HYRIMOZ yourself until you have been shown the right way to give the injections. If your doctor decides that you or a caregiver may be able to give your injections of HYRIMOZ at home, you should receive training on the right way to prepare and inject HYRIMOZ.
- **Do not miss** any doses of HYRIMOZ unless your doctor says it is okay. If you forget to take HYRIMOZ, inject a dose as soon as you remember. Then, take your next dose at your regular scheduled time. This will put you back on schedule. In case you are not sure when to inject HYRIMOZ, call your doctor or pharmacist.
- If you take more HYRIMOZ than you were told to take, call your doctor.

### What are the possible side effects of HYRIMOZ?

HYRIMOZ can cause serious side effects, including:

see "**What is the most important information I should know about HYRIMOZ?**":

- **Serious Infections.** Your doctor will examine you for TB and perform a test to see if you have TB. If your doctor feels that you are at risk for TB, you may be treated with medicine for TB before you begin treatment with HYRIMOZ and during treatment with HYRIMOZ. Even if your TB test is negative your doctor should carefully monitor you for TB infections while you are taking HYRIMOZ. People who had a negative TB skin test before receiving adalimumab products have developed active TB. Tell your doctor if you have any of the following symptoms while taking or after taking HYRIMOZ:
  - cough that does not go away
  - low grade fever
  - weight loss
  - loss of body fat and muscle (wasting)
- **Hepatitis B infection in people who carry the virus in their blood.** If you are a carrier of the hepatitis B virus (a virus that affects the liver), the virus can become active while you are using HYRIMOZ. Your doctor should do blood tests before you start treatment, while you are using HYRIMOZ, and for several months after you stop treatment with HYRIMOZ. Tell your doctor if you have any of the following symptoms of a possible hepatitis B infection:
  - muscle aches
  - feel very tired
  - dark urine
  - skin or eyes look yellow
  - little or no appetite
  - vomiting
  - clay-colored bowel movement
  - fever
  - chills
  - stomach discomfort
  - skin rash
- **Allergic reactions.** Allergic reactions can happen in people who use HYRIMOZ. Call your doctor or get medical help right away if you have any of these symptoms of a serious allergic reaction:
  - hives
  - trouble breathing
  - swelling of your face, eyes, lips or mouth
- **Nervous system problems.** Signs and symptoms of a nervous system problem include: numbness or tingling, problems with your vision, weakness in your arms or legs, and dizziness.
- **Blood problems.** Your body may not make enough of the blood cells that help fight infections or help to stop bleeding. Symptoms include a fever that does not go away, bruising or bleeding very easily, or looking very pale.
- **New heart failure or worsening of heart failure you already have. Call your doctor right away** if you get new worsening symptoms of heart failure while taking HYRIMOZ, including:
  - shortness of breath
  - sudden weight gain
  - swelling of your ankles or feet
- **Immune reactions including a lupus-like syndrome.** Symptoms include chest discomfort or pain that does not go away, shortness of breath, joint pain, or a rash on your cheeks or arms that gets worse in the sun. Symptoms may improve when you stop HYRIMOZ.
- **Liver Problems.** Liver problems can happen in people who use TNF-blocker medicines. These problems can lead to liver failure and death. Call your doctor right away if you have any of these symptoms:
  - feel very tired
  - poor appetite or vomiting
  - skin or eyes look yellow
  - pain on the right side of your stomach (abdomen)
- **Psoriasis.** Some people using adalimumab products had new psoriasis or worsening of psoriasis they already had. Tell your doctor if you develop red scaly patches or raised bumps that are filled with pus. Your doctor may decide to stop your treatment with HYRIMOZ.

**Call your doctor or get medical care right away if you develop any of the above symptoms. Your treatment with HYRIMOZ may be stopped.**

### Common side effects with HYRIMOZ include:

- injection site reactions: redness, rash, swelling, itching, or bruising. These symptoms usually will go away within a few days. Call your doctor right away if you have pain, redness or swelling around the injection site that does not go away within a few days or gets worse.

- upper respiratory infections (including sinus infections)
- headaches
- rash

These are not all the possible side effects with HYRIMOZ. Tell your doctor if you have any side effect that bothers you or that does not go away. Ask your doctor or pharmacist for more information.

Call your doctor for medical advice about side effects. You may report side effects to the FDA at 1-800-FDA-1088.

#### How should I store HYRIMOZ?

- Store HYRIMOZ in the refrigerator at 36°F to 46°F (2°C to 8°C). Store HYRIMOZ in the original carton until use to protect it from light.
- **Do not freeze HYRIMOZ.** Do not use HYRIMOZ if frozen, even if it has been thawed.
- Refrigerated HYRIMOZ may be used until the expiration date printed on the carton of the HYRIMOZ single-dose pre-filled Sensoready® Pen or the HYRIMOZ single-dose pre-filled syringe. Do not use HYRIMOZ after the expiration date.
- If needed, for example when you are traveling, you may also store HYRIMOZ at room temperature up to 77°F (25°C) for up to 14 days. Store HYRIMOZ in the original carton until use to protect it from light. Throw away HYRIMOZ if it has been kept at room temperature and not been used within 14 days.
- Record the date you first remove HYRIMOZ from the refrigerator in the spaces provided on the carton.
- Do not store HYRIMOZ in extreme heat or cold.
- The solution should be clear and colorless to slightly yellow. Do not use HYRIMOZ if the solution is cloudy, discolored, or has flakes or particles in it.
- Do not drop or crush HYRIMOZ. The pre-filled syringe is glass.

**Keep HYRIMOZ, injection supplies, and all other medicines out of the reach of children.**

#### General information about the safe and effective use of HYRIMOZ

Medicines are sometimes prescribed for purposes other than those listed in a Medication Guide. Do not use HYRIMOZ for a condition for which it was not prescribed. Do not give HYRIMOZ to other people, even if they have the same condition. It may harm them.

This Medication Guide summarizes the most important information about HYRIMOZ. If you would like more information, talk with your doctor. You can ask your doctor or pharmacist for information about HYRIMOZ that is written for health professionals. For more information go to [www.HYRIMOZ.com](http://www.HYRIMOZ.com) or you can enroll in a patient support program by calling 1-800-525-8747.

#### What are the ingredients in HYRIMOZ?

**Active ingredient:** adalimumab-adaz

HYRIMOZ single-dose pre-filled Sensoready® Pen 40 mg/0.8 mL and HYRIMOZ single-dose pre-filled syringe with BD UltraSafe Passive Needle Guard 40 mg/0.8 mL:

**Inactive ingredients:** adipic acid, citric acid monohydrate, mannitol, polysorbate 80, sodium chloride, and Water for Injection, USP.

**SANDOZ** A Novartis  
Division

**Manufactured by:**

Sandoz Inc.  
Princeton, NJ 08540  
US License No. 2003  
Made in Austria & U.S.A.

## INSTRUCTIONS FOR USE

HYRIMOZ™ (hye-RI-moze)

(adalimumab-adaz)

### Single-dose pre-filled Syringe with BD UltraSafe Passive™ Needle Guard and finger flange injection, for subcutaneous use

To help avoid possible infections and to ensure that you use the medicine correctly, it is important that you follow these instructions.

Be sure that you read, understand, and follow this Instructions for Use before injecting HYRIMOZ. Your doctor should show you how to prepare and inject HYRIMOZ properly using the HYRIMOZ single-dose pre-filled syringe before you use it for the first time. Talk to your doctor if you have any questions.

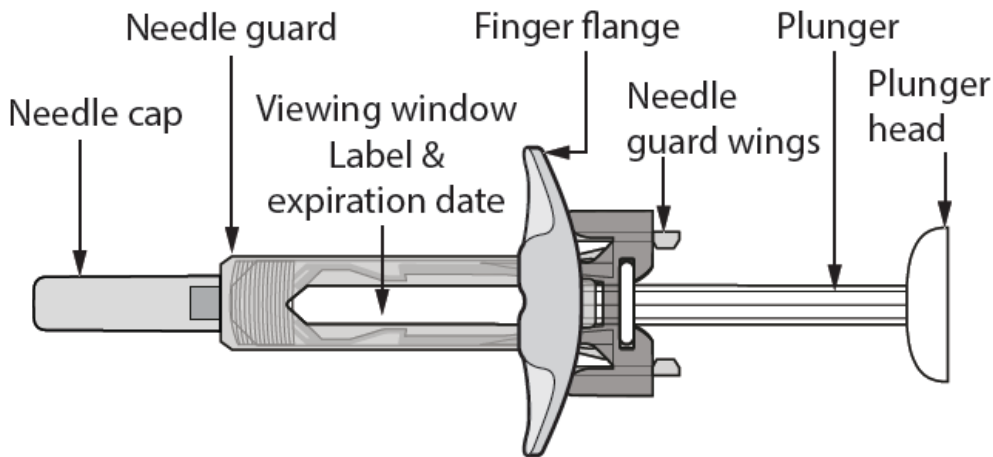

Figure A: HYRIMOZ pre-filled syringe with BD UltraSafe Passive™ Needle Guard and finger flange

#### It is important that you:

- **do not use** the pre-filled syringe if the seals of the blister are broken, as it may not be safe for you to use.
- **do not open** the outer box until you are ready to use the pre-filled syringe.
- **never leave** the pre-filled syringe unattended where others might misuse it.
- **do not shake** the pre-filled syringe.
- **do not handle the pre-filled syringes if you are sensitive to latex. The needle caps of the pre-filled syringes contain latex.**
- **do not remove** the needle cap until just before you give the injection.
- **be careful not to touch the needle guard wings** before use. Touching them may cause the needle guard to be activated too early.
- **do not remove** the finger flange before the injection.
- **inject** HYRIMOZ 15 to 30 minutes after taking it out of the refrigerator for a more comfortable injection.
- throw away (dispose of) the used pre-filled syringe right away after use. **Do not re-use a pre-filled syringe.** See “4. Disposing of used pre-filled syringes” at the end of this Instructions for Use.

#### How should you store HYRIMOZ single-dose pre-filled syringe?

- Store your outer carton of pre-filled syringes in a refrigerator between 36°F to 46°F (2°C to 8°C).
- If needed, for example if you are traveling, you may store the pre-filled syringe at room temperature up to 77°F (25°C) for up to 14 days.
- Throw away the pre-filled syringe that has been stored at room temperature after 14 days.
- Record the date you first remove HYRIMOZ from the refrigerator in the spaces provided on the carton.
- Keep your pre-filled syringes in the original carton until ready to use to protect from light.

- Do not store your pre-filled syringes in extreme heat or cold.
- Do not freeze your pre-filled syringes.
- Do not drop or crush HYRIMOZ. The pre-filled syringe is glass.

**Keep HYRIMOZ and all medicines out of the reach of children.**

### What do you need for your injection?

Included in your pre-filled syringe carton are:

- HYRIMOZ pre-filled syringes (see **Figure A**). Each pre-filled syringe contains 40 mg/0.8 mL of adalimumab-adaz.

Not included in your HYRIMOZ pre-filled syringe carton are:

- Alcohol wipe
- Cotton ball or gauze
- Sharps disposal container See “**4. Disposing of used pre-filled syringes**” at the end of this Instructions for Use.
- Adhesive bandage

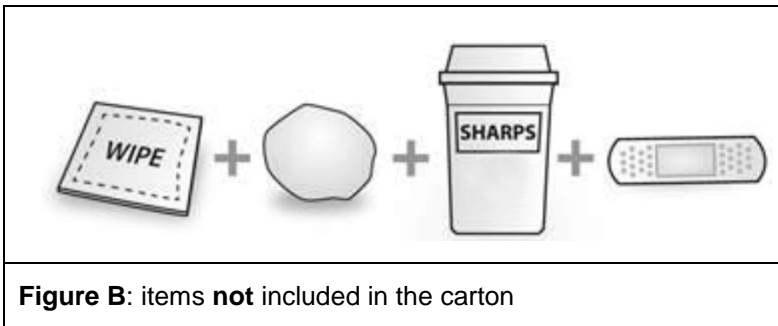

### Before your injection

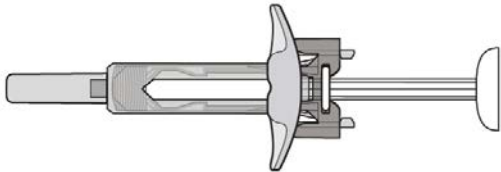

**Figure C:** needle guard is not activated – the single-dose pre-filled syringe is ready for use

- In Figure C the needle guard is **not activated**.
- The pre-filled syringe is ready for use (see **Figure C**).

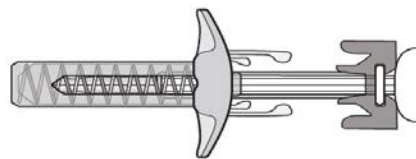

**Figure D:** needle guard is activated – **do not use**

- In Figure D the needle guard of your pre-filled syringe is **activated**.
- **Do not use** the pre-filled syringe (see **Figure D**).

## Preparing the pre-filled syringe

- For a more comfortable injection, take the carton containing the pre-filled syringe out of the refrigerator and leave it **unopened** on your work surface for about 15 to 30 minutes to allow it to reach room temperature. **Do not** try to warm the pre-filled syringe by using a heat source such as hot water or a microwave.
- Take the pre-filled syringe out of the blister. The solution should be clear, colorless to slightly yellow. Do not use a pre-filled syringe if the solution is cloudy, discolored, or has flakes or particles in it. If you are not sure what color the solution should be, contact your pharmacist for help.
- **Do not use** the pre-filled syringe if it is broken or the needle guard is activated. Return the pre-filled syringe and the package it came in to the pharmacy.
- Look at the expiration date (EXP) on your pre-filled syringe. Do not use your pre-filled syringe if the expiration date has passed.

Contact your pharmacist if:

- you are unsure about the color of the solution in the pre-filled syringe.
- the pre-filled syringe is broken or the needle guard is activated.
- the expiration date has passed.

### 1. Choosing your injection site

- The recommended injection site is the front of your thighs. You may also use the lower abdomen, but not the area 2 inches (5 cm) around your navel (belly button) (see **Figure E**).
- Choose a different site each time you give yourself an injection.
- **Do not** inject into areas where the skin is tender, bruised, red, scaly, or hard. Avoid areas with scars or stretch marks. If you have psoriasis, you should **not** inject directly into areas with psoriasis plaques.

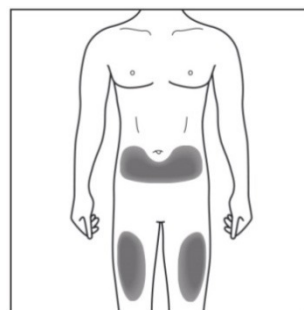

**Figure E:** choose your injection site

### 2. Cleaning your injection site

- Wash your hands well with soap and water.
- Using a circular motion, clean the injection site with an alcohol wipe. Let it dry before injecting (see **Figure F**).
- **Do not** touch the cleaned area before injecting.

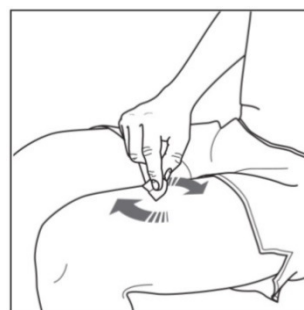

**Figure F:** clean your injection site

### 3. Giving your injection

- Carefully pull the needle cap straight off to remove it from the pre-filled syringe (see **Figure G**).
- Throw away (discard) the needle cap.
- You may see a drop of liquid at the end of the needle. This is normal.

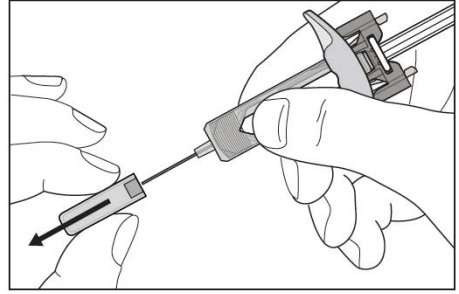

**Figure G:** pull the needle cap off

- Gently pinch the skin at the injection site (see **Figure H**).
- Insert the needle into your skin as shown.
- Push the needle all the way in to ensure that the medicine can be fully given.

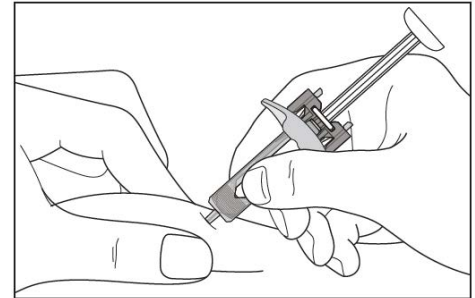

**Figure H:** insert the needle

- Hold the single-dose pre-filled syringe as shown (see **Figure I**).
- Slowly press down on the plunger as far as it will go, so that the plunger head is completely between the needle guard wings.
- Continue to press fully on the plunger while you hold the syringe in place for 5 seconds.

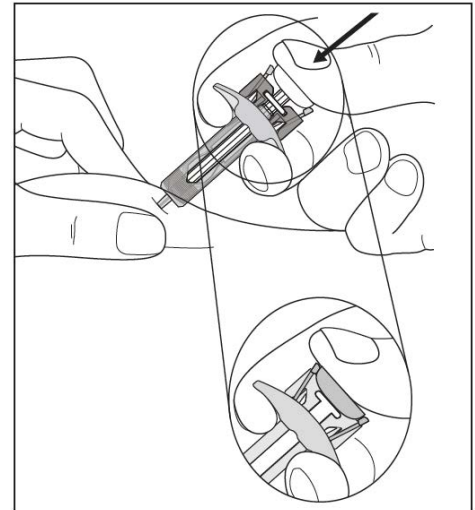

**Figure I:** hold the syringe

- **Keep the plunger fully pressed down** while you carefully lift the needle straight out from the injection site and let go of your skin (see **Figure J**).

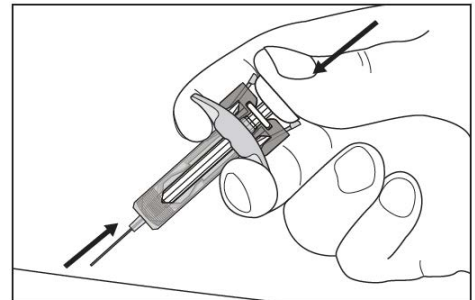

**Figure J:** lift the needle straight out

- Slowly release the plunger and allow the needle safety guard to automatically cover the exposed needle (see **Figure K**).
- There may be a small amount of blood at the injection site. You can press a cotton ball or gauze onto the injection site and hold it for 10 seconds. Do not rub the injection site. You may cover the injection site with a small adhesive bandage, if needed.

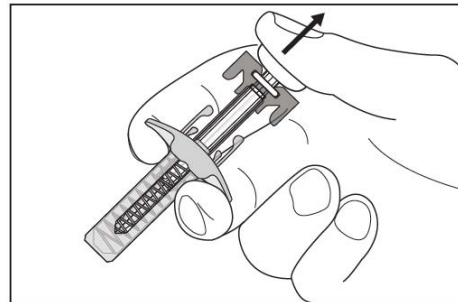

**Figure K:** slowly release the plunger

#### 4. Disposing of used pre-filled syringes

- Put your used pre-filled syringe in a FDA-cleared sharps disposal container right away after use (see **Figure J**). Do not throw away (dispose of) any pre-filled syringes in your household trash.
- If you do not have an FDA-cleared sharps disposal container, you may use a household container that is:
  - made of a heavy-duty plastic,
  - can be closed with a tight-fitting, puncture-resistant lid, without sharps being able to come out,
  - upright and stable during use,
  - leak resistant, and
  - properly labeled to warn of hazardous waste inside the container.
- When your sharps container is almost full, you will need to follow your community guidelines, for the right way to dispose of your sharps disposal container. There may be a state or local laws about how you should throw away used syringes, needles and pre-filled syringe. For more information about safe sharps disposal, and for specific information about sharps disposal, in the state that you live in, go to FDA's website at:

**[www.fda.gov/safesharpsdisposal](http://www.fda.gov/safesharpsdisposal)**

- Do not dispose your used sharps disposal container in your household trash unless your community guidelines permit this. Do not recycle your used sharps disposal container.



**Figure J:** dispose of your used pre-filled syringe

**SANDOZ** A Novartis  
Division

**Manufactured by:**

Sandoz Inc.  
Princeton, NJ 08540  
US License No. 2003

Made in Austria & U.S.A.

This Instructions for Use has been approved by the U.S. Food and Drug Administration  
10/2018

Issued:

## INSTRUCTIONS FOR USE

HYRIMOZ™ (hye-RI-moze)

(adalimumab-adaz)

Single-dose pre-filled Sensoready® Pen

injection, for subcutaneous use

To help avoid possible infections and to ensure that you use HYRIMOZ correctly, it is important that you follow these instructions.

Be sure that you read, understand, and follow this Instructions for Use before injecting HYRIMOZ. Your doctor should show you how to prepare and inject HYRIMOZ properly using the HYRIMOZ single-dose pre-filled Sensoready® Pen before you use it for the first time. Talk to your doctor if you have any questions.

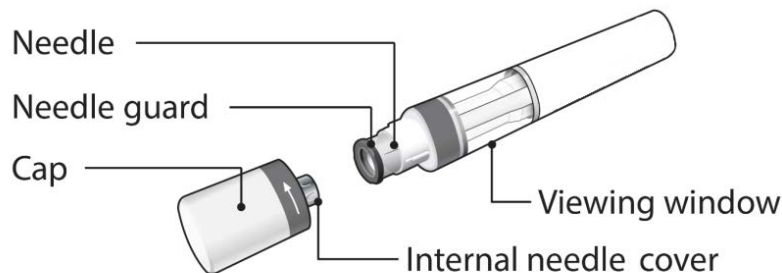

**Figure A:** HYRIMOZ Sensoready Pen parts

In Figure A, the Sensoready Pen is shown with the cap removed. **Do not remove** the cap until you are ready to inject.

### It is important that you:

- **do not use** the Sensoready Pen if either the seal on the outer carton or the safety seal on the Pen is broken.
- Keep your Sensoready Pen in the sealed outer carton until you are ready to use it.
- **do not shake** your Sensoready Pen.
- **do not handle your Sensoready Pen if you are sensitive to latex. The cap of your Sensoready Pen contains latex.**
- **do not use** your Sensoready Pen, if you dropped it, it looks damaged, or if you dropped it with the cap removed.
- **inject** HYRIMOZ 15 to 30 minutes after taking it out of the refrigerator for a more comfortable injection.
- throw away (dispose of) the used Sensoready Pen right away after use. **Do not reuse a Sensoready Pen.** See “8. Disposing of used Sensoready Pens” at the end of this Instructions for Use.

### How should you store your Sensoready Pen?

- Store your Sensoready Pen carton in a refrigerator between 36°F to 46°F (2°C to 8°C).
- If needed, for example if you are traveling, you may store your Sensoready Pen at room temperature at up to 77°F (25°C) for up to 14 days.
- Throw away any Sensoready Pen that has been stored at room temperature after 14 days.
- Record the date you first remove HYRIMOZ from the refrigerator in the spaces provided on the carton.
- Keep your Sensoready Pen in the original carton until ready to use to protect from light.
- Do not store your Sensoready Pen in extreme heat or cold.
- Do not freeze your Sensoready Pen.
- Do not drop or crush HYRIMOZ. Your Sensoready Pen contains glass.

**Keep HYRIMOZ and all medicines out of the reach of children.**

### What do you need for your injection?

Included in your Sensoready Pen carton are:

- HYRIMOZ pre-filled Sensoready Pens (see **Figure A**). Each Sensoready Pen contains 40 mg/0.8 mL of adalimumab-adaz.

Not included in your Sensoready Pen carton are:

- Alcohol wipe
- Cotton ball or gauze
- Sharps disposal container See “**8. Disposing of used Sensoready Pens**” at the end of this Instructions for Use.
- Adhesive bandage

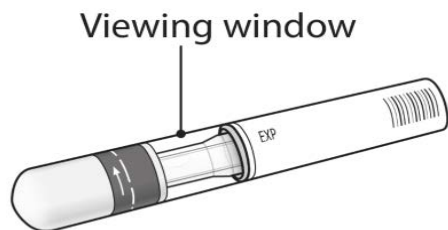

**Figure B:** items **not** included in the carton

## Before your injection

### Preparing the Sensoready Pen

- For a more comfortable injection, take your Sensoready pen out of the refrigerator 15 to 30 minutes before injecting HYRIMOZ to allow it to reach room temperature.
- Look through the viewing window. The solution should be clear, colorless to slightly yellow. Do not use your Sensoready Pen if the solution is cloudy, discolored, or has flakes or particles in it. You may see small air bubbles, which is normal. If you are not sure what color the solution should be, then contact your pharmacist for help.
- Look at the expiration date (EXP) on your Sensoready Pen (see Figure C). Do not use your Sensoready Pen if the expiration date has passed.
- Do not use if the safety seal has been broken



**Figure C:** safety checks before injection

Contact your pharmacist if:

- you are unsure about the color of the solution in the Sensoready Pen.
- the safety seal of your Sensoready Pen is broken.
- the expiration date has passed.

## 1. Choosing your injection site

- The recommended injection site is the front of your thighs. You may also use the lower abdomen, but not the area 2 inches (5 cm) around your navel (belly button) (see **Figure D**).
- Choose a different site each time you give yourself an injection.
- **Do not** inject into areas where the skin is tender, bruised, red, scaly, or hard. Avoid areas with scars or stretch marks.
- If you have psoriasis, you should **not** inject directly into areas with psoriasis plaques.

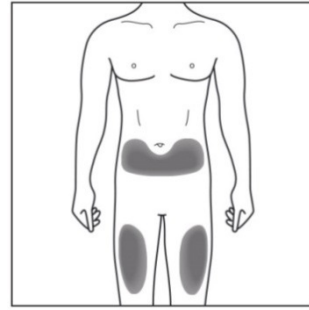

**Figure D:** choose your injection site

## 2. Cleaning your injection site

- Wash your hands well with soap and water.
- Using a circular motion, clean the injection site with an alcohol wipe. Let it dry before injecting (see **Figure E**).
- **Do not** touch the cleaned area again before injecting.

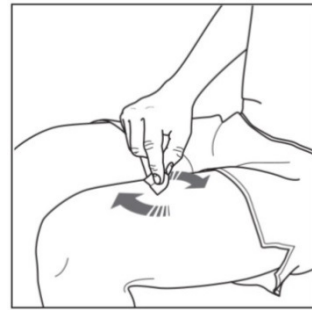

**Figure E:** clean your injection site

## 3. Removing the cap of your Sensoready Pen

- Only remove the cap when you are ready to use the Sensoready Pen.
- Twist off the cap in the direction of the arrows (see **Figure F**).
- After removed, throw away the cap. **Do not** try to re-attach the cap.
- Use your Sensoready Pen within 5 minutes of removing the cap.
- You may see a few drops of medicine come out of the needle. This is normal.

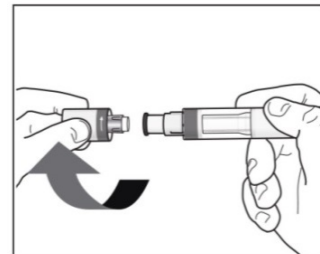

**Figure F:** remove the cap

#### 4. Holding your Sensoready Pen

- Hold your Sensoready Pen at 90 degrees to the cleaned injection site (see **Figure G**).

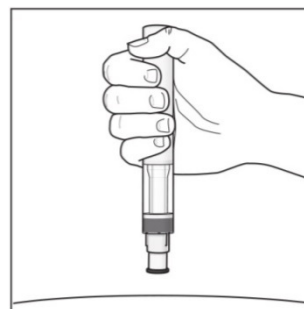
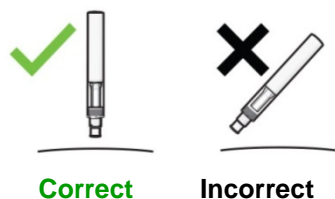

**Figure G:** hold your pen

#### Your injection

##### You must read this before injecting

During the injection you will hear **2 loud clicks**:

- The **first click** indicates that the injection has **started**.
- Several seconds later a **second click** will indicate that the injection is **almost** finished.

You **must** keep holding your Sensoready® Pen firmly against your skin until you see a **green indicator** fill the window and stop moving.

#### 5. Starting your injection

- Press your Sensoready Pen firmly against the skin to start the injection (see **Figure H**).
- The first click indicates the injection has started.
- Keep holding your Sensoready Pen firmly against your skin.
- The green indicator shows the progress of the injection.

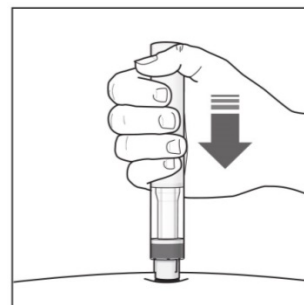

**Figure H:** start your injection

#### 6. Completing your injection

- Listen for the second click. This indicates the injection is almost complete.
- Check that the green indicator fills the window and has stopped moving (see **Figure I**).
- The Sensoready Pen can now be removed.

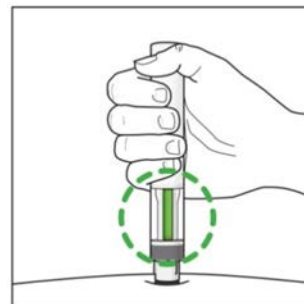
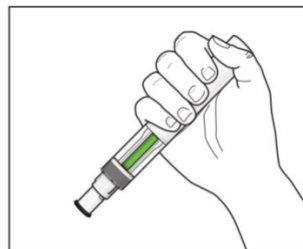

**Figure I:** complete your injection

## After your injection

### 7. Check that the green indicator fills the window (see **Figure J**)

- This means the medicine has been delivered. Contact your doctor if the green indicator is not visible.
- There may be a small amount of blood at the injection site. You can press a cotton ball or gauze over the injection site and hold it for 10 seconds. Do not rub the injection site. You may cover the injection site with a small adhesive bandage, if needed.



**Figure J:** check the green indicator

### 8. Disposing of used Sensoready® Pens

- Put your used Sensoready Pen in a FDA-cleared sharps disposal container right away after use (see **Figure K**). Do not throw away (dispose of) any Sensoready Pens in your household trash.
- If you do not have an FDA-cleared sharps disposal container, you may use a household container that is:
  - made of a heavy-duty plastic,
  - can be closed with a tight-fitting, puncture-resistant lid, without sharps being able to come out,
  - upright and stable during use,
  - leak resistant, and
  - properly labeled to warn of hazardous waste inside the container.
- When your sharps container is almost full, you will need to follow your community guidelines, for the right way to dispose of your sharps disposal container. There may be state or local laws about how you should throw away used syringes, needles and pens. For more information about safe sharps disposal, and for specific information about sharps disposal, in the state that you live in, go to FDA's website at:  
**[www.fda.gov/safesharpsdisposal](http://www.fda.gov/safesharpsdisposal)**
- Do not dispose your used sharps disposal container in your household trash unless your community guidelines permit this. Do not recycle your used sharps disposal container.

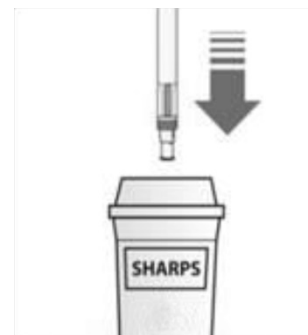

**Figure K:** dispose of your used pen

**SANDOZ** A Novartis  
Division

#### Manufactured by:

Sandoz Inc.

Princeton, NJ 08540

US License No. 2003

Made in Austria & U.S.A.

This Instructions for Use has been approved by the U.S. Food and Drug Administration  
10/2018

Issued: