

HIGHLIGHTS OF PRESCRIBING INFORMATION

These highlights do not include all the information needed to use OTULFI safely and effectively. See full prescribing information for OTULFI.

OTULFI (ustekinumab-aauz) injection, for subcutaneous or intravenous use

Initial U.S. Approval: 2024

OTULFI (ustekinumab-aauz) is biosimilar* to STELARA® (ustekinumab).

RECENT MAJOR CHANGES

Dosage and Administration (2.1, 2.2, 2.4) 03/2025

INDICATIONS AND USAGE

OTULFI is a human interleukin-12 and -23 antagonist indicated for the treatment of:

Adult patients with:

- moderate to severe plaque psoriasis (PsO) who are candidates for phototherapy or systemic therapy. (1.1)
- active psoriatic arthritis (PsA). (1.2)
- moderately to severely active Crohn's disease (CD). (1.3)
- moderately to severely active ulcerative colitis. (1.4)

Pediatric patients 6 years and older with:

- moderate to severe plaque psoriasis, who are candidates for phototherapy or systemic therapy. (1.1)
- active psoriatic arthritis (PsA). (1.2)

DOSAGE AND ADMINISTRATION

Psoriasis Adult Subcutaneous Recommended Dosage (2.1):

Weight Range (kilograms)	Recommended Dosage
less than or equal to 100 kg	45 mg administered subcutaneously initially and 4 weeks later, followed by 45 mg administered subcutaneously every 12 weeks
greater than 100 kg	90 mg administered subcutaneously initially and 4 weeks later, followed by 90 mg administered subcutaneously every 12 weeks

Psoriasis Pediatric Patients (6 to 17 years old) Subcutaneous Recommended Dosage (2.1): Weight-based dosing is recommended at the initial dose, 4 weeks later, then every 12 weeks thereafter.

Weight Range (kilograms)	Dose
less than 60 kg	0.75 mg/kg
60 kg to 100 kg	45 mg
greater than 100 kg	90 mg

Psoriatic Arthritis Adult Subcutaneous Recommended Dosage (2.2):

- The recommended dosage is 45 mg administered subcutaneously initially and 4 weeks later, followed by 45 mg administered subcutaneously every 12 weeks.
- For patients with co-existent moderate-to-severe plaque psoriasis weighing greater than 100 kg, the recommended dosage is 90 mg administered subcutaneously initially and 4 weeks later, followed by 90 mg administered subcutaneously every 12 weeks.

Psoriatic Arthritis Pediatric (6 to 17 years old) Subcutaneous Recommended Dosage (2.2): Weight-based dosing is recommended at the initial dose, 4 weeks later, then every 12 weeks thereafter.

Weight Range (kilograms)	Dose
less than 60 kg	0.75 mg/kg
60 kg or more	45 mg
greater than 100 kg with co-existent moderate-to-severe plaque psoriasis	90 mg

Crohn's Disease and Ulcerative Colitis Initial Adult Intravenous Recommended Dosage (2.3): A single intravenous infusion using weight-based dosing:

Weight Range (kilograms)	Dose
up to 55 kg	260 mg (2 vials)
greater than 55 kg to 85 kg	390 mg (3 vials)
greater than 85 kg	520 mg (4 vials)

Crohn's Disease and Ulcerative Colitis Maintenance Adult Subcutaneous Recommended Dosage (2.3): A subcutaneous 90 mg dose 8 weeks after the initial intravenous dose, then every 8 weeks thereafter.

DOSAGE FORMS AND STRENGTHS

Subcutaneous Injection (3)

- Injection: 45 mg/0.5 mL or 90 mg/mL solution in a single-dose prefilled syringe
- Injection: 45 mg/0.5 mL solution in a single-dose vial

Intravenous Infusion (3)

- Injection: 130 mg/26 mL (5 mg/mL) solution in a single-dose vial (3)

CONTRAINDICATIONS

Clinically significant hypersensitivity to ustekinumab products or to any of the excipients in OTULFI. (4)

WARNINGS AND PRECAUTIONS

- **Infections:** Serious infections have occurred. Avoid starting OTULFI during any clinically important active infection. If a serious infection or clinically significant infection develops, discontinue OTULFI until the infection resolves. (5.1)
- **Theoretical Risk for Particular Infections:** Serious infections from mycobacteria, salmonella and Bacillus Calmette-Guerin (BCG) vaccinations have been reported in patients genetically deficient in IL-12/IL-23. Consider diagnostic tests for these infections as dictated by clinical circumstances. (5.2)
- **Tuberculosis (TB):** Evaluate patients for TB prior to initiating treatment with OTULFI. Initiate treatment of latent TB before administering OTULFI. (5.3)
- **Malignancies:** Ustekinumab products may increase risk of malignancy. The safety of ustekinumab products in patients with a history of or a known malignancy has not been evaluated. (5.4)
- **Hypersensitivity Reactions:** If an anaphylactic or other clinically significant hypersensitivity reaction occurs, institute appropriate therapy and discontinue OTULFI. (5.5)
- **Posterior Reversible Encephalopathy Syndrome (PRES):** If PRES is suspected, treat promptly and discontinue OTULFI. (5.6)
- **Immunizations:** Avoid use of live vaccines in patients during treatment with OTULFI. (5.7)
- **Noninfectious Pneumonia:** Cases of interstitial pneumonia, eosinophilic pneumonia and cryptogenic organizing pneumonia have been reported during post-approval use of ustekinumab products. If diagnosis is confirmed, discontinue OTULFI and institute appropriate treatment. (5.8)

ADVERSE REACTIONS

Most common adverse reactions are:

- **Psoriasis ($\geq 3\%$):** nasopharyngitis, upper respiratory tract infection, headache, and fatigue. (6.1)
- **Crohn's Disease, induction ($\geq 3\%$):** vomiting. (6.1)
- **Crohn's Disease, maintenance ($\geq 3\%$):** nasopharyngitis, injection site erythema, vulvovaginal candidiasis/mycotic infection, bronchitis, pruritus, urinary tract infection, and sinusitis. (6.1)
- **Ulcerative colitis, induction ($\geq 3\%$):** nasopharyngitis (6.1)
- **Ulcerative colitis, maintenance ($\geq 3\%$):** nasopharyngitis, headache, abdominal pain, influenza, fever, diarrhea, sinusitis, fatigue, and nausea (6.1)

To report SUSPECTED ADVERSE REACTIONS, contact Fresenius Kabi USA, LLC at 1-800-551-7176, or FDA at 1-800-FDA-1088 or www.fda.gov/medwatch.

See 17 for PATIENT COUNSELING INFORMATION and Medication Guide.

*Biosimilar means that the biological product is approved based on data demonstrating that it is highly similar to an FDA-approved biological product, known as a reference product, and that there are no clinically meaningful differences between the biosimilar product and the reference product. Biosimilarity of OTULFI has been demonstrated for the condition(s) of use (e.g., indication(s), dosing regimen(s)), strength(s), dosage form(s), and route(s) of administration described in its Full Prescribing Information.

Revised: 03/2025

FULL PRESCRIBING INFORMATION: CONTENTS***1 INDICATIONS AND USAGE**

- 1.1 Plaque Psoriasis (PsO)
- 1.2 Psoriatic Arthritis (PsA)
- 1.3 Crohn's Disease (CD)
- 1.4 Ulcerative Colitis

2 DOSAGE AND ADMINISTRATION

- 2.1 Recommended Dosage in Plaque Psoriasis
- 2.2 Recommended Dosage in Psoriatic Arthritis
- 2.3 Recommended Dosage in Crohn's Disease and Ulcerative Colitis
- 2.4 General Considerations for Administration
- 2.5 Instructions for Administration of OTULFI Prefilled Syringes Equipped with Needle Safety Guard
- 2.6 Preparation and Administration of OTULFI 130 mg/26 mL (5 mg/mL) Vial for Intravenous Infusion (Crohn's Disease and Ulcerative Colitis)

3 DOSAGE FORMS AND STRENGTHS**4 CONTRAINDICATIONS****5 WARNINGS AND PRECAUTIONS**

- 5.1 Infections
- 5.2 Theoretical Risk for Vulnerability to Particular Infections
- 5.3 Pre-treatment Evaluation for Tuberculosis
- 5.4 Malignancies
- 5.5 Hypersensitivity Reactions
- 5.6 Posterior Reversible Encephalopathy Syndrome (PRES)
- 5.7 Immunizations
- 5.8 Noninfectious Pneumonia

6 ADVERSE REACTIONS

- 6.1 Clinical Trials Experience

- 6.2 Immunogenicity
- 6.3 Postmarketing Experience

7 DRUG INTERACTIONS

- 7.1 Concomitant Therapies
- 7.2 CYP450 Substrates
- 7.3 Allergen Immunotherapy

8 USE IN SPECIFIC POPULATIONS

- 8.1 Pregnancy
- 8.2 Lactation
- 8.4 Pediatric Use
- 8.5 Geriatric Use

10 OVERDOSAGE**11 DESCRIPTION****12 CLINICAL PHARMACOLOGY**

- 12.1 Mechanism of Action
- 12.2 Pharmacodynamics
- 12.3 Pharmacokinetics

13 NONCLINICAL TOXICOLOGY

- 13.1 Carcinogenesis, Mutagenesis, Impairment of Fertility
- 13.2 Animal Toxicology and/or Pharmacology

14 CLINICAL STUDIES

- 14.1 Adult Plaque Psoriasis
- 14.2 Pediatric Plaque Psoriasis
- 14.3 Psoriatic Arthritis
- 14.4 Crohn's Disease
- 14.5 Ulcerative Colitis

15 REFERENCES**16 HOW SUPPLIED/STORAGE AND HANDLING****17 PATIENT COUNSELING INFORMATION**

*Sections or subsections omitted from the full prescribing information are not listed.

FULL PRESCRIBING INFORMATION

1 INDICATIONS AND USAGE

1.1 Plaque Psoriasis (PsO)

OTULFI is indicated for the treatment of adults and pediatric patients 6 years of age and older with moderate to severe plaque psoriasis who are candidates for phototherapy or systemic therapy.

1.2 Psoriatic Arthritis (PsA)

OTULFI is indicated for the treatment of adults and pediatric patients 6 years of age and older with active psoriatic arthritis.

1.3 Crohn's Disease (CD)

OTULFI is indicated for the treatment of adult patients with moderately to severely active Crohn's disease.

1.4 Ulcerative Colitis

OTULFI is indicated for the treatment of adult patients with moderately to severely active ulcerative colitis.

2 DOSAGE AND ADMINISTRATION

2.1 Recommended Dosage in Plaque Psoriasis

Subcutaneous Adult Dosage Regimen

- For patients weighing 100 kg or less, the recommended dosage is 45 mg initially and 4 weeks later, followed by 45 mg every 12 weeks.
- For patients weighing more than 100 kg, the recommended dosage is 90 mg initially and 4 weeks later, followed by 90 mg every 12 weeks.

In subjects weighing more than 100 kg, 45 mg was also shown to be efficacious. However, 90 mg resulted in greater efficacy in these subjects [*see Clinical Studies (14)*].

Subcutaneous Pediatric Dosage Regimen

Administer OTULFI subcutaneously at Weeks 0 and 4, then every 12 weeks thereafter.

The recommended dose of OTULFI for pediatric patients (6-17 years old) with plaque psoriasis based on body weight is shown below (Table 1).

Table 1: Recommended Dose of OTULFI for Subcutaneous Injection in Pediatric Patients (6- 17 years old) with Plaque Psoriasis

Body Weight of Patient at the Time of Dosing	Recommended Dose
less than 60 kg	0.75 mg/kg
60 kg to 100 kg	45 mg
more than 100 kg	90 mg

For pediatric patients weighing less than 60 kg, the administration volume for the recommended dose (0.75 mg/kg) is shown in Table 2; withdraw the appropriate volume from the single-dose vial.

Table 2: Injection volumes of OTULFI 45 mg/0.5 mL single-dose vials for pediatric patients (6- 17 years old) with plaque psoriasis and pediatric patients (6-17 years old) with psoriatic arthritis* weighing less than 60 kg

Body Weight (kg) at the time of dosing	Dose (mg)	Volume of injection (mL)
15	11.3	0.12
16	12.0	0.13
17	12.8	0.14
18	13.5	0.15
19	14.3	0.16
20	15.0	0.17
21	15.8	0.17
22	16.5	0.18
23	17.3	0.19
24	18.0	0.20
25	18.8	0.21
26	19.5	0.22
27	20.3	0.22
28	21.0	0.23
29	21.8	0.24
30	22.5	0.25
31	23.3	0.26
32	24	0.27
33	24.8	0.27
34	25.5	0.28
35	26.3	0.29
36	27	0.3
37	27.8	0.31
38	28.5	0.32
39	29.3	0.32
40	30	0.33
41	30.8	0.34
42	31.5	0.35
43	32.3	0.36
44	33	0.37
45	33.8	0.37
46	34.5	0.38
47	35.3	0.39
48	36	0.4
49	36.8	0.41
50	37.5	0.42
51	38.3	0.42
52	39	0.43
53	39.8	0.44
54	40.5	0.45

55	41.3	0.46
56	42	0.46
57	42.8	0.47
58	43.5	0.48
59	44.3	0.49

* Refer to 2.2 Psoriatic Arthritis; Subcutaneous Pediatric Dosage Regimen.

2.2 Recommended Dosage in Psoriatic Arthritis

Subcutaneous Adult Dosage Regimen

- The recommended dosage is 45 mg initially and 4 weeks later, followed by 45 mg every 12 weeks.
- For patients with co-existent moderate-to-severe plaque psoriasis weighing more than 100 kg, the recommended dosage is 90 mg initially and 4 weeks later, followed by 90 mg every 12 weeks.

Subcutaneous Pediatric Dosage Regimen

Administer OTULFI subcutaneously at Weeks 0 and 4, then every 12 weeks thereafter.

The recommended dose of OTULFI for pediatric patients (6 to 17 years old) with psoriatic arthritis, based on body weight, is shown below (Table 3).

Table 3: Recommended Dose of OTULFI for Subcutaneous Injection in Pediatric Patients (6 to 17 years old) with Psoriatic Arthritis

Body Weight of Patient at the Time of Dosing	Recommended Dose
less than 60 kg*	0.75 mg/kg
60 kg or more	45 mg
greater than 100 kg with co-existent moderate-to-severe plaque psoriasis	90 mg

* For pediatric patients weighing less than 60 kg, the administration volume for the recommended dose (0.75 mg/kg) is shown in Table 2; withdraw the appropriate volume from the single-dose vial.

2.3 Recommended Dosage in Crohn's Disease and Ulcerative Colitis

Intravenous Induction Adult Dosage Regimen

A single intravenous infusion dose of OTULFI using the weight-based dosage regimen specified in Table 4 [see *Instructions for dilution of OTULFI 130 mg vial for intravenous infusion (2.6)*].

Table 4: Initial Intravenous Dosage of OTULFI

Body Weight of Patient at the time of dosing	Dose	Number of 130 mg/26 mL (5 mg/mL) OTULFI vials
55 kg or less	260 mg	2
more than 55 kg to 85 kg	390 mg	3
more than 85 kg	520 mg	4

Subcutaneous Maintenance Adult Dosage Regimen

The recommended maintenance dosage is a subcutaneous 90 mg dose administered 8 weeks after the initial intravenous dose, then every 8 weeks thereafter.

2.4 General Considerations for Administration

- OTULFI is intended for use under the guidance and supervision of a healthcare provider. OTULFI should only be administered to patients who will be closely monitored and have regular follow-up visits with a healthcare provider. The appropriate dose should be determined by a healthcare provider using the patient's current weight at the time of dosing. In pediatric patients, it is recommended that OTULFI be administered by a healthcare provider. If a healthcare provider determines that it is appropriate, a patient may self-inject or a caregiver may inject OTULFI after proper training in subcutaneous injection technique. Instruct patients to follow the directions provided in the Medication Guide [*see Medication Guide*].
- The needle cover on the prefilled syringe is not made with natural rubber (a derivative of latex).
- It is recommended that each injection be administered at a different anatomic location (such as upper arms, gluteal regions, thighs, or any quadrant of abdomen) than the previous injection, and not into areas where the skin is tender, bruised, erythematous, or indurated. When using the single-dose vial, a 1 mL syringe with a 27 gauge, ½ inch needle is recommended.
- Prior to administration, visually inspect OTULFI for particulate matter and discoloration. OTULFI is a clear to slightly opalescent and colorless to slightly brown-yellow solution. Do not use OTULFI if it is discolored or cloudy, or if other particulate matter is present. OTULFI does not contain preservatives; therefore, discard any unused product remaining in the vial and/or syringe.

2.5 Instructions for Administration of OTULFI Prefilled Syringes Equipped with Needle Safety Guard

Refer to the diagram below for the provided instructions.

To prevent premature activation of the needle safety guard, do not touch the NEEDLE GUARD ACTIVATION CLIPS at any time during use.

Product before administration

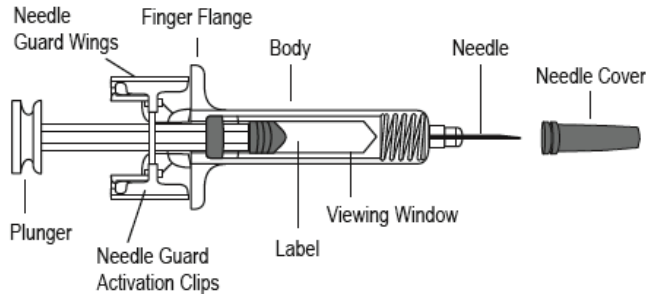

Product after administration –
Guard is released and covers the needle

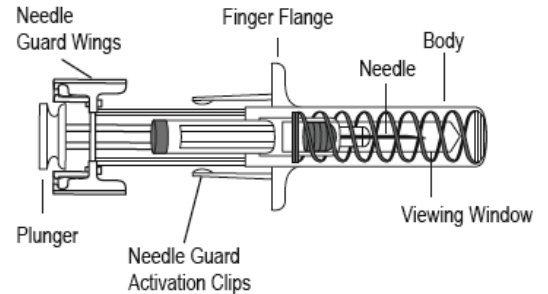

- Hold the BODY and remove the NEEDLE COVER. **Do not hold the PLUNGER or PLUNGER HEAD while removing the NEEDLE COVER or the PLUNGER may move. Do not use the prefilled syringe if it is dropped without the NEEDLE COVER in place. Do not use the prefilled syringe if it is dropped or if it is dropped onto a hard surface.**
- Inject OTULFI subcutaneously as recommended [see *Dosage and Administration (2.1, 2.2, 2.3)*].
- Inject all of the medication by pushing in the PLUNGER until the PLUNGER HEAD is completely between the needle guard wings. **Injection of the entire prefilled syringe contents is necessary to activate the needle guard.**

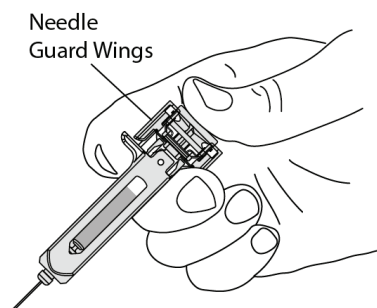

- After injection, maintain the pressure on the PLUNGER HEAD and remove the needle from the skin. Slowly take your thumb off the PLUNGER HEAD to allow the empty

syringe to move up until the entire needle is covered by the needle guard, as shown by the illustration below:

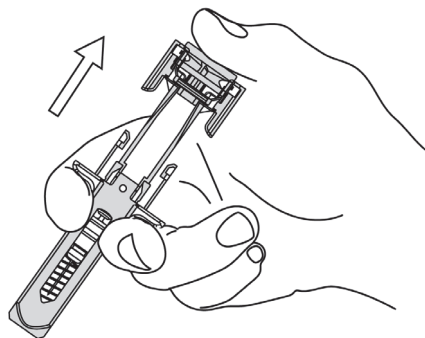

- Used syringes should be placed in a puncture-resistant container.

2.6 Preparation and Administration of OTULFI 130 mg/26 mL (5 mg/mL) Vial for Intravenous Infusion (Crohn's Disease and Ulcerative Colitis)

OTULFI solution for intravenous infusion must be diluted, prepared and infused by a healthcare professional using aseptic technique.

1. Calculate the dose and the number of OTULFI vials needed based on patient weight (Table 4). Each 26 mL vial of OTULFI contains 130 mg of ustekinumab-aauz.
2. Withdraw, and then discard a volume of the 0.9% Sodium Chloride Injection, USP from the 250 mL infusion bag equal to the volume of OTULFI to be added (discard 26 mL sodium chloride for each vial of OTULFI needed, for 2 vials- discard 52 mL, for 3 vials- discard 78 mL, 4 vials- discard 104 mL). Alternatively, a 250 mL infusion bag containing 0.45% Sodium Chloride Injection, USP may be used.
3. Withdraw 26 mL of OTULFI from each vial needed and add it to the 250 mL infusion bag. The final volume in the infusion bag should be 250 mL. Gently mix.
4. Visually inspect the diluted solution before infusion. Do not use if visibly opaque particles, discoloration or foreign particles are observed.
5. Infuse the diluted solution over a period of at least one hour. Once diluted, the infusion should be completely administered within eight hours of the dilution in the infusion bag.
6. Use only polypropylene (PP) or polyvinylchloride (PVC) infusion sets with an in-line, sterile, non-pyrogenic, low protein-binding filter (pore size 0.2 micrometer).
7. Do not infuse OTULFI concomitantly in the same intravenous line with other agents.
8. OTULFI does not contain preservatives. Each vial is for one-time use in only one patient. Discard any remaining solution. Dispose any unused medicinal product in accordance with local requirements.

Storage

If necessary, the diluted infusion solution may be kept at room temperature up to 25°C (77°F) for up to 7 hours. Storage time at room temperature begins once the diluted solution has been prepared. The infusion should be completed within 8 hours after the dilution in the infusion bag (cumulative time after preparation including the storage and the infusion period). Do not freeze. Discard any unused portion of the infusion solution. Protect from light.

3 DOSAGE FORMS AND STRENGTHS

OTULFI (ustekinumab-aauz) is a clear to slightly opalescent and colorless to slightly brown-yellow solution.

Subcutaneous Injection

- Injection: 45 mg/0.5 mL or 90 mg/mL solution in a single-dose prefilled syringe
- Injection: 45 mg/0.5 mL solution in a single-dose vial

Intravenous Infusion

- Injection: 130 mg/26 mL (5 mg/mL) solution in a single-dose vial

4 CONTRAINDICATIONS

OTULFI is contraindicated in patients with clinically significant hypersensitivity to ustekinumab products or to any of the excipients in OTULFI [see *Warnings and Precautions (5.5)*].

5 WARNINGS AND PRECAUTIONS

5.1 Infections

Ustekinumab products may increase the risk of infections and reactivation of latent infections. Serious bacterial, mycobacterial, fungal, and viral infections were observed in patients receiving ustekinumab products [see *Adverse Reactions (6.1, 6.3)*].

Serious infections requiring hospitalization, or otherwise clinically significant infections, reported in clinical trials included the following:

- *Plaque Psoriasis*: diverticulitis, cellulitis, pneumonia, appendicitis, cholecystitis, sepsis, osteomyelitis, viral infections, gastroenteritis and urinary tract infections.
- *Psoriatic arthritis*: cholecystitis.
- *Crohn's disease*: anal abscess, gastroenteritis, ophthalmic herpes zoster, pneumonia, and listeria meningitis.
- *Ulcerative colitis*: gastroenteritis, ophthalmic herpes zoster, pneumonia, and listeriosis.

Avoid initiating treatment with OTULFI in patients with any clinically important active infection until the infection resolves or is adequately treated. Consider the risks and benefits of treatment prior to initiating use of OTULFI in patients with a chronic infection or a history of recurrent infection.

Instruct patients to seek medical advice if signs or symptoms suggestive of an infection occur while on treatment with OTULFI and discontinue OTULFI for serious or clinically significant infections until the infection resolves or is adequately treated.

5.2 Theoretical Risk for Vulnerability to Particular Infections

Individuals genetically deficient in IL-12/IL-23 are particularly vulnerable to disseminated

infections from mycobacteria (including nontuberculous, environmental mycobacteria), salmonella (including nontyphi strains), and Bacillus Calmette-Guerin (BCG) vaccinations. Serious infections and fatal outcomes have been reported in such patients.

It is not known whether patients with pharmacologic blockade of IL-12/IL-23 from treatment with ustekinumab products may be susceptible to these types of infections. Consider appropriate diagnostic testing (e.g., tissue culture, stool culture, as dictated by clinical circumstances).

5.3 Pre-treatment Evaluation for Tuberculosis

Evaluate patients for tuberculosis infection prior to initiating treatment with OTULFI.

Avoid administering OTULFI to patients with active tuberculosis infection. Initiate treatment of latent tuberculosis prior to administering OTULFI. Consider anti-tuberculosis therapy prior to initiation of OTULFI in patients with a past history of latent or active tuberculosis in whom an adequate course of treatment cannot be confirmed. Closely monitor patients receiving OTULFI for signs and symptoms of active tuberculosis during and after treatment.

5.4 Malignancies

Ustekinumab products are immunosuppressants and may increase the risk of malignancy. Malignancies were reported among subjects who received ustekinumab in clinical trials [see *Adverse Reactions (6.1)*]. In rodent models, inhibition of IL-12/IL-23p40 increased the risk of malignancy [see *Nonclinical Toxicology (13)*].

The safety of ustekinumab products has not been evaluated in patients who have a history of malignancy or who have a known malignancy.

There have been post-marketing reports of the rapid appearance of multiple cutaneous squamous cell carcinomas in patients receiving ustekinumab products who had pre-existing risk factors for developing non-melanoma skin cancer. Monitor all patients receiving OTULFI for the appearance of non-melanoma skin cancer. Closely follow patients greater than 60 years of age, those with a medical history of prolonged immunosuppressant therapy and those with a history of PUVA treatment [see *Adverse Reactions (6.1)*].

5.5 Hypersensitivity Reactions

Hypersensitivity reactions, including anaphylaxis and angioedema, have been reported with ustekinumab products [see *Adverse Reactions (6.1, 6.3)*]. If an anaphylactic or other clinically significant hypersensitivity reaction occurs, institute appropriate therapy and discontinue OTULFI.

5.6 Posterior Reversible Encephalopathy Syndrome (PRES)

Two cases of posterior reversible encephalopathy syndrome (PRES), also known as Reversible Posterior Leukoencephalopathy Syndrome (RPLS), were reported in clinical trials. Cases have also been reported in postmarketing experience in patients with psoriasis, psoriatic arthritis and Crohn's disease. Clinical presentation included headaches, seizures, confusion, visual disturbances, and imaging changes consistent with PRES a few days to several months after ustekinumab product initiation. A few cases reported latency of a year or longer. Patients recovered with supportive care following withdrawal of ustekinumab products.

Monitor all patients treated with OTULFI for signs and symptoms of PRES. If PRES is suspected, promptly administer appropriate treatment and discontinue OTULFI.

5.7 Immunizations

Prior to initiating therapy with OTULFI, patients should receive all age-appropriate immunizations as recommended by current immunization guidelines. Patients being treated with OTULFI should avoid receiving live vaccines. Avoid administering BCG vaccines during treatment with OTULFI or for one year prior to initiating treatment or one year following discontinuation of treatment. Caution is advised when administering live vaccines to household contacts of patients receiving OTULFI because of the potential risk for shedding from the household contact and transmission to patient.

Non-live vaccinations received during a course of OTULFI may not elicit an immune response sufficient to prevent disease.

5.8 Noninfectious Pneumonia

Cases of interstitial pneumonia, eosinophilic pneumonia and cryptogenic organizing pneumonia have been reported during post-approval use of ustekinumab products. Clinical presentations included cough, dyspnea, and interstitial infiltrates following one to three doses. Serious outcomes have included respiratory failure and prolonged hospitalization. Patients improved with discontinuation of therapy and in certain cases administration of corticosteroids. If diagnosis is confirmed, discontinue OTULFI and institute appropriate treatment [see *Postmarketing Experience (6.3)*].

6 ADVERSE REACTIONS

The following serious adverse reactions are discussed elsewhere in the label:

- Infections [see *Warnings and Precautions (5.1)*]
- Malignancies [see *Warnings and Precautions (5.4)*]
- Hypersensitivity Reactions [see *Warnings and Precautions (5.5)*]
- Posterior Reversible Encephalopathy Syndrome (PRES) [see *Warnings and Precautions (5.6)*]
- Noninfectious Pneumonia [see *Warnings and Precautions (5.8)*]

6.1 Clinical Trials Experience

Because clinical trials are conducted under widely varying conditions, adverse reaction rates observed in the clinical trials of a drug cannot be directly compared to rates in the clinical trials of another drug and may not reflect the rates observed in practice.

Adult Subjects with Plaque Psoriasis

The safety data reflect exposure to ustekinumab in 3117 adult subjects with plaque psoriasis, including 2414 exposed for at least 6 months, 1855 exposed for at least one year, 1653 exposed for at least two years, 1569 exposed for at least three years, 1482 exposed for at least four years and 838 exposed for at least five years.

Table 5 summarizes the adverse reactions that occurred at a rate of at least 1% with higher rates in the ustekinumab groups during the placebo-controlled period of Ps STUDY 1 and Ps STUDY 2 [see *Clinical Studies (14)*].

Table 5: Adverse Reactions Reported by $\geq 1\%$ of Subjects with Plaque Psoriasis and at Higher Rates in the ustekinumab groups through Week 12 in Ps STUDY 1 and Ps STUDY 2

	ustekinumab		
	Placebo	45 mg	90 mg
Subjects treated	665	664	666
Nasopharyngitis	51 (8%)	56 (8%)	49 (7%)
Upper respiratory tract infection	30 (5%)	36 (5%)	28 (4%)
Headache	23 (3%)	33 (5%)	32 (5%)
Fatigue	14 (2%)	18 (3%)	17 (3%)
Back pain	8 1%	9 1%	14 (2%)
Dizziness	8 1%	8 1%	14 (2%)
Pharyngolaryngeal pain	7 1%	9 1%	12 (2%)
Pruritus	9 1%	10 (2%)	9 1%
Injection site erythema	3 <1%	6 1%	13 (2%)
Myalgia	4 1%	7 1%	8 1%
Depression	3 <1%	8 1%	4 1%

Adverse reactions that occurred at rates less than 1% in the controlled period of Ps STUDIES 1 and 2 through week 12 included: cellulitis, herpes zoster, diverticulitis and certain injection site reactions (pain, swelling, pruritus, induration, hemorrhage, bruising, and irritation).

One case of PRES occurred during adult plaque psoriasis clinical trials [see *Warnings and Precautions (5.6)*].

Infections

In the placebo-controlled period of clinical trials of subjects with plaque psoriasis (average follow-up of 12.6 weeks for placebo-treated subjects and 13.4 weeks for ustekinumab-treated subjects), 27% of ustekinumab-treated subjects reported infections (1.39 per patient-years of follow-up) compared with 24% of placebo-treated subjects (1.21 per patient-years of follow-up). Serious infections occurred in 0.3% of ustekinumab-treated subjects (0.01 per patient-years of follow-up) and in 0.4% of placebo-treated subjects (0.02 per patient-years of follow-up) [see *Warnings and Precautions (5.1)*].

In the controlled and non-controlled portions of plaque psoriasis clinical trials (median follow-up of 3.2 years), representing 8998 patient-years of exposure, 72.3% of ustekinumab-treated subjects reported infections (0.87 per patient-years of follow-up). Serious infections were reported in 2.8% of subjects (0.01 per patient-years of follow-up).

Malignancies

In the controlled and non-controlled portions of plaque psoriasis clinical trials (median follow-up of 3.2 years, representing 8998 patient-years of exposure), 1.7% of ustekinumab-treated subjects reported malignancies excluding non-melanoma skin cancers (0.60 per hundred patient-years of follow-up). Non-melanoma skin cancer was reported in 1.5% of ustekinumab-treated subjects (0.52 per hundred patient-years of follow-up) [see *Warnings and Precautions (5.4)*]. The most frequently observed malignancies other than non-melanoma skin cancer during the clinical trials were: prostate, melanoma, colorectal and breast. Malignancies other than non-melanoma skin cancer in ustekinumab-treated subjects during the controlled and uncontrolled portions of trials were similar in type and number to what would be expected in the general U.S. population according to the SEER database (adjusted for age, gender and race).¹

Pediatric Subjects with Plaque Psoriasis

The safety of ustekinumab was assessed in two trials of pediatric subjects with moderate to severe plaque psoriasis. Ps STUDY 3 evaluated safety for up to 60 weeks in 110 pediatric subjects 12 to 17 years old. Ps STUDY 4 evaluated safety for up to 56 weeks in 44 pediatric

subjects 6 to 11 years old. The safety profile in pediatric subjects was similar to the safety profile from trials in adults with plaque psoriasis.

Psoriatic Arthritis

The safety of ustekinumab was assessed in 927 subjects in two randomized, double-blind, placebo- controlled trials in adults with active psoriatic arthritis (PsA). The overall safety profile of ustekinumab in subjects with PsA was consistent with the safety profile seen in adult psoriasis clinical trials. A higher incidence of arthralgia, nausea, and dental infections was observed in ustekinumab-treated subjects when compared with placebo-treated subjects (3% vs. 1% for arthralgia and 3% vs. 1% for nausea; 1% vs. 0.6% for dental infections) in the placebo-controlled portions of the PsA clinical trials.

Crohn's Disease

The safety of ustekinumab was assessed in 1407 subjects with moderately to severely active Crohn's disease (Crohn's Disease Activity Index [CDAI] greater than or equal to 220 and less than or equal to 450) in three randomized, double-blind, placebo-controlled, parallel-group, multicenter trials. These 1407 subjects included 40 subjects who received a prior investigational intravenous ustekinumab formulation but were not included in the efficacy analyses. In trials CD-1 and CD-2 there were 470 subjects who received ustekinumab 6 mg/kg as a weight-based single intravenous induction dose and 466 who received placebo [see *Dosage and Administration (2.3)*]. Subjects who were responders in either trial CD-1 or CD-2 were randomized to receive a subcutaneous maintenance regimen of either 90 mg ustekinumab every 8 weeks, or placebo for 44 weeks in trial CD-3. Subjects in these 3 trials may have received other concomitant therapies including aminosalicylates, immunomodulatory agents [azathioprine (AZA), 6-mercaptopurine (6-MP), methotrexate (MTX)], oral corticosteroids (prednisone or budesonide), and/or antibiotics for their Crohn's disease [see *Clinical Studies (14.4)*].

The overall safety profile of ustekinumab was consistent with the safety profile seen in the adult psoriasis and psoriatic arthritis clinical trials. Common adverse reactions in trials CD-1 and CD-2 and in trial CD-3 are listed in Tables 6 and 7, respectively.

Table 6: Common adverse reactions through Week 8 in Trials CD-1 and CD-2 occurring in $\geq 3\%$ of ustekinumab-treated subjects and higher than placebo

	Placebo N=466	ustekinumab 6 mg/kg single intravenous induction dose N=470
Vomiting	3%	4%

Other less common adverse reactions reported in subjects in trials CD-1 and CD-2 included asthenia (1% vs 0.4%), acne (1% vs 0.4%), and pruritus (2% vs 0.4%).

Table 7: Common adverse reactions through Week 44 in Trial CD-3 occurring in $\geq 3\%$ of ustekinumab-treated subjects and higher than placebo

	Placebo N=133	ustekinumab 90 mg subcutaneous maintenance dose every 8 weeks N=131
Nasopharyngitis	8%	11%
Injection site erythema	0	5%

Vulvovaginal candidiasis/mycotic infection	1%	5%
Bronchitis	3%	5%
Pruritus	2%	4%
Urinary tract infection	2%	4%
Sinusitis	2%	3%

Infections

In subjects with Crohn's disease, serious or other clinically significant infections included anal abscess, gastroenteritis, and pneumonia. In addition, listeria meningitis and ophthalmic herpes zoster were reported in one patient each [see *Warnings and Precautions (5.1)*].

Malignancies

With up to one year of treatment in the Crohn's disease clinical trials, 0.2% of ustekinumab-treated subjects (0.36 events per hundred patient-years) and 0.2% of placebo-treated subjects (0.58 events per hundred patient-years) developed non-melanoma skin cancer.

Malignancies other than non-melanoma skin cancers occurred in 0.2% of ustekinumab-treated subjects (0.27 events per hundred patient-years) and in none of the placebo-treated subjects.

Hypersensitivity Reactions Including Anaphylaxis

In CD trials, two subjects reported hypersensitivity reactions following ustekinumab administration. One patient experienced signs and symptoms consistent with anaphylaxis (tightness of the throat, shortness of breath, and flushing) after a single subcutaneous administration (0.1% of subjects receiving subcutaneous ustekinumab). In addition, one subject experienced signs and symptoms consistent with or related to a hypersensitivity reaction (chest discomfort, flushing, urticaria, and increased body temperature) after the initial intravenous ustekinumab dose (0.08% of subjects receiving intravenous ustekinumab). These subjects were treated with oral antihistamines or corticosteroids and in both cases symptoms resolved within an hour.

Ulcerative Colitis

The safety of ustekinumab was evaluated in two randomized, double-blind, placebo-controlled clinical trials (UC-1 [IV induction] and UC-2 [SC maintenance]) in 960 adult subjects with moderately to severely active ulcerative colitis [see *Clinical Studies (14.5)*]. The overall safety profile of ustekinumab in subjects with ulcerative colitis was consistent with the safety profile seen across all approved indications. Adverse reactions reported in at least 3% of ustekinumab-treated subjects and at a higher rate than placebo were:

- Induction (UC-1): nasopharyngitis (7% vs 4%).
- Maintenance (UC-2): nasopharyngitis 24% vs 20%), headache 10% vs 4%), abdominal pain 7% vs 3%), influenza (6% vs 5%), fever 5% vs. 4%), diarrhea 4% vs 1%), sinusitis (4% vs 1%), fatigue (4% vs 2%), and nausea (3% vs 2%).

Infections

In subjects with ulcerative colitis, serious or other clinically significant infections included gastroenteritis and pneumonia. In addition, listeriosis and ophthalmic herpes zoster were reported in one subject each [see *Warnings and Precautions (5.1)*].

Malignancies

With up to one year of treatment in the ulcerative colitis clinical trials, 0.4% of ustekinumab-

treated subjects (0.48 events per hundred patient-years) and 0.0% of placebo-treated subjects (0.00 events per hundred patient-years) developed non-melanoma skin cancer. Malignancies other than non-melanoma skin cancers occurred in 0.5% of ustekinumab-treated subjects (0.64 events per hundred patient-years) and 0.2% of placebo-treated subjects (0.40 events per hundred patient-years).

6.2 Immunogenicity

The observed incidence of anti-drug antibodies is highly dependent on the sensitivity and specificity of the assay. Differences in assay methods preclude meaningful comparisons of the incidence of anti-drug antibodies in the studies described below with the incidence of anti-drug antibodies in other studies, including those of ustekinumab or of other ustekinumab products.

Approximately 6 to 12.4% of subjects treated with ustekinumab in plaque psoriasis and psoriatic arthritis clinical trials developed antibodies to ustekinumab, which were generally low-titer. In plaque psoriasis clinical trials, antibodies to ustekinumab were associated with reduced or undetectable serum ustekinumab concentrations and reduced efficacy. In plaque psoriasis trials, the majority of subjects who were positive for antibodies to ustekinumab had neutralizing antibodies.

In Crohn's disease and ulcerative colitis clinical trials, 2.9% and 4.6% of subjects, respectively, developed antibodies to ustekinumab when treated with ustekinumab for approximately one year. No apparent association between the development of antibodies to ustekinumab and the development of injection site reactions was seen.

6.3 Postmarketing Experience

The following adverse reactions have been reported during post-approval use of ustekinumab products. Because these reactions are reported voluntarily from a population of uncertain size, it is not always possible to reliably estimate their frequency or establish a causal relationship to ustekinumab product exposure.

Immune system disorders: Serious hypersensitivity reactions (including anaphylaxis and angioedema), other hypersensitivity reactions (including rash and urticaria).

Infections and infestations: Lower respiratory tract infection (including opportunistic fungal infections and tuberculosis).

Neurological disorders: Posterior Reversible Encephalopathy Syndrome (PRES).

Respiratory, thoracic and mediastinal disorders: Interstitial pneumonia, eosinophilic pneumonia and cryptogenic organizing pneumonia.

Skin reactions: Pustular psoriasis, erythrodermic psoriasis, hypersensitivity vasculitis.

7 DRUG INTERACTIONS

7.1 Concomitant Therapies

In plaque psoriasis trials the safety of ustekinumab products in combination with immunosuppressive agents or phototherapy has not been evaluated. In psoriatic arthritis trials, concomitant MTX use did not appear to influence the safety or efficacy of ustekinumab. In Crohn's disease and ulcerative colitis induction trials, immunomodulators (6-MP, AZA, MTX) were used concomitantly in approximately 30% of subjects and corticosteroids were used concomitantly in approximately 40% and 50% of Crohn's disease and ulcerative colitis,¹⁶

subjects, respectively. Use of these concomitant therapies did not appear to influence the overall safety or efficacy of ustekinumab.

7.2 CYP450 Substrates

The formation of CYP450 enzymes can be suppressed by increased levels of certain cytokines (e.g., IL-1, IL-6, TNF α , IFN) during chronic inflammation. Thus, use of ustekinumab products, antagonists of IL-12 and IL-23, could normalize the formation of CYP450 enzymes. Upon initiation or discontinuation of OTULFI in patients who are receiving concomitant CYP450 substrates, particularly those with a narrow therapeutic index, consider monitoring for therapeutic effect or drug concentration and adjust the individual dosage of the CYP substrates as needed. See the prescribing information of specific CYP substrates.

A CYP-mediated drug interaction effect was not observed in subjects with Crohn's disease [see *Clinical Pharmacology (12.3)*].

7.3 Allergen Immunotherapy

Ustekinumab products have not been evaluated in patients who have undergone allergy immunotherapy. Ustekinumab products may decrease the protective effect of allergen immunotherapy (decrease tolerance) which may increase the risk of an allergic reaction to a dose of allergen immunotherapy. Therefore, caution should be exercised in patients receiving or who have received allergen immunotherapy, particularly for anaphylaxis.

8 USE IN SPECIFIC POPULATIONS

8.1 Pregnancy

Risk Summary

Limited data from observational studies, published case reports, and postmarketing surveillance on the use of ustekinumab products during pregnancy are insufficient to inform a drug associated risk of major birth defects, miscarriage, and other adverse maternal or fetal outcomes. Transport of human IgG antibody across the placenta increases as pregnancy progresses and peaks during the third trimester; therefore, ustekinumab products may be transferred to the developing fetus (see *Clinical Considerations*). In animal reproductive and developmental toxicity studies, no adverse developmental effects were observed in offspring after administration of ustekinumab to pregnant monkeys at exposures greater than 100 times the maximum recommended human dose (MRHD).

The background risk of major birth defects and miscarriage for the indicated population(s) are unknown. All pregnancies have a background risk of birth defect, loss, or other adverse outcomes. In the U.S. general population, the estimated background risk of major birth defects and miscarriage of clinically recognized pregnancies is 2% to 4% and 15% to 20%, respectively.

Clinical Considerations

Fetal/Neonatal Adverse Reactions

Because ustekinumab products may theoretically interfere with immune response to infections, consider risks and benefits prior to administering live vaccines to infants exposed to OTULFI

in utero. There are insufficient data regarding exposed infant serum levels of ustekinumab products at birth and the duration of persistence of ustekinumab products in infant serum after birth. Although a specific timeframe to delay administration of live attenuated vaccines in infants exposed in utero is unknown, consider the risks and benefits of delaying a minimum of 6 months after birth because of the clearance of the product.

Data

Animal Data

Ustekinumab was tested in two embryo-fetal development toxicity studies in cynomolgus monkeys. No teratogenic or other adverse developmental effects were observed in fetuses from pregnant monkeys that were administered ustekinumab subcutaneously twice weekly or intravenously weekly during the period of organogenesis. Serum concentrations of ustekinumab in pregnant monkeys were greater than 100 times the serum concentration in patients treated subcutaneously with 90 mg of ustekinumab weekly for 4 weeks.

In a combined embryo-fetal development and pre- and post-natal development toxicity study, pregnant cynomolgus monkeys were administered subcutaneous doses of ustekinumab twice weekly at exposures greater than 100 times the MRHD from the beginning of organogenesis to Day 33 after delivery. Neonatal deaths occurred in the offspring of one monkey administered ustekinumab at 22.5 mg/kg and one monkey dosed at 45 mg/kg. No ustekinumab-related effects on functional, morphological, or immunological development were observed in the neonates from birth through six months of age.

8.2 Lactation

Risk Summary

Limited data from published literature suggests that ustekinumab is present in human breast milk. There are no available data on the effects of ustekinumab products on milk production. The effects of local gastrointestinal exposure and limited systemic exposure in the breastfed infant to ustekinumab products are unknown. No adverse effects on the breastfed infant causally related to ustekinumab products have been identified in the published literature or postmarketing experience.

The developmental and health benefits of breastfeeding should be considered along with the mother's clinical need for OTULFI and any potential adverse effects on the breastfed child from OTULFI or from the underlying maternal condition.

8.4 Pediatric Use

Plaque Psoriasis

The safety and effectiveness of OTULFI have been established for the treatment of moderate to severe plaque psoriasis in pediatric patients 6 to 17 years of age who are candidates for phototherapy or systemic therapy.

Use of OTULFI in pediatric patients 12 to less than 17 years of age is supported by evidence from a multicenter, randomized, 60-week trial (Ps STUDY 3) of ustekinumab that included a 12-week, double-blind, placebo-controlled, parallel-group portion, in 110 pediatric subjects 12 years of age and older [*see Adverse Reactions (6.1), Clinical Studies (14.2)*].

Use of OTULFI in pediatric patients 6 to 11 years of age is supported by evidence from an

open-label, single-arm, efficacy, safety and pharmacokinetics trial (Ps STUDY 4) of ustekinumab in 44 subjects [see *Adverse Reactions (6.1)*, *Pharmacokinetics (12.3)*].

The safety and effectiveness of OTULFI have not been established in pediatric patients less than 6 years of age with plaque psoriasis.

Psoriatic Arthritis

The safety and effectiveness of OTULFI have been established for treatment of psoriatic arthritis in pediatric patients 6 to 17 years old.

Use of OTULFI in these age groups is supported by evidence from adequate and well controlled trials of ustekinumab in adults with psoriasis and PsA, pharmacokinetic data from adult subjects with psoriasis, adult subjects with PsA and pediatric subjects with psoriasis, and safety data of ustekinumab from two clinical trials in 44 pediatric subjects 6 to 11 years old with psoriasis and 110 pediatric subjects 12 to 17 years old with psoriasis. The observed pre-dose (trough) concentrations are generally comparable between adult subjects with psoriasis, adult subjects with PsA and pediatric subjects with psoriasis, and the PK exposure is expected to be comparable between adult and pediatric subjects with PsA [see *Adverse Reactions (6.1)*, *Clinical Pharmacology (12.3)*, and *Clinical Studies (14.1, 14.2, 14.3)*].

The safety and effectiveness of OTULFI have not been established in pediatric patients less than 6 years old with psoriatic arthritis.

Crohn's Disease and Ulcerative Colitis

The safety and effectiveness of OTULFI have not been established in pediatric patients with Crohn's disease or ulcerative colitis.

8.5 Geriatric Use

Of the 6709 subjects exposed to ustekinumab, a total of 340 were 65 years of age or older (183 subjects with plaque psoriasis, 65 subjects with psoriatic arthritis, 58 subjects with Crohn's disease and 34 subjects with ulcerative colitis), and 40 subjects were 75 years of age or older. Clinical trials of ustekinumab did not include sufficient numbers of subjects 65 years of age and older to determine whether they respond differently from younger adult subjects.

10 OVERDOSAGE

Single doses up to 6 mg/kg intravenously have been administered in clinical trials without dose-limiting toxicity. In case of overdosage, monitor the patient for any signs or symptoms of adverse reactions or effects and institute appropriate symptomatic treatment immediately. Consider contacting the Poison Help line (1-800-222-1222) or a medical toxicologist for additional overdose management recommendations.

11 DESCRIPTION

Ustekinumab-aauz, a human IgG1 κ monoclonal antibody, is a human interleukin-12 and -23 antagonist. Using DNA recombinant technology, ustekinumab-aauz is produced in a Chinese hamster ovary (CHO) cell line. The manufacturing process contains steps for the clearance of viruses. Ustekinumab-aauz is comprised of 1326 amino acids and has an estimated molecular mass that ranges from 148,079 to 149,690 Daltons.

OTULFI (ustekinumab-aauz) injection is a sterile, preservative-free, clear to slightly

opalescent, and colorless to slightly brown-yellow solution with pH of 5.7- 6.3.

OTULFI for Subcutaneous Use

Available as 45 mg of ustekinumab-aaaz in 0.5 mL and 90 mg of ustekinumab-aaaz in 1 mL, supplied as a sterile solution in a single-dose prefilled syringe with a 27 gauge fixed ½ inch needle and as 45 mg of ustekinumab in 0.5 mL in a single-dose 3 mL Type I glass with a coated stopper. The syringe is fitted with a passive needle guard and a needle cover that is not made with natural rubber (latex).

Each 0.5 mL prefilled syringe or vial delivers 45 mg ustekinumab-aaaz, histidine (0.512 mg), Polysorbate 80 (0.02 mg), sucrose (38 mg) and hydrochloric acid (to adjust pH).

Each 1 mL prefilled syringe delivers 90 mg ustekinumab-aaaz, histidine (1.024 mg), Polysorbate 80 (0.04 mg), sucrose (76 mg) and hydrochloric acid (to adjust pH).

OTULFI for Intravenous Infusion

Available as 130 mg of ustekinumab-aaaz in 26 mL, supplied as a single-dose 30 mL Type I glass vial with a coated stopper.

Each 26 mL vial delivers 130 mg ustekinumab-aaaz, edetate disodium (0.47 mg), histidine (20 mg), L-histidine hydrochloride monohydrate (27 mg), methionine (10.4 mg), Polysorbate 80 (10.4 mg) and sucrose (2210 mg).

12 CLINICAL PHARMACOLOGY

12.1 Mechanism of Action

Ustekinumab products are human IgG1κ monoclonal antibodies that bind with specificity to the p40 protein subunit used by both the IL-12 and IL-23 cytokines. IL-12 and IL-23 are naturally occurring cytokines that are involved in inflammatory and immune responses, such as natural killer cell activation and CD4+ T-cell differentiation and activation. In *in vitro* models, ustekinumab products were shown to disrupt IL-12 and IL-23 mediated signaling and cytokine cascades by disrupting the interaction of these cytokines with a shared cell-surface receptor chain, IL-12Rβ1. The cytokines IL-12 and IL-23 have been implicated as important contributors to the chronic inflammation that is a hallmark of Crohn's disease and ulcerative colitis. In animal models of colitis, genetic absence or antibody blockade of the p40 subunit of IL-12 and IL-23, the target of ustekinumab products was shown to be protective.

12.2 Pharmacodynamics

Plaque Psoriasis

In a small exploratory trial, a decrease was observed in the expression of mRNA of its molecular targets IL-12 and IL-23 in lesional skin biopsies measured at baseline and up to two weeks post-treatment in subjects with plaque psoriasis.

Ulcerative Colitis

In both trial UC-1 (induction) and trial UC-2 (maintenance), a positive relationship was observed between exposure and rates of clinical remission, clinical response, and endoscopic improvement. The response rate approached a plateau at the ustekinumab exposures associated with the recommended dosing regimen for maintenance treatment [*see Clinical Studies (14.5)*].

12.3 Pharmacokinetics

Absorption

In adult subjects with plaque psoriasis, the median time to reach the maximum serum concentration (T_{max}) was 13.5 days and 7 days, respectively, after a single subcutaneous administration of 45 mg (N=22) and 90 mg (N=24) of ustekinumab. In healthy subjects (N=30), the median T_{max} value (8.5 days) following a single subcutaneous administration of 90 mg of ustekinumab was comparable to that observed in subjects with plaque psoriasis.

Following multiple subcutaneous doses of ustekinumab in adult subjects with plaque psoriasis, steady- state serum concentrations of ustekinumab were achieved by Week 28. The mean (\pm SD) steady- state trough serum ustekinumab concentrations were 0.69 ± 0.69 mcg/mL for subjects less than or equal to 100 kg receiving a 45 mg dose and 0.74 ± 0.78 mcg/mL for subjects greater than 100 kg receiving a 90 mg dose. There was no apparent accumulation in serum ustekinumab concentration over time when given subcutaneously every 12 weeks.

Following the recommended intravenous induction dose, mean \pm SD peak serum ustekinumab concentration was 125.2 ± 33.6 mcg/mL in subjects with Crohn's disease, and 129.1 ± 27.6 mcg/mL in subjects with ulcerative colitis. Starting at Week 8, the recommended subcutaneous maintenance dosing of 90 mg ustekinumab was administered every 8 weeks. Steady state ustekinumab concentration was achieved by the start of the second maintenance dose. There was no apparent accumulation in ustekinumab concentration over time when given subcutaneously every 8 weeks. Mean \pm SD steady-state trough concentration was 2.5 ± 2.1 mcg/mL in subjects with Crohn's disease, and 3.3 ± 2.3 mcg/mL in subjects with ulcerative colitis for 90 mg ustekinumab administered every 8 weeks.

Distribution

Population pharmacokinetic analyses showed that the volume of distribution of ustekinumab in the central compartment was 2.7 L (95% CI: 2.69, 2.78) in subjects with Crohn's disease and 3.0 L (95% CI: 2.96, 3.07) in subjects with ulcerative colitis. The total volume of distribution at steady- state was 4.6 L in subjects with Crohn's disease and 4.4 L in subjects with ulcerative colitis.

Elimination

The mean (\pm SD) half-life ranged from 14.9 ± 4.6 to 45.6 ± 80.2 days across all plaque psoriasis trials following subcutaneous administration. Population pharmacokinetic analyses showed that the clearance of ustekinumab was 0.19 L/day (95% CI: 0.185, 0.197) in subjects with Crohn's disease and 0.19 L/day (95% CI: 0.179, 0.192) in subjects with ulcerative colitis with an estimated median terminal half-life of approximately 19 days for both IBD (Crohn's disease and ulcerative colitis) populations.

These results indicate the pharmacokinetics of ustekinumab were similar between subjects with Crohn's disease and ulcerative colitis.

Metabolism

The metabolic pathway of ustekinumab products has not been characterized. As a human IgG1 κ monoclonal antibody, ustekinumab products are expected to be degraded into small peptides and amino acids via catabolic pathways in the same manner as endogenous IgG.

Specific Populations

Weight

When given the same dose, subjects with plaque psoriasis or psoriatic arthritis weighing more than 100 kg had lower median serum ustekinumab concentrations compared with those subjects weighing 100 kg or less. The median trough serum concentrations of ustekinumab in subjects of higher weight (greater than 100 kg) in the 90 mg group were comparable to those in subjects of lower weight (100 kg or less) in the 45 mg group.

Age: Geriatric Population

A population pharmacokinetic analysis (N=106/1937 subjects with plaque psoriasis greater than or equal to 65 years old) was performed to evaluate the effect of age on the pharmacokinetics of ustekinumab. There were no apparent changes in pharmacokinetic parameters (clearance and volume of distribution) in subjects older than 65 years old.

Age: Pediatric Population

Following multiple recommended doses of ustekinumab in pediatric subjects 6 to 17 years of age with plaque psoriasis, steady-state serum concentrations of ustekinumab were achieved by Week 28. At Week 28, the mean \pm SD steady-state trough serum ustekinumab concentrations were 0.36 ± 0.26 mcg/mL and 0.54 ± 0.43 mcg/mL, respectively, in pediatric subjects 6 to 11 years of age and pediatric subjects 12 to 17 years of age.

Overall, the observed steady state ustekinumab trough concentrations in pediatric subjects with plaque psoriasis were within the range of those observed for adult subjects with plaque psoriasis and adult subjects with PsA after administration of ustekinumab.

Drug Interaction Studies

The effects of IL-12 or IL-23 on the regulation of CYP450 enzymes were evaluated in an *in vitro* study using human hepatocytes, which showed that IL-12 and/or IL-23 at levels of 10 ng/mL did not alter human CYP450 enzyme activities (CYP1A2, 2B6, 2C9, 2C19, 2D6, or 3A4).

No clinically significant changes in exposure of caffeine (CYP1A2 substrate), warfarin (CYP2C9 substrate), omeprazole (CYP2C19 substrate), dextromethorphan (CYP2D6 substrate), or midazolam (CYP3A substrate) were observed when used concomitantly with ustekinumab at the approved recommended dosage in subjects with Crohn's disease. [see *Drug Interactions* (7.2)].

Population pharmacokinetic analyses indicated that the clearance of ustekinumab was not impacted by concomitant MTX, NSAIDs, and oral corticosteroids, or prior exposure to a TNF blocker in subjects with psoriatic arthritis.

In subjects with Crohn's disease and ulcerative colitis, population pharmacokinetic analyses did not indicate changes in ustekinumab clearance with concomitant use of corticosteroids or immunomodulators (AZA, 6-MP, or MTX); and serum ustekinumab concentrations were not impacted by concomitant use of these medications.

13 NONCLINICAL TOXICOLOGY

13.1 Carcinogenesis, Mutagenesis, Impairment of Fertility

Animal studies have not been conducted to evaluate the carcinogenic or mutagenic potential of ustekinumab products. Published literature showed that administration of murine IL-12 caused an anti-tumor effect in mice that contained transplanted tumors and IL-12/IL-23p40 knockout mice or mice treated with anti-IL-12/IL-23p40 antibody had decreased host defense to tumors. Mice genetically manipulated to be deficient in both IL-12 and IL-23 or IL-12 alone developed UV-induced skin cancers earlier and more frequently compared to wild-type mice. The relevance of these experimental findings in mouse models for malignancy risk in humans is unknown.

No effects on fertility were observed in male cynomolgus monkeys that were administered ustekinumab at subcutaneous doses up to 45 mg/kg twice weekly (45 times the MRHD on a mg/kg basis) prior to and during the mating period. However, fertility and pregnancy outcomes were not evaluated in mated females.

No effects on fertility were observed in female mice that were administered an analogous IL-12/IL-23p40 antibody by subcutaneous administration at doses up to 50 mg/kg, twice weekly, prior to and during early pregnancy.

13.2 Animal Toxicology and/or Pharmacology

In a 26-week toxicology study, one out of 10 monkeys subcutaneously administered 45 mg/kg ustekinumab twice weekly for 26 weeks had a bacterial infection.

14 CLINICAL STUDIES

14.1 Adult Plaque Psoriasis

Two multicenter, randomized, double-blind, placebo-controlled trials (Ps STUDY 1 and Ps STUDY 2) enrolled a total of 1996 subjects 18 years of age and older with plaque psoriasis who had a minimum body surface area involvement of 10%, and Psoriasis Area and Severity Index (PASI) score ≥ 12 , and who were candidates for phototherapy or systemic therapy. Subjects with guttate, erythrodermic, or pustular psoriasis were excluded from the trials.

Ps STUDY 1 enrolled 766 subjects and Ps STUDY 2 enrolled 1230 subjects. The trials had the same design through Week 28. In both trials, subjects were randomized in equal proportion to placebo, 45 mg or 90 mg of ustekinumab. Subjects randomized to ustekinumab received 45 mg or 90 mg doses, regardless of weight, at Weeks 0, 4, and 16. Subjects randomized to receive placebo at Weeks 0 and 4 crossed over to receive ustekinumab (either 45 mg or 90 mg) at Weeks 12 and 16.

In both trials, subjects in all treatment groups had a median baseline PASI score ranging from approximately 17 to 18. Baseline PGA score was marked or severe in 44% of subjects in Ps STUDY 1 and 40% of subjects in Ps STUDY 2. Approximately two-thirds of all subjects had received prior phototherapy, 69% had received either prior conventional systemic or biologic therapy for the treatment of psoriasis, with 56% receiving prior conventional systemic therapy and 43% receiving prior biologic therapy. A total of 28% of subjects had a history of psoriatic arthritis.

In both trials, the endpoints were the proportion of subjects who achieved at least a 75% reduction in PASI score (PASI 75) from baseline to Week 12 and treatment success (cleared or minimal) on the Physician's Global Assessment (PGA). The PGA is a 6-category scale ranging from 0 (cleared) to 5 (severe) that indicates the physician's overall assessment of psoriasis focusing on plaque thickness/induration, erythema, and scaling.

Clinical Response

The results of Ps STUDY 1 and Ps STUDY 2 are presented in Table 8 below.

Table 8: Clinical Outcomes at Week 12 in Adults with Plaque Psoriasis in Ps STUDY 1 and Ps STUDY 2

	Ps STUDY 1			Ps STUDY 2		
	Placebo	ustekinumab		Placebo	ustekinumab	
		45 mg	90 mg		45 mg	90 mg
Subjects randomized	255	255	256	410	409	411
PASI 75 response	8 (3%)	171 (67%)	170 (66%)	15 (4%)	273 (67%)	311 (76%)
PGA of Cleared or Minimal	10 (4%)	151 (59%)	156 (61%)	18 (4%)	277 (68%)	300 (73%)

Examination of age, gender, and race subgroups did not identify differences in response to ustekinumab among these subgroups.

In subjects who weighed 100 kg or less, response rates were comparable with both the 45 mg and 90 mg doses; however, in subjects who weighed greater than 100 kg, higher response rates were seen with 90 mg dosing compared with 45 mg dosing (Table 9 below).

Table 9: Clinical Outcomes by Weight at Week 12 in Adults with Plaque Psoriasis in Ps STUDY 1 and Ps STUDY 2

	Ps STUDY 1			Ps STUDY 2		
	Placebo	ustekinumab		Placebo	ustekinumab	
		45 mg	90 mg		45 mg	90 mg
Subjects randomized	255	255	256	410	409	411
PASI 75 response						
≤100 kg	4%	74%	65%	4%	73%	78%
	6/166	124/168	107/164	12/290	218/297	225/289
>100 kg	2%	54%	68%	3%	49%	71%
	2/89	47/87	63/92	3/120	55/112	86/121
PGA of Cleared or Minimal						
≤100 kg	4%	64%	63%	5%	74%	75%
	7/166	108/168	103/164	14/290	220/297	216/289
>100 kg	3%	49%	58%	3%	51%	69%
	3/89	43/87	53/92	4/120	57/112	84/121

* Subjects were dosed with trial medication at Weeks 0 and 4.

Subjects in Ps STUDY 1 who were PASI 75 responders at both Weeks 28 and 40 were re-randomized at Week 40 to either continued dosing of ustekinumab (ustekinumab at Week 40) or to withdrawal of therapy (placebo at Week 40). At Week 52, 89% (144/162) of subjects re-randomized to ustekinumab treatment were PASI 75 responders compared with 63% (100/159) of subjects re-randomized to placebo (treatment withdrawal after Week 28 dose). The median time to loss of PASI 75 response among the subjects randomized to treatment withdrawal was 16 weeks.

14.2 Pediatric Plaque Psoriasis

A multicenter, randomized, double blind, placebo-controlled trial (Ps STUDY 3) enrolled 110 pediatric subjects 12 to 17 years of age with a minimum BSA involvement of 10%, a PASI score greater than or equal to 12, and a PGA score greater than or equal to 3, who were candidates for phototherapy or systemic therapy and whose disease was inadequately controlled by topical therapy.

Subjects were randomized to receive placebo (n = 37), the recommended dose of ustekinumab₂₄

(n = 36), or one-half the recommended dose of ustekinumab (n = 37) by subcutaneous injection at Weeks 0 and 4 followed by dosing every 12 weeks (q12w). The recommended dose of ustekinumab was 0.75 mg/kg for subjects weighing less than 60 kg, 45 mg for subjects weighing 60 kg to 100 kg, and 90 mg for subjects weighing greater than 100 kg. At Week 12, subjects who received placebo were crossed over to receive ustekinumab at the recommended dose or one-half the recommended dose.

Of the pediatric subjects, approximately 63% had prior exposure to phototherapy or conventional systemic therapy and approximately 11% had prior exposure to biologics.

The endpoints were the proportion of subjects who achieved a PGA score of cleared (0) or minimal (1), PASI 75, and PASI 90 at Week 12. Subjects were followed for up to 60 weeks following first administration of trial agent.

Clinical Response

The efficacy results at Week 12 for Ps STUDY 3 are presented in Table 10.

Table 10: Efficacy Results at Week 12 in Pediatric Subjects 12 to 17 years with Plaque Psoriasis in Ps STUDY 3

	Ps STUDY 3	
	Placebo n (%)	ustekinumab * n (%)
N	37	36
PGA		
PGA of cleared (0) or minimal (1)	2 (5.4%)	25 (69.4%)
PASI		
PASI 75 responders	4 (10.8%)	29 (80.6%)
PASI 90 responders	2 (5.4%)	22 (61.1%)

* Using the weight-based dosage regimen specified in Table 1 and Table 2.

14.3 Psoriatic Arthritis

The safety and efficacy of ustekinumab was assessed in 927 subjects (PsA STUDY 1, n=615; PsA STUDY 2, n=312), in two randomized, double-blind, placebo-controlled trials in adult subjects 18 years of age and older with active PsA (≥ 5 swollen joints and ≥ 5 tender joints despite non-steroidal anti-inflammatory (NSAID) or disease modifying antirheumatic (DMARD) therapy. Subjects in these trials had a diagnosis of PsA for at least 6 months. Subjects with each subtype of PsA were enrolled, including polyarticular arthritis with the absence of rheumatoid nodules (39%), spondylitis with peripheral arthritis (28%), asymmetric peripheral arthritis (21%), distal interphalangeal involvement (12%) and arthritis mutilans (0.5%). Over 70% and 40% of the subjects, respectively, had enthesitis and dactylitis at baseline.

Subjects were randomized to receive treatment with ustekinumab 45 mg, 90 mg, or placebo subcutaneously at Weeks 0 and 4 followed by every 12 weeks (q12w) dosing. Approximately 50% of subjects continued on stable doses of MTX (≤ 25 mg/week). The primary endpoint was the percentage of subjects achieving ACR 20 response at Week 24.

In PsA STUDY 1 and PsA STUDY 2, 80% and 86% of the subjects, respectively, had been previously treated with DMARDs. In PsA STUDY 1, previous treatment with anti-tumor necrosis factor (TNF)- α agent was not allowed. In PsA STUDY 2, 58% (n=180) of the subjects had been previously treated with TNF blocker, of whom over 70% had discontinued their TNF blocker treatment for lack of efficacy or intolerance at any time.

Clinical Response

In both trials, a greater proportion of subjects achieved ACR 20, ACR 50 and PASI 75 response in the ustekinumab 45 mg and 90 mg groups compared to placebo at Week 24 (see Table 11). ACR 70 responses were also higher in the ustekinumab 45 mg and 90 mg groups, although the difference was only numerical ($p=NS$) in STUDY 2. Responses were consistent in subjects treated with ustekinumab alone or in combination with methotrexate. Responses were similar in subjects regardless of prior TNF α exposure.

Table 11: ACR 20, ACR 50, ACR 70 and PASI 75 responses in PsA STUDY 1 and PsA STUDY 2 at Week 24

	PsA STUDY 1			PsA STUDY 2		
	Placebo	ustekinumab		Placebo	ustekinumab	
		45 mg	90 mg		45 mg	90 mg
Number of subjects randomized	206	205	204	104	103	105
ACR 20 response, N (%)	47 (23%)	87 (42%)	101 (50%)	21 (20%)	45 (44%)	46 (44%)
ACR 50 response, N (%)	18 (9%)	51 (25%)	57 (28%)	7 (7%)	18 (17%)	24 (23%)
ACR 70 response, N (%)	5 (2%)	25 (12%)	29 (14%)	3 (3%)	7 (7%)	9 (9%)
Number of subjects with $\geq 3\%$ BSA^a	146	145	149	80	80	81
PASI 75 response, N (%)	16 (11%)	83 (57%)	93 (62%)	4 (5%)	41 (51%)	45 (56%)

^a Number of subjects with $\geq 3\%$ BSA psoriasis skin involvement at baseline

The percent of subjects achieving ACR 20 responses by visit is shown in Figure 1.

Figure 1: Percent of subjects achieving ACR 20 response through Week 24

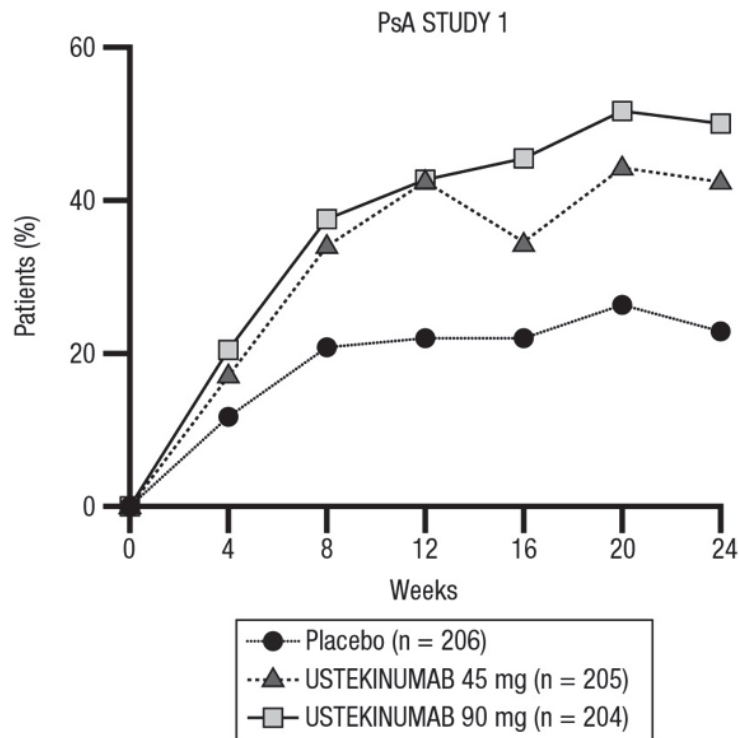

The results of the components of the ACR response criteria are shown in Table 12.

Table 12: Mean change from baseline in ACR components at Week 24

	PsA STUDY 1		
	Placebo (N = 206)	45 mg (N = 205)	ustekinumab 90 mg (N = 204)
Number of swollen joints ^a			
Baseline	15	12	13
Mean Change at Week 24	-3	-5	-6
Number of tender joints ^b			
Baseline	25	22	23
Mean Change at Week 24	-4	-8	-9
Subject's assessment of pain ^c			
Baseline	6.1	6.2	6.6
Mean Change at Week 24	-0.5	-2.0	-2.6
Subject global assessment ^e			
Baseline	6.1	6.3	6.4
Mean Change at Week 24	-0.5	-2.0	-2.5
Physician global assessment ^c			
Baseline	5.8	5.7	6.1
Mean Change at Week 24	-1.4	-2.6	-3.1
Disability index (HAQ) ^d			
Baseline	1.2	1.2	1.2
Mean Change at Week 24	-0.1	-0.3	-0.4
CRP (mg/dL) ^e			
Baseline	1.6	1.7	1.8
Mean Change at Week 24	0.01	-0.5	-0.8

^a Number of swollen joints counted (0-66)

^b Number of tender joints counted (0-68)

^c Visual analogue scale; 0= best, 10=worst.

^d Disability Index of the Health Assessment Questionnaire; 0 = best, 3 = worst, measures the patient's ability to perform the following: dress/groom, arise, eat, walk, reach, grip, maintain hygiene, and maintain daily activity.

^e CRP: (Normal Range 0.0-1.0 mg/dL)

An improvement in enthesitis and dactylitis scores was observed in each ustekinumab group compared with placebo at Week 24.

Physical Function

Ustekinumab-treated subjects showed improvement in physical function compared to subjects treated with placebo as assessed by HAQ-DI at Week 24. In both trials, the proportion of HAQ-DI responders (≥ 0.3 improvement in HAQ-DI score) was greater in the ustekinumab 45 mg and 90 mg groups compared to placebo at Week 24.

14.4 Crohn's Disease

Ustekinumab was evaluated in three randomized, double-blind, placebo-controlled clinical trials in adult subjects with moderately to severely active Crohn's disease (Crohn's Disease Activity Index [CDAI] score of 220 to 450). There were two 8-week intravenous induction trials (CD-1 and CD-2) followed by a 44-week subcutaneous randomized withdrawal maintenance trial (CD-3) representing 52 weeks of therapy. Subjects in CD-1 had failed or were intolerant to treatment with one or more TNF blockers, while subjects in CD-2 had failed or were intolerant to treatment with immunomodulators or corticosteroids, but never failed treatment with a TNF₂₈

blocker.

Trials CD-1 and CD-2

In trials CD-1 and CD-2, 1409 subjects were randomized, of whom 1368 (CD-1, n=741; CD-2, n=627) were included in the final efficacy analysis. Induction of clinical response (defined as a reduction in CDAI score of greater than or equal to 100 points or CDAI score of less than 150) at Week 6 and clinical remission (defined as a CDAI score of less than 150) at Week 8 were evaluated. In both trials, subjects were randomized to receive a single intravenous administration of ustekinumab at either approximately 6 mg/kg, placebo (see Table 4), or 130 mg (a lower dose than recommended).

In trial CD-1, subjects had failed or were intolerant to prior treatment with a TNF blocker: 29% subjects had an inadequate initial response (primary non-responders), 69% responded but subsequently lost response (secondary non-responders) and 36% were intolerant to a TNF blocker. Of these subjects, 48% failed or were intolerant to one TNF blocker and 52% had failed 2 or 3 prior TNF blockers. At baseline and throughout the trial, approximately 46% of the subjects were receiving corticosteroids and 31% of the subjects were receiving immunomodulators (AZA, 6-MP, MTX). The median baseline CDAI score was 319 in the ustekinumab approximately 6 mg/kg group and 313 in the placebo group.

In trial CD-2, subjects had failed or were intolerant to prior treatment with corticosteroids (81% of subjects), at least one immunomodulator (6-MP, AZA, MTX; 68% of subjects), or both (49% of subjects). Additionally, 69% never received a TNF blocker and 31% previously received but had not failed a TNF blocker. At baseline, and throughout the trial, approximately 39% of the subjects were receiving corticosteroids and 35% of the subjects were receiving immunomodulators (AZA, 6-MP, MTX). The median baseline CDAI score was 286 in the ustekinumab and 290 in the placebo group.

In these induction trials, a greater proportion of subjects treated with ustekinumab (at the recommended dose of approximately 6 mg/kg dose) achieved clinical response at Week 6 and clinical remission at Week 8 compared to placebo (see Table 13 for clinical response and remission rates). Clinical response and remission were significant as early as Week 3 in ustekinumab-treated subjects and continued to improve through Week 8.

Table 13: Induction of Clinical Response and Remission in CD-1* and CD-2**

	CD-1 n = 741			CD-2 n = 627		
	Placebo N = 247	ustekinumab † N = 249	Treatment difference and 95% CI	Placebo N = 209	ustekinumab † N = 209	Treatment difference and 95% CI
Clinical Response (100 point), Week 6	53 (21%)	84 (34%) ^a	12% (4%, 20%)	60 (29%)	116 56% ^b	27% (18%, 36%)
Clinical Remission, Week 8	18 (7%)	52 (21%) ^b	14% (8%, 20%)	41 (20%)	84 (40%) ^b	21% (12%, 29%)
Clinical Response (100 point), Week 8	50 (20%)	94 (38%) ^b	18% (10%, 25%)	67 (32%)	121 58% ^b	26% (17%, 35%)
70 Point Response, Week 6	75 (30%)	109 44% ^a	13% (5%, 22%)	81 (39%)	135 65% ^b	26% (17%, 35%)
70 Point Response, Week 3	67 (27%)	101 41% ^a	13% (5%, 22%)	66 (32%)	106 51% ^b	19% (10%, 28%)

Clinical remission is defined as CDAI score < 150; Clinical response is defined as reduction in CDAI score by at least 100 points or being in clinical remission: 70 point response is defined as reduction in CDAI score by at least 70 points

* Patient population consisted of subjects who failed or were intolerant to TNF blocker therapy

** Patient population consisted of subjects who failed or were intolerant to corticosteroids or immunomodulators (e.g., 6-MP, AZA, MTX) and previously received but not failed a TNF blocker or were never treated with a TNF blocker.

† Infusion dose of ustekinumab using the weight-based dosage regimen specified in Table 3.

^a 0.001 ≤ p < 0.01

^b p < 0.001

Trial CD-3

The maintenance trial (CD-3) evaluated 388 subjects who achieved clinical response ≥100-point reduction in CDAI score) at Week 8 with either induction dose of ustekinumab in trials CD-1 or CD-2. Subjects were randomized to receive a subcutaneous maintenance regimen of either 90 mg ustekinumab every 8 weeks or placebo for 44 weeks (see Table 14).

Table 14: Clinical Response and Remission in CD-3 (Week 44; 52 weeks from initiation of the induction dose)

	Placebo* N = 131 [†]	90 mg ustekinumab every 8 weeks N = 128 [†]	Treatment difference and 95% CI
Clinical Remission	47 (36%)	68 (53%) ^a	17% (5%, 29%)
Clinical Response	58 (44%)	76 (59%) ^b	15% (3%, 27%)
Clinical Remission in subjects in remission at the start of maintenance therapy**	36/79 (46%)	52/78 (67%) ^a	21% (6%, 36%)

Clinical remission is defined as CDAI score < 150; Clinical response is defined as reduction in CDAI of at least 100 points or being in clinical remission

* The placebo group consisted of subjects who were in response to ustekinumab and were randomized to receive placebo at the start of maintenance therapy.

** Subjects in remission at the end of maintenance therapy who were in remission at the start of maintenance therapy. This does not account for any other time point during maintenance therapy.

† Subjects who achieved clinical response to ustekinumab at the end of the induction trial.

^a p < 0.01

^b 0.01 ≤ p < 0.05

At Week 44, 47% of subjects who received ustekinumab were corticosteroid-free and in clinical remission, compared to 30% of subjects in the placebo group.

At Week 0 of trial CD-3, 34/56 (61%) ustekinumab-treated subjects who previously failed or were intolerant to TNF blocker therapies were in clinical remission and 23/56 (41%) of these subjects were in clinical remission at Week 44. In the placebo arm, 27/61 (44%) subjects were in clinical remission at Week 0 while 16/61 (26%) of these subjects were in remission at Week 44.

At Week 0 of trial CD-3, 46/72 (64%) ustekinumab-treated subjects who had previously failed immunomodulator therapy or corticosteroids (but not TNF blockers) were in clinical remission and 45/72 (63%) of these subjects were in clinical remission at Week 44. In the placebo arm, 50/70 (71%) of these subjects were in clinical remission at Week 0 while 31/70 (44%) were in remission at Week 44. In the subset of these subjects who were also naïve to TNF blockers, 34/52 (65%) of ustekinumab-treated subjects were in clinical remission at Week 44 as compared to 25/51 (49%) in the placebo arm.

Subjects who were not in clinical response 8 weeks after ustekinumab induction were not included in the primary efficacy analyses for trial CD-3; however, these subjects were eligible to receive a 90 mg subcutaneous injection of ustekinumab upon entry into trial CD-3. Of these subjects, 102/219 (47%) achieved clinical response eight weeks later and were followed for the₃₀

duration of the trial.

14.5 Ulcerative Colitis

Ustekinumab was evaluated in two randomized, double-blind, placebo-controlled clinical trials [UC-1 and UC-2 (NCT02407236)] in adult subjects with moderately to severely active ulcerative colitis who had an inadequate response to or failed to tolerate a biologic (i.e., TNF blocker and/or vedolizumab), corticosteroids, and/or 6-MP or AZA therapy. The 8-week intravenous induction trial (UC-1) was followed by the 44-week subcutaneous randomized withdrawal maintenance trial (UC-2) for a total of 52 weeks of therapy.

Disease assessment was based on the Mayo score, which ranged from 0 to 12 and has four subscores that were each scored from 0 (normal) to 3 (most severe): stool frequency, rectal bleeding, findings on centrally reviewed endoscopy, and physician global assessment. Moderately to severely active ulcerative colitis was defined at baseline (Week 0) as Mayo score of 6 to 12, including a Mayo endoscopy subscore ≥ 2 . An endoscopy score of 2 was defined by marked erythema, absent vascular pattern, friability, erosions; and a score of 3 was defined by spontaneous bleeding, ulceration. At baseline, subjects had a median Mayo score of 9, with 84% of subjects having moderate disease (Mayo score 6-10) and 15% having severe disease (Mayo score 11-12).

Subjects in these trials may have received other concomitant therapies including aminosalicylates, immunomodulatory agents (AZA, 6-MP, or MTX), and oral corticosteroids (prednisone).

Trial UC-1

In UC-1, 961 subjects were randomized at Week 0 to a single intravenous administration of ustekinumab of approximately 6 mg/kg, 130 mg (a lower dose than recommended), or placebo. Subjects enrolled in UC-1 had to have failed therapy with corticosteroids, immunomodulators or at least one biologic. A total of 51% had failed at least one biologic and 17% had failed both a TNF blocker and an integrin receptor blocker. Of the total population, 46% had failed corticosteroids or immunomodulators but were biologic-naïve and an additional 3% had previously received but had not failed a biologic. At induction baseline and throughout the trial, approximately 52% subjects were receiving oral corticosteroids, 28% subjects were receiving immunomodulators (AZA, 6-MP, or MTX) and 69% subjects were receiving aminosalicylates.

The primary endpoint was clinical remission at Week 8. Clinical remission with a definition of: Mayo stool frequency subscore of 0 or 1, Mayo rectal bleeding subscore of 0 (no rectal bleeding), and Mayo endoscopy subscore of 0 or 1 (Mayo endoscopy subscore of 0 defined as normal or inactive disease and Mayo subscore of 1 defined as presence of erythema, decreased vascular pattern and no friability) is provided in Table 15.

The secondary endpoints were clinical response, endoscopic improvement, and histologic-endoscopic mucosal improvement. Clinical response with a definition of (≥ 2 points and $\geq 30\%$ decrease in modified Mayo score, defined as 3-component Mayo score without the Physician's Global Assessment, with either a decrease from baseline in the rectal bleeding subscore ≥ 1 or a rectal bleeding subscore of 0 or 1), endoscopic improvement with a definition of Mayo endoscopy subscore of 0 or 1, and histologic-endoscopic mucosal improvement with a definition of combined endoscopic improvement and histologic improvement of the colon tissue [neutrophil infiltration in $<5\%$ of crypts, no crypt destruction, and no erosions, ulcerations, or granulation tissue]) are provided in Table 14.

In UC-1, a significantly greater proportion of subjects treated with ustekinumab (at the₃₁

recommended dose of approximately 6 mg/kg dose) were in clinical remission and response and achieved endoscopic improvement and histologic-endoscopic mucosal improvement compared to placebo (see Table 15).

Table 15: Proportion of Subjects Meeting Efficacy Endpoints at Week 8 in UC-1

Endpoint	Placebo N = 319		ustekinumab † N = 322		Treatment difference and 97.5% CI ^a
	N	%	N	%	
Clinical Remission*	22	7%	62	19%	12% (7%, 18%) ^b
Bio-naïve [‡]	14/151	9%	36/147	24%	
Prior biologic failure	7/161	4%	24/166	14%	
Endoscopic Improvement[§]	40	13%	80	25%	12% (6%, 19%) ^b
Bio-naïve [‡]	28/151	19%	43/147	29%	
Prior biologic failure	11/161	7%	34/166	20%	
Clinical Response[†]	99	31%	186	58%	27% 18%, 35% ^b
Bio-naïve [‡]	55/151	36%	94/147	64%	
Prior biologic failure	42/161	26%	86/166	52%	
Histologic-Endoscopic Mucosal Improvement[‡]	26	8%	54	17%	9% (3%, 14%) ^b
Bio-naïve [‡]	19/151	13%	30/147	20%	
Prior biologic failure	6/161	4%	21/166	13%	

† Infusion dose of ustekinumab using the weight-based dosage regimen specified in Table 3.

‡ An additional 7 subjects on placebo and 9 subjects on ustekinumab (6 mg/kg) had been exposed to, but had not failed, biologics.

* Clinical remission was defined as Mayo stool frequency subscore of 0 or 1, Mayo rectal bleeding subscore of 0, and Mayo endoscopy subscore of 0 or 1 (modified so that 1 does not include friability).

§ Endoscopic improvement was defined as Mayo endoscopy subscore of 0 or 1 (modified so that 1 does not include friability).

† Clinical response was defined as a decrease from baseline in the modified Mayo score by $\geq 30\%$ and ≥ 2 points, with either a decrease from baseline in the rectal bleeding subscore ≥ 1 or a rectal bleeding subscore of 0 or 1.

‡ Histologic-endoscopic mucosal improvement was defined as combined endoscopic improvement (Mayo endoscopy subscore of 0 or 1) and histologic improvement of the colon tissue (neutrophil infiltration in $< 5\%$ of crypts, no crypt destruction, and no erosions, ulcerations, or granulation tissue).

^a Adjusted treatment difference (97.5% CI)

^b $p < 0.001$

The relationship of histologic-endoscopic mucosal improvement, as defined in UC-1, at Week 8 to disease progression and long-term outcomes was not evaluated during UC-1.

Rectal Bleeding and Stool Frequency Subscores

Decreases in rectal bleeding and stool frequency subscores were observed as early as Week 2 in ustekinumab-treated subjects.

Trial UC-2

The maintenance trial (UC-2) evaluated 523 subjects who achieved clinical response 8 weeks following the intravenous administration of either induction dose of ustekinumab in UC-1. These subjects were randomized to receive a subcutaneous maintenance regimen of either 90 mg ustekinumab every 8 weeks, or every 12 weeks (a lower dose than recommended), or placebo for 44 weeks.

The primary endpoint was the proportion of subjects in clinical remission at Week 44. The secondary endpoints included the proportion of subjects maintaining clinical response at Week 44, the proportion of subjects with endoscopic improvement at Week 44, the proportion of subjects with corticosteroid-free clinical remission at Week 44, and the proportion of subjects maintaining clinical remission at Week 44 among subjects who achieved clinical remission 8

weeks after induction.

Results of the primary and secondary endpoints at Week 44 in subjects treated with ustekinumab at the recommended dosage (90 mg every 8 weeks) compared to the placebo are shown in Table 16.

Table 16: Efficacy Endpoints of Maintenance at Week 44 in UC-2 (52 Weeks from Initiation of the Induction Dose)

Endpoint	Placebo* N = 175 [†]		90 mg ustekinumab every 8 weeks N = 176		Treatment difference and 95% CI
	N	%	N	%	
Clinical Remission**	46	26%	79	45%	19% (9%, 28%) ^a
Bio-naïve [‡]	30/84	36%	39/79	49%	
Prior biologic failure	16/88	18%	37/91	41%	
Maintenance of Clinical Response at Week 44[†]	84	48%	130	74%	26% 16%, 36% ^a
Bio-naïve [‡]	49/84	58%	62/79	78%	
Prior biologic failure	35/88	40%	64/91	70%	
Endoscopic Improvement[§]	47	27%	83	47%	20% 11%, 30% ^a
Bio-naïve [‡]	29/84	35%	42/79	53%	
Prior biologic failure	18/88	20%	38/91	42%	
Corticosteroid-free Clinical Remission[‡]	45	26%	76	43%	17% 8%, 27%) ^a
Bio-naïve [‡]	30/84	36%	38/79	48%	
Prior biologic failure	15/88	17%	35/91	38%	
Maintenance of Clinical Remission at Week 44 in subjects who achieved clinical remission 8 weeks after induction	18/50	36%	27/41	66%	31% 12%, 50% ^b
Bio-naïve [‡]	12/27	44%	14/20	70%	
Prior biologic failure	6/23	26%	12/18	67%	

[‡] An additional 3 subjects on placebo and 6 subjects on ustekinumab had been exposed to, but had not failed, biologics.

* The placebo group consisted of subjects who were in response to ustekinumab and were randomized to receive placebo at the start of maintenance therapy.

** Clinical remission was defined as Mayo stool frequency subscore of 0 or 1, Mayo rectal bleeding subscore of 0, and Mayo endoscopy subscore of 0 or 1 (modified so that 1 does not include friability).

[†] Clinical response was defined as a decrease from baseline in the modified Mayo score by $\geq 30\%$ and ≥ 2 points, with either a decrease from baseline in the rectal bleeding subscore ≥ 1 or a rectal bleeding subscore of 0 or 1.

[§] Endoscopic improvement was defined as Mayo endoscopy subscore of 0 or 1 (modified so that 1 does not include friability).

[‡] Corticosteroid-free clinical remission was defined as subjects in clinical remission and not receiving corticosteroids at Week 44.

^a $p < 0.001$

^b $p = 0.004$

Other Endpoints

Week 16 Responders to Ustekinumab Induction

Subjects who were not in clinical response 8 weeks after induction with ustekinumab in UC-1 were not included in the primary efficacy analyses for trial UC-2; however, these subjects were eligible to receive a 90 mg subcutaneous injection of ustekinumab at Week 8. Of these subjects, 55/101 (54%) achieved clinical response eight weeks later (Week 16) and received ustekinumab 90 mg subcutaneously every 8 weeks during the UC-2 trial. At Week 44, there were 97/157 (62%) subjects who maintained clinical response and there were 51/157 (32%) who achieved clinical remission.

Histologic-Endoscopic Mucosal Improvement at Week 44

The proportion of subjects achieving histologic-endoscopic mucosal improvement during maintenance treatment in UC-2 was 75/172 (44%) among subjects on ustekinumab and 40/172 (23%) in subjects on placebo at Week 44. The relationship of histologic-endoscopic mucosal improvement, as defined in UC-2, at Week 44 to progression of disease or long-term outcomes was not evaluated in UC-2.

Endoscopic Normalization

Normalization of endoscopic appearance of the mucosa was defined as a Mayo endoscopic subscore of 0. At Week 8 in UC-1, endoscopic normalization was achieved in 25/322 (8%) of subjects treated with ustekinumab and 12/319 (4%) of subjects in the placebo group. At Week 44 of UC-2, endoscopic normalization was achieved in 51/176 (29%) of subjects treated with ustekinumab and in 32/175 (18%) of subjects in placebo group.

15 REFERENCES

- ¹ Surveillance, Epidemiology, and End Results (SEER) Program (www.seer.cancer.gov) SEER*Stat Database: Incidence - SEER 6.6.2 Regs Research Data, Nov 2009 Sub (1973- 2007) - Linked To County Attributes - Total U.S., 1969-2007 Counties, National Cancer Institute, DCCPS, Surveillance Research Program, Surveillance Systems Branch, released April 2010, based on the November 2009 submission.

16 HOW SUPPLIED/STORAGE AND HANDLING

OTULFI (ustekinumab-aaaz) injection is a sterile, preservative-free, clear to slightly opalescent and colorless to slightly brown-yellow solution. It is supplied as individually packaged, single-dose prefilled syringes or single-dose vials.

For Subcutaneous Use

Prefilled Syringes

- 45 mg/0.5 mL (NDC 65219-824-01)
- 90 mg/mL (NDC 65219-826-26)

Each prefilled syringe is equipped with a 27 gauge fixed ½ inch needle, a needle safety guard, and a needle cover that is not made with natural rubber

Single-dose Vial

- 45 mg/0.5 mL (NDC 65219-822-05)

For Intravenous Infusion

Single-dose Vial

- 130 mg/26 mL (5 mg/mL) (NDC 65219-828-05)

Storage and Stability

Store OTULFI vials and prefilled syringes refrigerated between 2°C to 8°C (36°F to 46°F). Store₃₄

OTULFI vials upright. Keep the product in the original carton to protect from light until the time of use. Do not freeze. Do not shake.

If needed, individual prefilled syringes may be stored at room temperature up to 30°C (86°F) for a maximum single period of up to 30 days in the original carton to protect from light. Record the date when the prefilled syringe is first removed from the refrigerator on the carton in the space provided. Once a syringe has been stored at room temperature, do not return to the refrigerator. Discard the syringe if not used within 30 days at room temperature storage. Do not use OTULFI after the expiration date on the carton or on the prefilled syringe.

17 PATIENT COUNSELING INFORMATION

Advise the patient and/or caregiver to read the FDA-approved patient labeling (Medication Guide and Instructions for Use).

Infections

Inform patients that OTULFI may lower the ability of their immune system to fight infections and to contact their healthcare provider immediately if they develop any signs or symptoms of infection [see *Warnings and Precautions (5.1)*].

Malignancies

Inform patients of the risk of developing malignancies while receiving OTULFI [see *Warnings and Precautions (5.4)*].

Hypersensitivity Reactions

- Advise patients to seek immediate medical attention if they experience any signs or symptoms of serious hypersensitivity reactions and discontinue OTULFI [see *Warnings and Precautions (5.5)*].

Posterior Reversible Encephalopathy Syndrome (PRES)

Inform patients to immediately contact their healthcare provider if they experience signs and symptoms of PRES (which may include headache, seizures, confusion, or visual disturbances) [see *Warnings and Precautions (5.6)*].

Immunizations

Inform patients that OTULFI can interfere with the usual response to immunizations and that they should avoid live vaccines [see *Warnings and Precautions (5.7)*].

Administration

Instruct patients to follow sharps disposal recommendations, as described in the Instructions for Use.

Manufactured by: Fresenius Kabi USA, LLC, Lake Zurich, IL 60047, U.S.A, US License Number 2146

MEDICATION GUIDE

OTULFI [oh tool fee]

(ustekinumab-aauz)

injection, for subcutaneous or intravenous use

What is the most important information I should know about OTULFI?

OTULFI is a medicine that affects your immune system. OTULFI can increase your risk of having serious side effects, including:

Serious infections. OTULFI may lower the ability of your immune system to fight infections and may increase your risk of infections. Some people have serious infections while taking ustekinumab products, including tuberculosis (TB), and infections caused by bacteria, fungi, or viruses. Some people have to be hospitalized for treatment of their infection.

- Your doctor should check you for TB before starting OTULFI.
- If your doctor feels that you are at risk for TB, you may be treated with medicine for TB before you begin treatment with OTULFI and during treatment with OTULFI.
- Your doctor should watch you closely for signs and symptoms of TB while you are being treated with OTULFI.

You should not start taking OTULFI if you have any kind of infection unless your doctor says it is okay.

Before starting OTULFI, tell your doctor if you:

- think you have an infection or have symptoms of an infection such as:
 - fever, sweat, or chills
 - muscle aches
 - cough
 - shortness of breath
 - blood in phlegm
 - weight loss
 - warm, red, or painful skin or sores on your body
 - diarrhea or stomach pain
 - burning when you urinate or urinate more often than normal
 - feel very tired
- are being treated for an infection or have any open cuts.
- get a lot of infections or have infections that keep coming back.
- have TB, or have been in close contact with someone with TB.

After starting OTULFI, call your doctor right away if you have any symptoms of an infection (see above). These may be signs of infections such as chest infections, or skin infections or shingles that could have serious complications. OTULFI can make you more likely to get infections or make an infection that you have worse. People who have a genetic problem where the body does not make any of the proteins interleukin 12 (IL-12) and interleukin 23 (IL-23) are at a higher risk for certain serious infections. These infections can spread throughout the body and cause death. People who take OTULFI may also be more likely to get these infections.

Cancers. OTULFI may decrease the activity of your immune system and increase your risk for certain types of cancers. Tell your doctor if you have ever had any type of cancer. Some people who are receiving ustekinumab products and have risk factors for skin cancer have developed certain types of skin cancers. During your treatment with OTULFI, tell your doctor if you develop any new skin growths.

Posterior Reversible Encephalopathy Syndrome (PRES). PRES is a rare condition that affects the brain and can cause death. The cause of PRES is not known. If PRES is found early and treated, most people recover. Tell your doctor right away if you have any new or worsening medical problems including:

- headache
- seizures
- confusion
- vision problems

What is OTULFI?

OTULFI is a prescription medicine used to treat:

- adults and children 6 years and older with moderate or severe psoriasis who may benefit from taking injections or pills (systemic therapy) or phototherapy (treatment using ultraviolet light alone or with pills).
- adults and children 6 years and older with active psoriatic arthritis.
- adults 18 years and older with moderately to severely active Crohn's disease.
- adults 18 years and older with moderately to severely active ulcerative colitis.

It is not known if OTULFI is safe and effective in children less than 6 years of age.

Do not take OTULFI if you are allergic to ustekinumab products or any of the ingredients in OTULFI. See the end of this Medication Guide for a complete list of ingredients in OTULFI.

Before you receive OTULFI, tell your doctor about all of your medical conditions, including if you:

- have any of the conditions or symptoms listed in the section **“What is the most important information I should know about OTULFI?”**
- ever had an allergic reaction to ustekinumab products. Ask your doctor if you are not sure.
- have recently received or are scheduled to receive an immunization (vaccine). People who take OTULFI should not receive live vaccines. Tell your doctor if anyone in your house needs a live vaccine. The viruses used in some types of live vaccines can spread to people with a weakened immune system and can cause serious problems. **You should not receive the BCG vaccine during the one year before receiving OTULFI or one year after you stop receiving OTULFI.**
- have any new or changing lesions within psoriasis areas or on normal skin.
- are receiving or have received allergy shots, especially for serious allergic reactions. Allergy shots may not work as well for you during treatment with OTULFI. OTULFI may also increase your risk of having an allergic reaction to an allergy shot.
- receive or have received phototherapy for your psoriasis.
- are pregnant or plan to become pregnant. It is not known if OTULFI can harm your unborn baby. You and your doctor should decide if you will receive OTULFI. See **“What should I avoid while using OTULFI?”**
- received OTULFI while you were pregnant. It is important that you tell your baby’s healthcare provider before any vaccinations are given to your baby.
- are breastfeeding or plan to breastfeed. OTULFI can pass into your breast milk.
- Talk to your doctor about the best way to feed your baby if you receive OTULFI.

Tell your doctor about all the medicines you take, including prescription and over-the-counter medicines, vitamins, and herbal supplements.

Know the medicines you take. Keep a list of them to show your doctor and pharmacist when you get a new medicine.

How should I use OTULFI?

- Use OTULFI exactly as your doctor tells you to.
- Adults with Crohn’s disease and ulcerative colitis will receive the first dose of OTULFI through a vein in the arm (intravenous infusion) in a healthcare facility by a healthcare provider. It takes at least 1 hour to receive the full dose of medicine. You will then receive OTULFI as an injection under the skin (subcutaneous injection) 8 weeks after the first dose of OTULFI, as described below.
- Adults with psoriasis or psoriatic arthritis, and children 6 years and older with psoriasis or psoriatic arthritis will receive OTULFI as an injection under the skin (subcutaneous injection) as described below.
- **Injecting OTULFI under your skin**
 - OTULFI is intended for use under the guidance and supervision of your doctor. In children 6 years and older, it is recommended that OTULFI be administered by a healthcare provider. If your doctor decides that you or a caregiver may give your injections of OTULFI at home, you should receive training on the right way to prepare and inject OTULFI. Your doctor will determine the right dose of OTULFI for you, the amount for each injection, and how often you should receive it. Do not try to inject OTULFI yourself until you or your caregiver have been shown how to inject OTULFI by your doctor or nurse.
 - Inject OTULFI under the skin (subcutaneous injection) in your upper arms, buttocks, upper legs (thighs) or stomach area (abdomen).
 - Do not give an injection in an area of the skin that is tender, bruised, red or hard.
 - Use a different injection site each time you use OTULFI.
 - If you inject more OTULFI than prescribed, call your doctor right away.
 - Be sure to keep all of your scheduled follow-up appointments.

Read the detailed Instructions for Use at the end of this Medication Guide for instructions about how to prepare and inject a dose of OTULFI, and how to properly throw away (dispose of) used needles and syringes. The syringe, needle and vial must never be re-used. After the rubber stopper is punctured, OTULFI can become contaminated by harmful bacteria which could cause an infection if re-used. Therefore, throw away any unused portion of OTULFI.

What should I avoid while using OTULFI?

You should not receive a live vaccine while taking OTULFI. See **“Before you receive OTULFI, tell your doctor about all of your medical conditions, including if you:”**

What are the possible side effects of OTULFI?

OTULFI may cause serious side effects, including:

- See “**What is the most important information I should know about OTULFI?**”
- **Serious allergic reactions.** Serious allergic reactions can occur with OTULFI. Stop using OTULFI and get medical help right away if you have any of the following symptoms of a serious allergic reaction:
 - feeling faint
 - swelling of your face, eyelids, tongue, or throat
 - chest tightness
 - skin rash
- **Lung inflammation.** Cases of lung inflammation have happened in some people who receive ustekinumab products and may be serious. These lung problems may need to be treated in a hospital. Tell your doctor right away if you develop shortness of breath or a cough that doesn't go away during treatment with OTULFI.

Common side effects of OTULFI include:

- nasal congestion, sore throat, and runny nose
- upper respiratory infections
- fever
- headache
- tiredness
- itching
- nausea and vomiting
- redness at the injection site
- vaginal yeast infections
- urinary tract infections
- sinus infection
- bronchitis
- diarrhea
- stomach pain

These are not all of the possible side effects of OTULFI. Call your doctor for medical advice about side effects. You may report side effects to FDA at 1-800-FDA-1088. You may also report side effects to Fresenius Kabi USA, LLC at 1-800-551-7176.

How should I store OTULFI?

- Store OTULFI vials and prefilled syringes in a refrigerator between 36°F to 46°F (2°C to 8°C).
- Store OTULFI vials standing up straight.
- Store OTULFI in the original carton to protect it from light until time to use it.
- Do not freeze OTULFI.
- Do not shake OTULFI.

If needed, individual OTULFI prefilled syringes may also be stored at room temperature up to 86°F (30°C) for a maximum single period of up to 30 days in the original carton to protect from light. Record the date when the prefilled syringe is first removed from the refrigerator on the carton in the space provided. Once a syringe has been stored at room temperature, it should not be returned to the refrigerator. Discard the syringe if not used within 30 days at room temperature storage. Do not use OTULFI after the expiration date on the carton or on the prefilled syringe.

Keep OTULFI and all medicines out of the reach of children.

General information about the safe and effective use of OTULFI.

Medicines are sometimes prescribed for purposes other than those listed in a Medication Guide. Do not use OTULFI for a condition for which it was not prescribed. Do not give OTULFI to other people, even if they have the same symptoms that you have. It may harm them. You can ask your doctor or pharmacist for information about OTULFI that was written for health professionals.

What are the ingredients in OTULFI?

Active ingredient: ustekinumab-aaaz

Inactive ingredients: **Single-dose prefilled syringe for subcutaneous use** contains histidine, Polysorbate 80, sucrose and hydrochloric acid (to adjust pH). **Single-dose vial for subcutaneous use** contains histidine, Polysorbate 80, sucrose and hydrochloric acid (to adjust pH). **Single-dose vial for intravenous infusion** contains edetate disodium, histidine, L-histidine hydrochloride monohydrate, methionine, Polysorbate 80, and sucrose.

Manufactured by: Fresenius Kabi USA, LLC, Lake Zurich, IL 60047, U.S.A, US License Number 2146

For more information, call 1-833-522-4227 or visit the patient support program website: www.kabicare.com

This Medication Guide has been approved by the U.S. Food and Drug Administration

Revised: 03/2025

INSTRUCTIONS FOR USE
OTULFI [oh tool fee]
(ustekinumab-aaaz)
injection, for subcutaneous use

Instructions for injecting OTULFI using a prefilled syringe.

Read this Instructions for Use before you start using OTULFI. Your doctor or nurse should show you how to prepare and give your injection of OTULFI the right way.

If you cannot give yourself the injection:

- ask your doctor or nurse to help you, or
- ask someone who has been trained by a doctor or nurse to give your injections.

Do not try to inject OTULFI yourself until you have been shown how to inject OTULFI by your doctor, nurse or health professional.

Important information:

- Before you start, check the carton to make sure that it is the right dose. You will have either 45 mg or 90 mg as prescribed by your doctor.
 - If your dose is 45 mg, you will receive one 45 mg prefilled syringe.
 - If your dose is 90 mg, you will receive either one 90 mg prefilled syringe or two 45 mg prefilled syringes.
If you receive two 45 mg prefilled syringes for a 90 mg dose, you will need to give yourself two injections, one right after the other.
- Children 12 years of age and older with psoriasis, who weigh 132 pounds (60 kg) or more may use a prefilled syringe.
- **Store OTULFI** in a refrigerator between 36°F to 46°F (2°C to 8°C) in the original carton to protect from light.
- If needed, individual OTULFI prefilled syringes may also be stored at room temperature up to 86°F (30°C) for a maximum single period of up to 30 days in the original carton to protect from light. Record the date when the prefilled syringe is first removed from the refrigerator on the carton in the space provided. If a syringe has been stored at room temperature, it should not be returned to the refrigerator.
- Check the expiration date on the prefilled syringe and carton. If the expiration date has passed or if the prefilled syringe has been kept at room temperature up to 86°F (30°C) for longer than a maximum single period of 30 days or if the prefilled syringe has been stored above 86°F (30°C), do not use it. If the expiration date has passed or if the prefilled syringe has been stored above 86°F (30°C), call your doctor or pharmacist, or call or call manufacturer`s phone for help.
- Make sure the syringe is not damaged.
- Check your prefilled syringe for any particles or discoloration. Your prefilled syringe should look clear and colorless to slightly brown-yellow.
- Do not use if it is frozen, discolored, cloudy or has particles. Get a new prefilled syringe.
- **Do not shake the prefilled syringe at any time.** Shaking your prefilled syringe may damage your OTULFI medicine. If your prefilled syringe has been shaken, do not use it. Get a new prefilled syringe.
- To reduce the risk of accidental needle sticks, each prefilled syringe has a needle guard that is automatically activated to cover the needle after you have given your injection. Do not pull back on the plunger at any time.

Gather the supplies you will need to prepare and to give your injection. (See Figure A)

You will need:

- antiseptic wipes
- cotton balls or gauze pads
- adhesive bandage
- your prescribed dose of OTULFI (See Figure B)
- FDA-cleared sharps disposal container. **See "Step 4: Dispose of the syringe."**

Figure A



Figure B

To prevent early activation of the needle safety guard, do not touch the **NEEDLE GUARD ACTIVATION CLIPS** at any time during use.

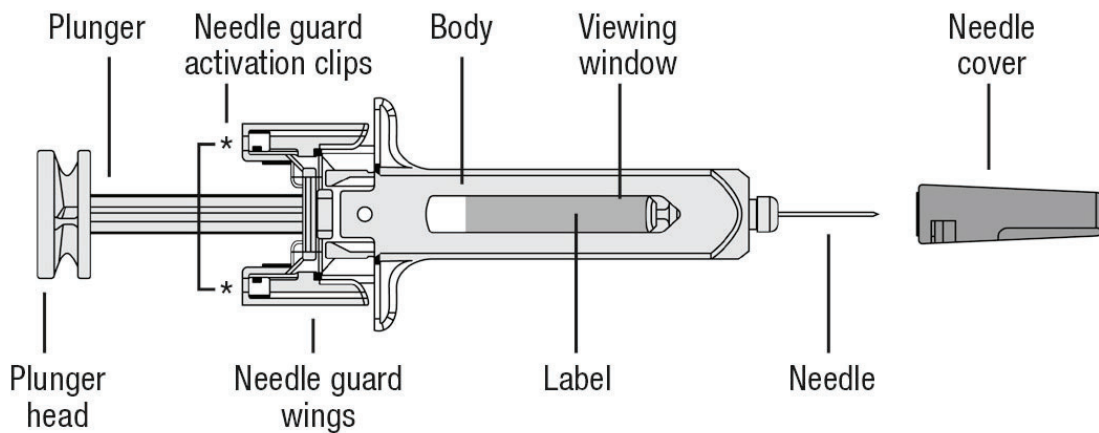

Step 1: Prepare the injection.

- Choose a well-lit, clean, flat work surface.
- Wash your hands well with soap and warm water.
- Hold the prefilled syringe with the covered needle pointing upward.

Step 2: Prepare your injection site

- Choose an injection site around your stomach area (abdomen), buttocks, upper legs (thighs). If a caregiver is giving you the injection, the outer area of the upper arms may also be used. **(See Figure C)**
- **Use a different injection site for each injection. Do not** give an injection in an area of the skin that is tender, bruised, red or hard.
- Clean the skin with an antiseptic wipe where you plan to give your injection.
- Do not touch this area again before giving the injection. Let your skin dry before injecting.
- Do not fan or blow on the clean area.

Figure C

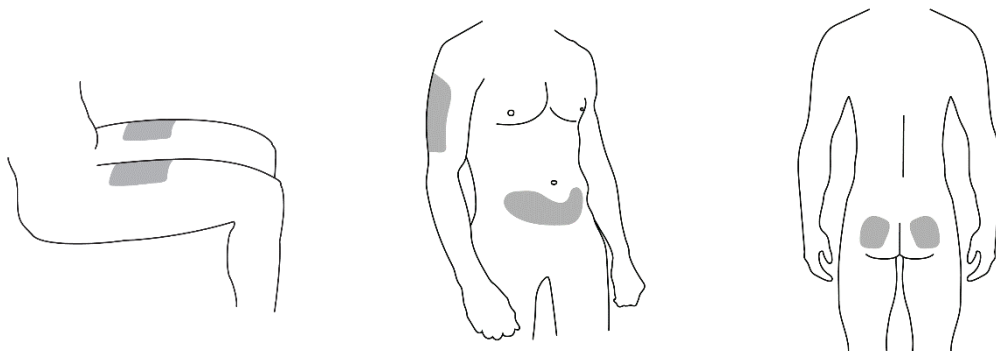

*Areas in gray are recommended injection sites.

Step 3: Inject OTULFI

- Remove the needle cover when you are ready to inject your OTULFI.
- **Do not** touch the plunger or plunger head while removing the needle cover.
- Hold the body of the prefilled syringe with one hand, and pull the needle cover straight off. (**See Figure D**)
- Put the needle cover in the trash.
- You may also see a drop of liquid at the end of the needle. This is normal.
- **Do not** touch the needle or let it touch anything.
- **Do not** use the prefilled syringe if it is dropped without the needle cover in place or if it is dropped onto a hard surface. Call your doctor, nurse or health professional for instructions.

Figure D

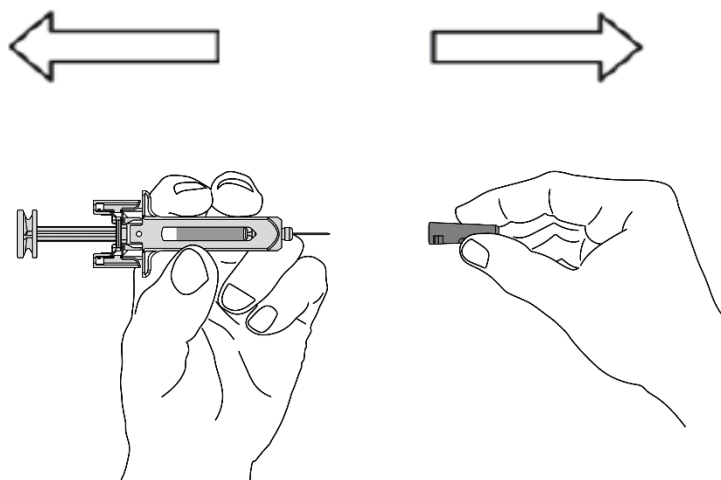

- Hold the body of the prefilled syringe in one hand between the thumb and index fingers. (**See Figure E**)

Figure E

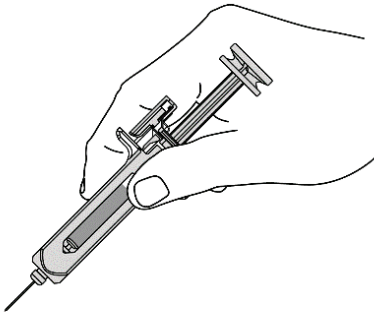

- **Do not** pull back on the plunger at any time.
- Use the other hand to gently pinch the cleaned area of skin. Hold firmly.
- Use a quick, dart-like motion to insert the needle into the pinched skin at about a 45-degree angle. (**See Figure F**)

Figure F

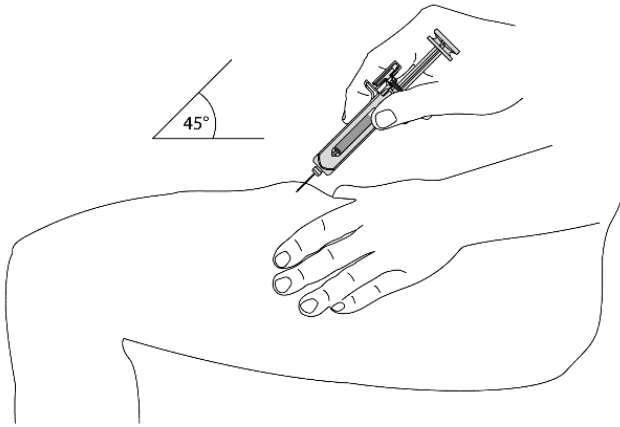

- Inject all of the liquid by using your thumb to push in the plunger until the plunger head is completely between the needle guard wings. (**See Figure G**)

Figure G



- When the plunger is pushed as far as it will go, keep pressure on the plunger head. Take the needle out of the skin and let go of the skin.
- Slowly take your thumb off the plunger head. This will let the empty syringe move up until the entire needle is covered by the needle guard. (**See Figure H**)

Figure H

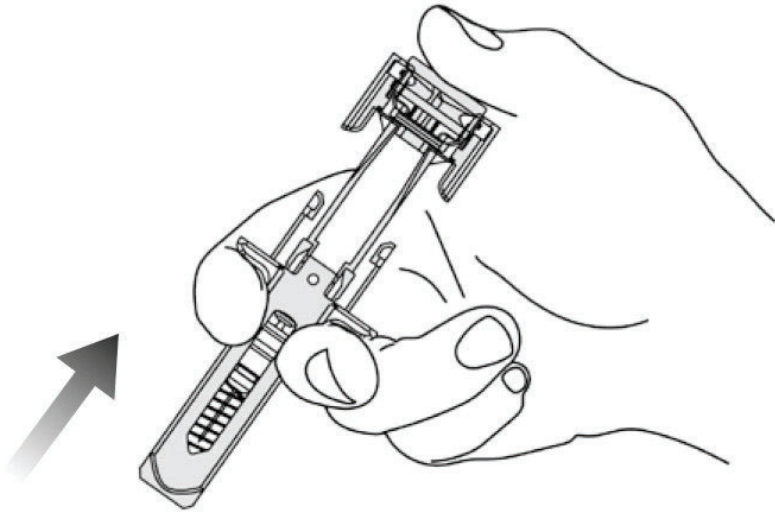

- When the needle is pulled out of your skin, there may be a little bleeding at the injection site. This is normal. You can press a cotton ball or gauze pad to the injection site if needed. Do not rub the injection site. You may cover the injection site with a small adhesive bandage, if necessary.

If your dose is 90 mg, you will receive either one 90 mg prefilled syringe or two 45 mg prefilled syringes. If you receive two 45 mg prefilled syringes for a 90 mg dose, you will need to give yourself a second injection right after the first. Repeat Steps 1–3 for the second injection using a new syringe. Choose a different site for the second injection.

Step 4: Dispose of the syringe.

- Put the syringe in an FDA-cleared sharps disposal container right away after use. **Do not throw away (dispose of) loose syringes in your household trash.**
- If you do not have an FDA-cleared sharps disposal container, you may use a household container that is:
 - made of heavy-duty plastic.
 - can be closed with a tight-fitting, puncture-resistant lid, without sharps being able to come out.
 - upright and stable during use,
 - leak-resistant,
 - and properly labeled to warn of hazardous waste inside the container.
- When your sharps disposal container is almost full, you will need to follow your community guidelines for the right way to dispose of your sharps disposal container. There may be local or state laws about how to throw away syringes and needles. For more information about safe sharps disposal, and for specific information about sharps disposal in the state that you live in, go to the FDA's website at: <http://www.fda.gov/safesharpsdisposal>.
- Do not dispose of your sharps disposal container in your household trash unless your community guidelines permit this. Do not recycle your sharps disposal container.
- If you have any questions, talk to your doctor or pharmacist.

Keep OTULFI and all medicines out of the reach of children.

Manufactured by:

Fresenius Kabi USA, LLC, Lake Zurich, IL 60047, U.S.A, US License Number 2146

This Instructions for Use has been approved by the U.S. Food and Drug Administration.

Revised: 02/2025